

**ARMY
NAVY
AIR FORCE**

**TM 5-630
NAVFAC MO-100.1
AFM 126-2**

**NATURAL RESOURCES
LAND MANAGEMENT**

**DEPARTMENTS OF THE ARMY, THE NAVY, AND THE AIR FORCE
JULY 1982**

FOREWORD

This manual, together with the following manuals, provides guidance, standards and technical information to personnel concerned with the protection and management of Natural Resources at Department of Defense installations:

Forest Management-TM 5-631, AFM 126-3, and NAVFAC MO-100.2

Fish and Wildlife Management-TM 5-633, AFM 126-4, and NAVFAC MO-100.3

Outdoor Recreation and Cultural Values-TM 5-635, AFM 126-5, and NAVFAC MO-100.4

Advice concerning any procedure within this manual may be obtained from:

- a. Department of the Army-Office of the Chief of Engineers (DAEN-MPO-B)
- b. Department of the Air Force-Directorate of Engineering and Services AFILEEV
- c. Department of the Navy-Naval Facilities Engineering Command (2042), or its Geographic Engineering Field Division (243).

Recommendations or suggestions for modification, or additional information and instructions that will improve the publication and motivate its use, are invited and should be submitted through appropriate channels to the addresses listed above.

TECHNICAL MANUAL
 No. 5-630
 AIR FORCE MANUAL
 NO.126-2
 NAVFAC MO-100-1



DEPARTMENT OF THE ARMY,
 THE AIR FORCE, AND THE NAVY.
 WASHINGTON, DC, 1 July 1982

**NATURAL RESOURCES
 LAND MANAGEMENT**

**Table of Contents
 PART I. GENERAL**

		Paragraph	Page
CHAPTER	1. INTRODUCTION		
	Purpose	1-1	1-1
	Scope	1-2	1-1
	Environmental Considerations	1-3	1-1
	Proponent and User Comments.....	1-4	1-1
CHAPTER	2. NATURAL RESOURCES MANAGEMENT PROGRAM		
	Definition	2-1	2-1
	Objectives.....	2-2	2-1
	Responsibilities	2-3	2-1
	Supervision and Staffing	2-4	2-1
	Technical Assistance	2-5	2-1
	Classification of Grounds	2-6	2-2
	Multiple Use.....	2-7	2-3
CHAPTER	3. NATURAL RESOURCES MANAGEMENT PLANS		
	Long Range Planning.....	3-1	3-1
	Annual Increments/Work Plans	3-2	3-1
	Records and Reports	3-3	3-1
CHAPTER	4. CLIMATE		
	Factors Affecting Plants	4-1	4-1
	Climatic Regions	4-2	4-2
	Precipitation Effect on Land Management	4-3	4-5
	Temperature Effect on Land Management	4-4	4-6
CHAPTER	5. SOILS		
	Evaluation of Soil.....	5-1	5-1
	Soil Depth.....	5-2	5-1
	Texture of Soil	5-3	5-2
	Fertility of Soil.....	5-4	5-2
	Soil Surveys and Land Use Capabilities.....	5-5	5-4
CHAPTER	6. DRAINAGE		
	Importance and Factors of Drainage.....	6-1	6-1
	Watershed Improvement.....	6-2	6-1
	Drainage Systems.....	6-3	6-1
	Design and Construction	6-4	6-2
	Maintenance.....	6-5	6-2

*This Manual supersedes TM 5-630, Dec 1967/AFM 85-6, Aug 1963/NAVDOKS MO-100 and MO-101, Sep and Dec 1963.

			Paragraph	Page
CHAPTER	7.	SOIL EROSION		
		Water Erosion Control	7-1	7-1
		Wind Erosion and Dust Control	7-2	7-1
		Shoreline Stabilization	7-3	7-10
		Sand Dune Control	7-4	7-11
		Environmental Protection During Pre-Construction and Construction Actions	7-5	7-12
CHAPTER	8.	FERTILIZERS AN AMENDMENTS		
		Nutrient Requirements of Plants	8-1	8-1
		Fertilizers	8-2	8-1
		Soil Amendments	8-3	8-5
CHAPTER	9.	INSECTS DISEASE AND ANIMAL PESTS OF VEGETATION		
		General	9-1	9-1
		Insects	9-2	9-1
		Diseases	9-3	9-1
		Animal Pests	9-4	9-3
CHAPTER	10.	FIRE PROTECTION ON MILITARY LANDS		
		Fire Prevention	10-1	1-1
		Preparedness or Presuppression Activities	10-2	10-1
		Fire Suppression	10-3	10-21
		Fire Reports	10-4	10-29
CHAPTER	11.	VEGETATION CONTROL		
		Weed Types and Situations	11-1	11-1
		Cultural Practices	11-2	11-2
		Herbicides	11-3	11-3
		Plant Growth Retardants	11-4	11-6
CHAPTER	12.	EQUIPMENT		
		Requirements	12-1	12-1
		Care of Equipment	12-2	12-9
CHAPTER	13.	POLLUTANTS AFFECTING PLANTS		
		Definition	13-1	13-1
		Soil, Water and Foliar Pollutants	13-2	13-1
		Air Pollutants	13-3	13-3
CHAPTER	14.	SAFETY		
		Management and Administration	14-1	14-1
		Health and Environment	14-2	14-1
		Protective Clothing and Equipment	14-3	14-1
		Pesticides	14-4	14-1
		Poisonous Plants	14-5	14-2
		Equipment	14-6	14-3
PART II. LAND MANAGEMENT AND GROUNDS MAINTENANCE				
CHAPTER	15.	ESTABLISHMENT AND MAINTENANCE OF GROUNDS		
		General Provisions	15-1	15-1
		Critical Plant and Animal Habitats	15-2	15-1
		Special Interest Areas	15-3	15-1
		Preventive Maintenance	15-4	15-1
		Grasses and Legumes	15-5	15-2
		Trees, Shrubs, Ground Covers and Vines	15-6	15-26
		Golf Course Maintenance	15-7	15-45
		Airfield Maintenance	15-8	15-47
		Roadside Vegetation	15-9	15-47
		Maintenance of Antenna Facilities	15-10	15-48
		Magazines (Earth Covered) Maintenance	15-11	15-50
		Reclamation of Drastically Disturbed Areas	15-12	15-51
		Mowing	15-13	15-56

CHAPTER	16.	IRRIGATION	Paragraph	Page
		Introduction	16-1	16-1
		Water Source Alternatives	16-2	16-2
		Determination of Irrigation Requirements	16-3	16-4
		Distribution Selection Alternatives.....	16-4	16-5
		Distribution Design for Piped Systems.....	16-5	16-6
		System Operations.....	16-6	16-7
CHAPTER	17.	OUTLEASES AND SERVICE CONTRACT AREAS		
		Agricultural Leases.....	17-1	17-1
		Maintenance Service Contracts	17-2	17-1
APPENDIX	A.	References.....		A-1
APPENDIX	B.	Natural Resources Management Plan, Outline for Part I-General.....		B-1
APPENDIX	C.	Natural Resources Management Plan, Outline for Part II-Land Management and Grounds Maintenance		C-1
		Annex I-Landscape Planting Plan		
		Annex II-Annual Work Plan		
APPENDIX	D.	Technical Assistance		D-1
APPENDIX	E.	Bibliography.....		E-1
APPENDIX	F.	Sample Agreement for Fire Suppression Service and Equipment.....		F-1
APPENDIX	G.	Example of Cooperative Agreement		G-1
APPENDIX	H.	Natural Resources Fire Protection Plan.....		H-1
APPENDIX	I.	Woodland and Grass Fire Report, DA Form 3985 (Sample)		I-1
APPENDIX	J.	Hydro-Mulching		J-1
APPENDIX	K.	Specification Guidelines for Hydro-Mulching.....		K-1
INDEX				Index-1

LIST OF ILLUSTRATIONS

<i>Figure</i>	<i>Title</i>	<i>Page</i>
4-1	Climatic Regions of Continental USA.....	4-4
4-2	Warm Season Precipitation	4-6
4-3	Frost-Free Days	4-7
5-1	Soil Auger and Soil Tube	5-1
5-2	Classification of Soil.....	5-2
5-3	The pH Scale	5-4
7-1	Sediment Basin on a Construction Site.....	7-1
7-2	Method of Preserving Trees When Grade is Raised (with dry well)	7-18
7-3	Method of Preserving Trees When Grade is Raised (without dry well)	7-18
7-4	Method of Preserving Trees When Grade is Lowered.....	7-18
10-1	Fir Lookout Tower	10-2
10-2	Firefinder	10-3
10-3	Fire Protection Grid Map.....	10-4
10-4	Fire Locator Grid	10-5
10-5	Locating a Fire at Intersection of Readings.....	10-6
10-6	Prescribed Burning in Progress	10-7
10-7	Backfire Technique	10-9
10-8	Strip-Head Fire Technique.....	10-10

<i>Figure</i>	<i>Title</i>	<i>Page</i>
10-9	Ring Fire Technique.....	10-11
10-10	Hardwood Kill Comparison (summer vs. winter fire).....	10-12
10-11	Fire-Line Construction Using Heavy Fir-Line Plow.....	10-13
10-12	Vegetated Firebreak with Rock Surfaced Patrol Road	10-14
10-13	Loading Light Tractor with Fire Plow Attached.....	10-15
10-14	Fire-Fighting Equipment on Transport Tilt Bed Trailer.....	10-16
10-15	Hand Tools in General Use for Forest and Grass-Fire Suppression	10-18
10-16	Testing Water Bucket of Chinook Helicopter.....	10-20
10-17	The Fire Triangle.....	10-21
10-18	Breaking the Fire Triangle.....	10-22
10-19	Hillside Fire-Line Construction Designed to Stop Rolling Embers.....	10-22
10-20	Small Fire Tactics	10-23
10-21	Tactics When Only One Tractor-Plow Unit is Available	10-23
10-22	Tactics When Two Tractor Plow Units are Available	10-24
10-23	Alternate Tactics for Use of Two Tractor-Plow Units	10-24
10-24	Hand-Tool Tactics	10-26
10-25	Good and Bad Backfiring	10-28
15-1	Zones of Adaptation for Grasses (1-18).....	15-15
15-2	Planting Zones for Grasses	15-26
15-3	Zones for Windbreak and Landscape Plantings	15-28
15-4	Removing a Limb	15-44
15-5	Bark Tracing of Abrasion on Trunk of Tree.....	15-44
15-6	Sanitary Landfill with Topsoil Replaced and Revegetated as Fill is Completed.....	15-51
16-1	A Permanent Irrigation System in Operation.....	16-2

List of Tables

<i>Figure</i>	<i>Title</i>	<i>Page</i>
7-1	Organic Mulches	7-3
7-2	Inorganic Mulches	7-8
9-1	Effective Fungicides for Disease Control in Landscape Planting.....	9-3
10-1	Rates of Drill Sowing on Suitable Sites by Species and Climate.....	10-8
10-2	List of Fire Tools/Supplies for Use with Tractor-Plow on Wildland Fires	10-19
10-3	List of Fire Tools/Supplies for Use by Handline Crews on Wildland Fires	10-19
11-1	Effective Herbicides for Landscape Planting	11-3
11-2	Effective Herbicides for Edging and Spot Sterilization.....	11-5
12-1	Suggested List of Grounds Maintenance Equipment.....	12-1
12-2	Payback Period	12-9
12-3	Figuring Mowing Costs.....	12-9
12-4	Oil Classifications.....	12-12
13-1	Tolerance of Some Plants to Salt and Salt Spray.....	13-1
14-1	Some Selected Poisonous Plants	14-1
15-1	Seeding Rate Table	15-4
15-2	Spacing of Trees and Shrubs	15-27
15-3	Ground Cover Plants.....	15-35
16-1	Water Holding Capabilities and Infiltration Rates of Various Soil Textures	16-4
B-1	Inventory of Land Use	B-2

**PART I. GENERAL
CHAPTER 1.
INTRODUCTION**

1-1. Purpose. This manual provides technical information for personnel engaged in land management and grounds maintenance on Department of Defense installations. It consolidates and modernizes criteria which were in each of the military service natural resources management and maintenance manuals. Properly applied, the principles and practices prescribed in this manual will supplement ongoing management efforts, conserve the natural resources on Department of Defense lands, maintain and improve the appearance of grounds and promote operational safety and efficiency.

1-2. Scope. This manual deals with frequent problems regarding the conservation and management of natural resources under Department of Defense jurisdiction, world wide. Installations and facilities outside United States and its possessions will coordinate management and maintenance activities with the host country. The manual also provides soil, climate and cultural information relating to land management and grounds maintenance. It provides plant adaptability lists for the major plant growth regions of continental US. It discusses techniques for natural resources management

under a wide range of conditions, including measures for wind and water erosion control, vegetative insect and disease control, weed control and drainage improvement. Included are: bibliography; relevant references, common and scientific names of plants adaptable to Department of Defense lands; and pertinent tables and figures.

1-3. Environmental Considerations. Applicable portions of environmental statutes, implementing regulations and Executive Orders as set forth in AR 200-1; AFR 19-2; MCO P11000.8 and OPNAV INST 6240.3E (app. A, No. 1) will be compiled with.

1-4. Proponent and User Comments. The proponent agency of this manual is the Office of the Chief of Engineers, Department of the Army. Users are invited to send comments and suggested improvements on DA Form 2028 (Recommended Changes to Publications and Blank Forms) to HQDA (DAEN-MPO-B) WASH DC 20314.

CHAPTER 2. NATURAL RESOURCES MANAGEMENT PROGRAM

2-1. Definition. Natural resources management is the program for development, improvement, maintenance and conservation of the real property of DOD installations. Application includes control measures for: wind and water erosion and sedimentation; insects and diseases harmful to vegetation; excessive and undesirable vegetation; fire hazards and pollution. Maintenance and improvement practices include: care and development of turf and landscape trees and shrubs; agricultural outlease areas; soil stabilization; irrigation; land drainage; and natural resources management plans.

2-2. Objectives.

2-2.1. Conserve, develop, manage and maintain all land (includes soil, ground cover, and water areas) under DOD jurisdiction in accordance with proven scientific methods, procedures and techniques to facilitate military missions and operations.

2-2.2. Protect land investments from depreciation by adopting land use practices based upon soil capabilities.

2-2.3. Remove or screen unsightly debris or landscape blemishes.

2-2.4. Prevent installations from contributing to pollution through waste disposal or erosional debris.

2-2.5. Improve the appearance of installations and facilities through the preservation of the natural terrain and vegetation and by appropriate new plantings.

2-2.6. Prevent damage or destruction of valuable natural resources through fire or misuse.

2-3. Responsibilities.

2-3.1. Commanders at all levels are responsible for the conservation, improvement and management of all natural resources under their jurisdiction.

2-3.2 Major responsibilities of the military services, major commands and installation commanders are included in applicable directives of each of the military services.

2-4. Supervision and Staffing.

Many problems in the management of natural resources require special knowledge and technical skills. Technical guidance necessary to implement DOD policies for the

management of nature resources is provided by staffing with professional personnel to supervise the various program elements. The number and discipline of installation personnel will be dependent upon the scope of programs. Criteria for supervision and staffing are included in applicable directives of each of the military services.

2-5. Technical Assistance.

2-5.1. A valuable source of assistance is provided by specialists from major command headquarters and support commands. Such guidance involves policies, standards, procedures and periodic on-site advice in resolving technical problems and in establishing goals to implement management plans.

2-5.2. Periodic consultation with specialists in related disciplines is essential to resolve specific problems. The following specialists are most frequently needed:

2-5.2.1. Agronomists (grounds maintenance and management).

2-5.2.2. Agricultural engineers and hydrologists (topography, drainage and flood control).

2-5.2.3. Soil conservationists (soil interpretation and conservation measures for wind and water erosion control).

2-5.2.4. State and county extension specialists (pasture and agricultural crop recommendations). Note: Several of the following specialists are employed by the agricultural extension service.

2-5.2.5. Land appraisers (agricultural outleases).

2-5.2.6. Turf specialists (lawns, athletic fields and golf course maintenance).

2-5.2.7 Golf course architects (design and installation).

2-5.2.8. Landscape architects (design and planting plans).

2-5.2.9. Horticulturists (selection, culture and management of ornamental plants).

- 2-52.10. Foresters (forest management).
- 2-5.2.11. Tree surgeons (pruning and repair of injuries).
- 2-5.2.12. Biologists (plant, fish and wildlife management).
- 2-5.2.13. Entomologists (insect identification and control).
- 2-5.2.14. Plant pathologists (identification and control of diseases).
- 2-5.2.15. Herbicide specialists (control of weeds).
- 2-5.2.16. Equipment specialists (selection and operation).
- 2-5.2.17. Community planners and site planners (overall planning)

2-5.3. Supplementary assistance is generally available from appropriate natural resources management agencies (Federal, State, or County). This assistance is commonly available through memoranda of understanding at the DOD level and cooperative agreements at the installation level. Criteria for memoranda of understanding and cooperative agreements are included in applicable directives of each of the military services. Specific areas of major assistance available are as follows:

2-5.3.1. Federal Agencies

2-5.3.1.1 US Department of Agriculture. The 27 March, 1963 Memorandum of Understanding between DOD and USDA provides for the development of cooperative agreements between military installations and the Soil Conservation Service, Forest Service, or Agricultural Research Service of the USDA. The objective is to promote effective planning and application of a practical soil, water, forest and plant conservation program on DOD lands. Cooperative agreements can be developed with the Soil Conservation Service through the State Soil Conservationist for; soil surveys, land use capability classifications, range surveys, and on-site assistance in developing soil and water conservation plans. Agreements developed with the Forest Service through their regional foresters can provide assistance in forest management and windbreak plantings. The Agricultural Research Service can be called on to inaugurate research studies on unsolved problems and may assist in testing the research findings at the military installation involved.

2-5.3.1.2. US Department of the Interior. Assistance can be obtained from specific divisions of this department:

2-5.3.1.2.1. Fish and Wildlife Service—guidance in management of fish and wildlife, including animal damage control, bird strike hazards and protection of critical habitat for threatened and endangered species of

flora and fauna.

2-5.3.1.2.2. National Park Service—park and recreational planning and scenic enhancement.

2-5.3.1.2.3. Bureau of Land Management—irrigation criteria, land economics, grazing land data, alkaline-saline soils management.

2-5.3.1.2.4. Heritage Conservation and Recreation Service—management and maintenance of outdoor recreation resources and historic and other unique sites.

2-5.3.1.3. The National Weather Service and US Geologic Survey have pertinent data for each military installation.

2-5.3.2. State Agencies. Technical assistance is available from a number of state agencies. The principle ones involving land management considerations are Agricultural Experiment Stations, Extension Service, Land Grant Colleges, and Departments of Conservation and Natural Resources. The technical specialists employed by these agencies include: plant disease and insect specialists, authorities on crop varieties and culture, seed analysts, soil scientists, fertilizer technologists, and drainage and irrigation engineers. Many bulletins and other published material are obtainable through these agencies. On-site technical assistance can often be obtained from them too.

2-5.3.3. Private Industry. Private industry has developed valuable information on the products they produce and sell. Their publications describe their products and prescribe their best use and limitations. Some companies provide free consultation to their users. Commercial consulting firms can be hired to do specific jobs such as golf course design, irrigation design, soil stabilization and drainage, forest timber cruising and stand improvement, reforestation, aerial fertilization, seeding and weed control.

2-6. Classification of Grounds. Grounds consist of all land and water acreage for which an installation commander has responsibility (including outlying and satellite areas). Grounds are grouped into the following categories. (See AR 420-74, AFR 91-26 and NAVFAC P-73, (app A, no. 2).) 2-6.1. Improved Grounds. This category includes acreage on which intensive maintenance activities must be planned and performed

annually as fixed requirements. Included are areas within the built up section of an installation which contain lawns and landscape plants; parade grounds; drill fields; athletic facilities; cemeteries; golf courses (excluding roughs); and similar areas. Maintenance operations include mowing, irrigating, fertilizing, cultivating, aerifying, seeding, sodding, spraying, pruning, trimming, weed control, vegetative insect and disease control, planting for landscape effect, wind and sound abatement and other intensive practices.

2-6.2. Semi-improved Grounds. This category includes areas on which periodic recurring maintenance is performed but to a lesser degree than on improved grounds. Included are small arms ranges, antenna facilities, picnic areas, mowed road shoulders, golf course roughs, ammunition storage areas, airfield shoulders and clear zones, drop zones, firebreaks, and similar areas. Practices normally include such cyclic variables as soil sterilization, weed and brush control, erosion and dust control, drainage maintenance, and mowing for fire protection.

2-6.3. Unimproved Grounds. This category includes all other acreage not classified as improved or semi-improved. Included are bombing and gunnery areas; impact areas, training and maneuver areas; forest areas; agricultural and grazing lands, lakes, ponds and swamps; beach and similar areas requiring limited or no maintenance. Practices and intervals of attention are generally unpredictable such as might evolve from the military mission; soil, water and wildlife conservation, floods, fires, and insect or disease epidemics. There are often the most extensive land areas under military control and generally afford the greatest potential for the development of a natural resources management

program.

2-7. Multiple Use. Department of Defense has an obligation to the American people to act responsibly and effectively in the use of natural resources under military control. Multiple land use will be applied to the extent compatible with the military mission; to that end, the implementation of a natural resources program and the military mission need not and shall not be mutually exclusive. Use requirements for military land will be established in coordination with the installation master plan and as supported by the approved installation natural resources management plan. The designated use of the installation land dictates the intensity of management and the applicable principles and practices for environmental protection, natural resource conservation, pollution abatement and waste disposal, controlled public access for recreational uses, and for visual enhancement. The military mission determines the primary land use. Examples of multiple land use are:

2-7.1. Grazing ammunition storage areas which provides fire protection while reducing maintenance costs.

2-7.2. Erosion control plantings on slopes exposed to military personnel, or the public, utilizing plants which improve the appearance of the installation.

2-7.3. Impoundments for water supply, or flood control, and stocked with fish to provide recreational benefits.

2-7.4. Forest lands which provide maneuver areas and wildlife food and cover while producing timber products.

2-7.5. Agricultural outlease of buffer areas which provide income and benefits to the Government while providing safety zones.

CHAPTER 3.
NATURAL RESOURCES
MANAGEMENT PLANS

3-1. Long Range Planning

3-1.1. A prerequisite to the management and maintenance program is the development and implementation of a natural resources management plan.

3-1.2. The natural resources management plan will include the following parts, as applicable: Part I-General, and Part II-Land Management and Grounds Maintenance, including an annex for the Landscape Planting Plan; Part III, Forest Management; Part IV, Fish and Wildlife Management; and Part V, Outdoor Recreation and Cultural Values. See appendixes B and C for outlines for Parts I and II. Outlines for Parts III, IV, and V are contained in publications at appendix A, no. 3, no. 4, and no. 5, respectively. The plan is organized around the military mission requirements for land and an inventory classification of the installation land area (Improved, semi-improved and unimproved grounds*). Grounds classification may be refined to address management alternatives and objectives for implementing a natural resources program. The resources include intensively used grounds; areas available for agricultural or grazing purposes; economically productive forest land; fish and wildlife management areas; and outdoor recreation and cultural resources. The plan will include an environmental assessment.

3-2. Annual Increments/Work Plans. Segments of the natural resources management plan are to be scheduled for implementation each year. Projects to be undertaken

are set forth in annual work plans. This work involves special projects and high priority items outlined in the long range plan, all major recurring work and revisions necessitated by operational changes of the installation, required repairs caused by unpredictable weather, fire or other factors. The annual work plans must be prepared in advance of the fiscal year in which the work is scheduled to assure adequate supplies, materials, equipment, manpower and funds. The annual work plans will be coordinated with the installation master plan for land utilization; with the installation conservation and beautification committee; and with cooperative agreements formalized with Federal, State and local natural resources conservation agencies. The annual work plans will be prepared utilizing guidelines contained in applicable directives of each of the military services. (See annex II to app. C for annual work plan format).

3-3. Records and Reports. Specific requirements for record keeping will be governed by directives issued by each of the military services. Annual plans and accomplishments (ref para 3-2 above) are prime sources of records and data for essential reports. Accomplishments include projects completed, supplies and materials used, costs, monetary benefits from forest product sales and from outleased lands, and personnel training and safety programs specific to natural resources management.

* Forest land areas are included with unimproved grounds.

CHAPTER 4. CLIMATE

4-1. Factors Affecting Plants. Climate is a major factor in determining the species of plants that can be grown. The plant kingdom has become adapted to a wide range of temperatures, precipitation, light exposure, day length and wind. Each of these climatic factors is extremely important in selecting plants to tolerate particular local situations.

4-1.1. Temperature. Temperature influences every chemical and physical process connected with plants and limits to a considerable extent the distribution of plants. Many plants can survive great extremes of temperature by entering resting stages. The temperature range within which growth takes place is much more limited.

4-1.1.1. Temperatures that cause the highest growth rate are not necessarily the most favorable for the general welfare of the plant. Too rapid growth may cause plants to be structurally weak, irregularly shaped, susceptible to disease or insect attack and subject to damage by wind, hail or other adverse climatic influences.

4-1.1.2. Low temperature not only slows growth but when the temperature drops below freezing, plants are in danger of frost injury. Plants survive in cold regions in a number of ways. Annuals survive by completing their life cycle and producing seed during the frost free period. Herbaceous perennials die back to the ground but maintain life in underground organs such as bulbs, tubers, fleshy roots and underground stems called rhizomes. New shoots arise each spring to form new tops. Cold susceptible plants can be benefited by mulching with porous material.

4-1.1.3. Hardy plants tolerate cold by going dormant. The degree of cold tolerance varies with different species and varieties.

4-1.1.4. High temperatures may adversely affect plant growth. High temperatures are usually accompanied by high light intensity and rapid transpiration. When temperatures are above optimum for a species, growth slows and the plant becomes dwarfed. Excessively high temperatures may cause injury and death to areas on leaves, and cause discoloration and imperfections in flowers of ornamentals. General effects of excessive heat are leaf loss, premature dropping of fruits, and in extreme cases, death of the plant.

4-1.2. Water. Water is a necessity for growth of any

plant. Plants fall into three groups on the basis of the moisture condition to which they are adapted. These groups are: Hydrophytes-water dependent plants; Mesophytes-plants adapted to medium moisture conditions; and Xerophytes-plants which survive only under conditions of extreme moisture shortage.

4-1.2.1. Hydrophytes may grow in or under water. They can survive with the minimum of oxygen, but require an abundance of water at all times. Examples are cattails and water lilies.

4-1.2.2. The mesophytes require moderate soil moisture and a good supply of oxygen in the soil for normal development. They have moderately large root systems in proportion to the tops. Structurally they are fairly well protected against water loss through the tissues, therefore are able to make good use of the water which is available to them. Examples are oak trees, roses and bluegrass.

4-1.2.3. Xerophytes are plants highly resistant to drought conditions, having structures which reduce water loss to a minimum. Their leaves are small, with surface coverings which are thick and covered with waxy material. Such plants usually have large root systems in relation to the tops. Slow growing, they survive long periods of drought. Such plants are commonly found in the arid regions (deserts) where there is very limited rainfall at infrequent intervals. Plants in this group produce some feed for livestock and wildlife and are important in reducing soil erosion. Examples are cacti and sagebrush.

4-1.3. Light. Light has a significant effect on plant growth through most of a plants life cycle. The presence of light decreases and the absence of light increases the rate of stem elongation. If the light intensity is high the stems are short and sturdy, if low, the stems are often long and thin. Shade tolerant species respond less to low light intensities so retain their compactness far better than sun-loving species. Light is required in the manufacture of food by the plant for growth, flowering, and fruiting.

Insufficient light limits food production and storage.

4-1.3.1. Plants vary in their response to day length as well as to the light intensity. Plants which grow vegetatively during the long days of summer, and flower or go dormant in the short days, are called short-day plants. Others, just the opposite, are called long-day plants. Some are not sensitive to the lengths of day and night. Sensitivity to the relative length of day often varies among several varieties of the same kind of plant. An example is the chrysanthemum in which different varieties have different day length requirements.

4-1.3.2. Plants are sensitive to the quality and intensity of the light received while they are growing. Most plants grow best when in sunlight or partial sunlight where they may have the complete solar spectrum rather than a portion of it. Thus light intensity under natural conditions affects principally the type of growth and the amount of food the plant is able to produce for its use or for storage. Light intensity can be regulated to some degree by the location of the plant, such as the north or south exposure, or under partial shade. Select plants best suited for the amount and intensity of light to which they will be exposed.

4-1.4. *Wind.* Wind increases the water requirement of plants and reduces the effectiveness of rainfall. High winds can ruin crops, uproot trees, cause severe breakage, and may carry salt spray far inland causing defoliation and often death. High winds can expose root systems and redeposit the soil onto other plants. Winds are important in pollination, however, and carry fresh air to and through dense vegetation and reduce the amount of disease.

4-2. Climatic Regions. Discussion of management and maintenance practices in this manual will relate to 10 of the climatic regions in the Northern Hemisphere: Cool humid; warm humid; cool subhumid; warm subhumid; cool arid and semiarid; warm arid and semiarid; dry summer; rain forest; arctic and subarctic; and savanna. Distribution of the first seven regions in the continental United States is shown in figure 4-1. Relation of the regions to climatic adaptations of plants is not always definite, for some plants can be grown far beyond the normal regional limit adaptation because of a tolerance to variations in temperature, moisture, and soil. Temperature and moisture are the major climatic factors in soil and plant relationships in all regions. Since in many instances natural rainfall can be supplemented by irrigation, temperature may be considered of greater importance in connection with improved grounds treatment. The following characterizations of climatic

regions are limited to temperature, precipitation, and a few general remarks on vegetation.

4-2.1. *Regions within Continental United States.*

4-2.1.1. *Cool humid.* The northeast region of Continental United States has frequent rains during the warm season, sufficient for vigorous growth of grasses and grains. Annual precipitation for most of the area is in excess of 30 inches, with 15 to 25 inches falling from April to September, inclusive. The region in the Pacific Northwest is also cool and humid but precipitation occurs principally during the winter. The summer is relatively dry. Winter temperatures are mild so grass grows during the humid portions of the year. The frost-free period varies from less than 120 days on the northern border to about 200 days in the southern sector.

4-2.1.2. *Warm humid.* This region occupies the southeastern portion of Continental United States and has an annual rainfall of 35 to 60 inches. The moisture supply is generally adequate for growth of plants in all seasons and growth is controlled primarily by the length of the warm season suitable for southern plants. The frost-free period ranges from 180 days on the northern side of the region to more than 300 days on the Gulf Coast.

4-2.1.3. *Cool subhumid* This region includes the northern plains region from Kansas and Colorado to Canada, and the Palouse areas of eastern Washington, Oregon, and adjoining section of Idaho. Annual rainfall of the region ranges from 15 to 25 inches. More than half of this rainfall occurs during the growing season. The frost-free period varies from 100 to 180 days. In the Palouse area rains usually occur in winter and early spring and perennial grasses grow during the warm season on moisture accumulated in the soil during the rainy season. Since the dependability of average rainfall is much lower than in the humid regions, plants must be chosen that are capable of surviving extended periods of dry weather. Under irrigation all of the grasses suited to the cool humid region flourish in the subhumid areas since temperature ranges are similar in both areas.

4-2.1.4. *Warm subhumid.* This region covers the southern extension of the Great Plains from Colorado and Kansas, across Oklahoma and Texas to the Gulf of Mexico. Total annual precipitation and the rainfall in the warm season are the same as in most of the northern Great Plains, but the moisture is less effective because of

higher average temperatures and greater losses of moisture by evaporation. Annual rainfall varies from 15 to 30 inches and 50 percent or more of this occurs from April to September, inclusive. The length of the growing season varies from 180 to 200 days. Periodic droughts occur more frequently than in other areas to the north and east; hence, more careful planning and accurate timing of operations are required in establishing perennial plantings.

4-2.1.5. Cool arid and semiarid. The cooler section of the arid and semi-arid region of Continental United States averages 5 to 20 inches of precipitation yearly. In much of this area, at least half of this moisture falls during the cool months of the year and on permeable soils it may be absorbed and retained for utilization by growing plants. Although the atmosphere is prevailing dry, evaporation rates are much lower than in southern regions with similar rainfall.

4-2.1.6. Warm arid and semiarid. Annual precipitation in this region ranges from 5 to 20 inches, but high evaporation rates reduce the effectiveness of that portion of the rainfall occurring during the warm months. Thus, winter precipitation is the principal source of moisture for growth of native species, and vegetation becomes dormant after soil moisture is exhausted in spring and summer.

4-2.1.7. Dry summer. This climate occurs in the coastal area of southern California. It is distinguished from the climate of the warm arid and semiarid region by the concentration of all rainfall in winter and early spring and by the comparatively high humidity of the air at all seasons, particularly the warm season. The climate of this area is similar to that of the Mediterranean and Near

East regions of the world.

4-2.2. Special Climatic Regions Outside Continental United States.

4-2.2.1. Superhumid. This is a tropical climate characterized by ample rainfall at all seasons and continuously warm temperatures never falling below 50 degrees Fahrenheit. The relative humidity is high and loss of moisture to the air from plants and soil is low. These continuously warm, moist conditions permit a vigorous growth of trees, climbing plants, and herbaceous plants which results in a dense ground cover.

4-2.2.2. Arctic and subarctic. The state of Alaska may be divided into three areas showing the variety of conditions encountered in this climatic region.

4-2.22.1. The interior valley of Alaska includes most of the southeastern Yukon Valley and its tributaries. The taiga forest of this area extends southward into Canada, but northward the density and size of trees decreases to a zone of scattered stunted trees intermixed with treeless tundra. The interior valley has 7 to 15 inches of precipitation fairly well distributed throughout the year. Since very little moisture is lost by evaporation, this limited precipitation supports plant growth to the extent that species are able to grow at the low prevailing temperatures. The frost-free period in the Yukon Valley is very short (60 to 90 days), although the temperature sometimes reaches 90 to 100 degrees. Winters are long and cold with temperatures averaging 10 to 20 degrees below zero.

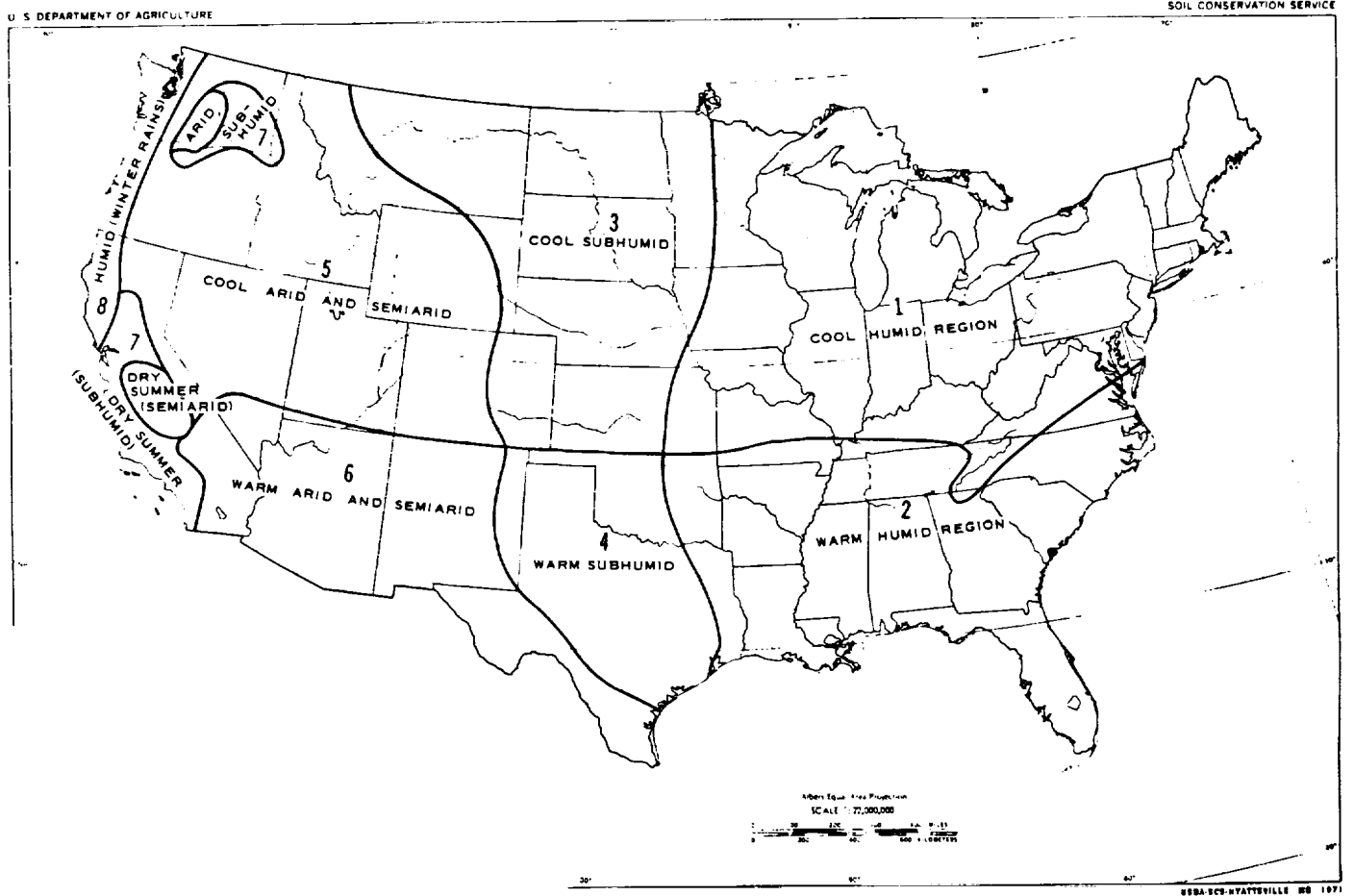

Figure 4-1. Climatic regions of continental USA

4-2.22.2. The Alaskan Peninsula and the Aleutian Islands have an annual precipitation of 30 to 70 inches well distributed throughout the year, but somewhat lighter in the summer months. The frost-free period is variable, but may be as much as 150 days on some islands. Temperatures on the peninsula rarely rise to 70 degrees in summer or go below zero in winter. On the island chain the climate is more uniform, rarely going below 20 degrees in winter or higher than 50 degrees in summer. The predominant vegetation is tundra, composed of mosses, lichens, and sedges intermixed with low-growing grasses.

4-2.2.2.3. The knik and muskeg areas occupy Kodiak Island and the alluvial plain extending along the eastern and northern sides of Cook inlet, including the beaches and flats along the western side of Kenai Peninsula, in the valleys of the Matanuska and Susitna rivers. Annual precipitation varies from 15 to 30 inches. Summers are short, with about 110 days of frost-free weather at Anchorage. The winters are long and cold.

Native cover consists of the true knik and muskeg areas, in which sphagnum moss alternates with open spaces occupied by grasses, and forests of spruce, hemlock, birch and aspen.

4-2.2.3. *Savanna*. This is a tropical or sub-tropical grassland (subhumid to semiarid) containing scattered trees and drought resistant undergrowth. Although average rainfall ranges from 25 to 50 inches yearly, it occurs mostly in certain seasons; other portions of the year receive very little moisture. High evaporation rates greatly reduce the effectiveness of rainfall. Lowest temperatures rarely go below 50 degrees Fahrenheit and temperatures are favorable for tropical plant growth throughout the year. Hence, actual growth of plants is determined largely by the rainy period, and the dominant plant species are perennials that can endure protracted droughts or annuals that can complete the growth cycle during the season of the adequate moisture.

4-3. Precipitation Effect on Land Management

4-3.1. *Seasonal Distribution.* Total annual precipitation and gross seasonal distribution have been mentioned for each climatic region. Regional differences can be shown by comparing two stations with approximately the same total annual precipitation. Of the 15 inches at station A, 4 1/2 inches fall during the period October to April when growth is dormant. From May to September 10 1/2 inches occur when growth is active. At station B, the reverse occurs with 13 1/2 inches of precipitation during the fall and winter months and only 3 inches during the May to September period. Both stations need drought tolerant plants, but station B would have to plan for yearly irrigation.

4-3.1.1. Areas with cool summers and uniform rainfall distribution favor cool season grasses. With the same amount of rainfall but higher summer air and soil temperatures, the cool season grasses become dormant, opening the turf to invasion by weeds.

4-3.1.2. An entire season's bloom on spring flowering shrubs may be lost if there is a shortage of moisture during flower bud formation the previous fall. Light showers along with high temperatures and wind (common in early fall) are completely ineffective in supplying moisture to plants.

4-3.1.3. Precipitation in the form of snow may require removal from plants to avoid excess breakage as it settles. Selection of plants that shed or bend with snow should be given serious consideration in the snow belts. Placement beyond the zone where snow slides from roof tops is another point to bear in mind. The above indicates a few examples of the effect of time and kind of precipitation on the land management program.

4-3.2. *Duration and Intensity.* Both duration and intensity of a storm affect vegetation and soils. Should it drizzle for a week most of the rain will soak into the soil. A five inch rain lasting an hour will cause run-off within a few minutes due to lack of absorptive capacity of the soil. Should it continue to rain at the 5-inch per hour rate, flooding will probably occur, making it necessary to plan for storm run-off. Intensity influences effectiveness of rainfall. Unless the rain can enter the ground it is not available for plant use. Many slopes become dry even when the amount of rain has been adequate for flat land, since the run-off from slopes materially reduces that which is available.

4-3.3. *Seasons.* There are seasons when planting should be avoided. Each installation must establish opening and closing dates for planting and seeding contracts. Rainfall pattern as well as temperature may enter into these determinations. Questions to be resolved might well be:

Is the soil moisture adequate to permit germination?

Is the rainfall pattern at this time of year favorable for germination and establishment?

Is there enough soil moisture to carry new transplants through the winter months or will the plantings have to be irrigated?

Which season is the best for any given species?

Figure 4-2 gives the warm season precipitation for the Continental United States. The U. S. Department of Agriculture Year Book for 1941 (CLIMATE AND MAN) has maps for each state. These are only guide lines and should be augmented with local data as available.

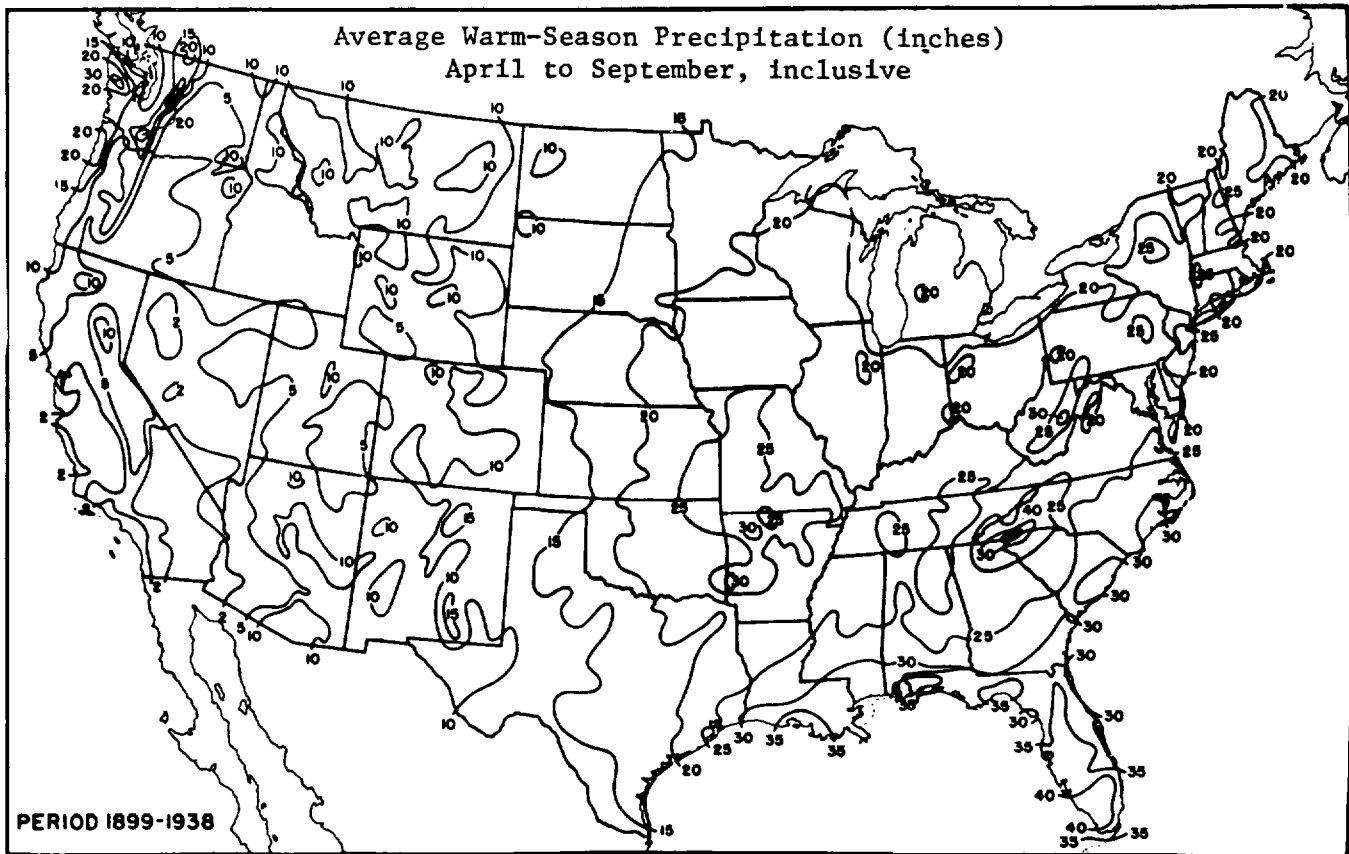

Figure 4-2.

4-4. Temperature Effect on Land Management

4-4.1. *Winter Kill and Ice.* Woody plants may have terminals killed back when the plants are not allowed to harden off properly. It often occurs when fertilizer is applied late in the growing season causing succulent growth to succumb to winter injury. Cold induced injury to tissues or internal structures of woody stems is common and is generally recognizable by discoloration of the affected part. "Black heart" is an extreme case of such injury in which pith and often one or more annual rings of wood will be dark colored, but not the cambium which produces new wood. Killing of the bark on trees and ornamental plants may occur at crotches, at the base of the trunk, and in patches variously located on branches and trunk. Frost cracks and splitting and loosening of bark are mechanical injuries to woody plants resulting from severe freezing.

4-4.1.1. Late spring frosts may damage or kill young tender plants. Flowers, shoots and leaves of ornamentals may be damaged such that their esthetic value is largely lost for the season.

4-4.1.2. Sun-scald is a cold injury occurring on the south and west sides of tree trunks and branches. In cold

weather, sunlight falling directly on the bark may create temperatures several degrees higher than shaded parts. At sunset the temperature drops suddenly and killing of the bark results. Shading or wrapping the trunk to reduce absorption of heat from the winter sun reduces the sun-scald type of injury.

4-4.1.3. Some indirect effects of low winter temperatures on plants are heaving of soil, resulting in breakage or exposure of roots; the smothering effect of ice sheets; and breaking of trees and shrubs by snow and sleet.

4-4.2. *Species Selection.* The reaction of different species of plants to temperature and temperature change must be understood prior to species selection. Some plants develop a deep winter dormancy while others fail to harden off and are subject to severe winter injury. Some plants will not renew growth or form seed heads unless they are subjected to periods of cold weather.

4-4.2.1. In some species seed does not germinate unless soil temperatures are cool. To attempt summer seeding of these species is to invite failure. Some species require a warm soil temperature for maximum germination. Other species function best when there is fluctuating cool and warm, which is common in the spring and fall. The grounds manager should know the characteristics of his plants and their specific reactions.

4-4.2.2. Native plants have proven their adaptability to a given location. Exotics must be proven over a period of years. Too often a warm cycle of a few years encourages the planting of non-adapted species which die when normal weather is resumed.

4-4.3. *Growing Seasons.* Growing season is usually defined as the number of days between the last killing frost in spring and the first killing frost in fall. In Hawaii there is no distinct growing season except at higher elevations. Growth is cyclic-new growth, a slow down when new buds are developed and increased activity when the new leaves emerge. On the dry sides of the islands, growth correlates to periods of rainfall. On the Pacific coast the winter growing season is also controlled by rainfall, not temperature. The number of frost-free days for Continental United States is shown in figure 4-3. More detail, by States, can be found in the 1941 Year Book of Agriculture (CLIMATE AND MAN).

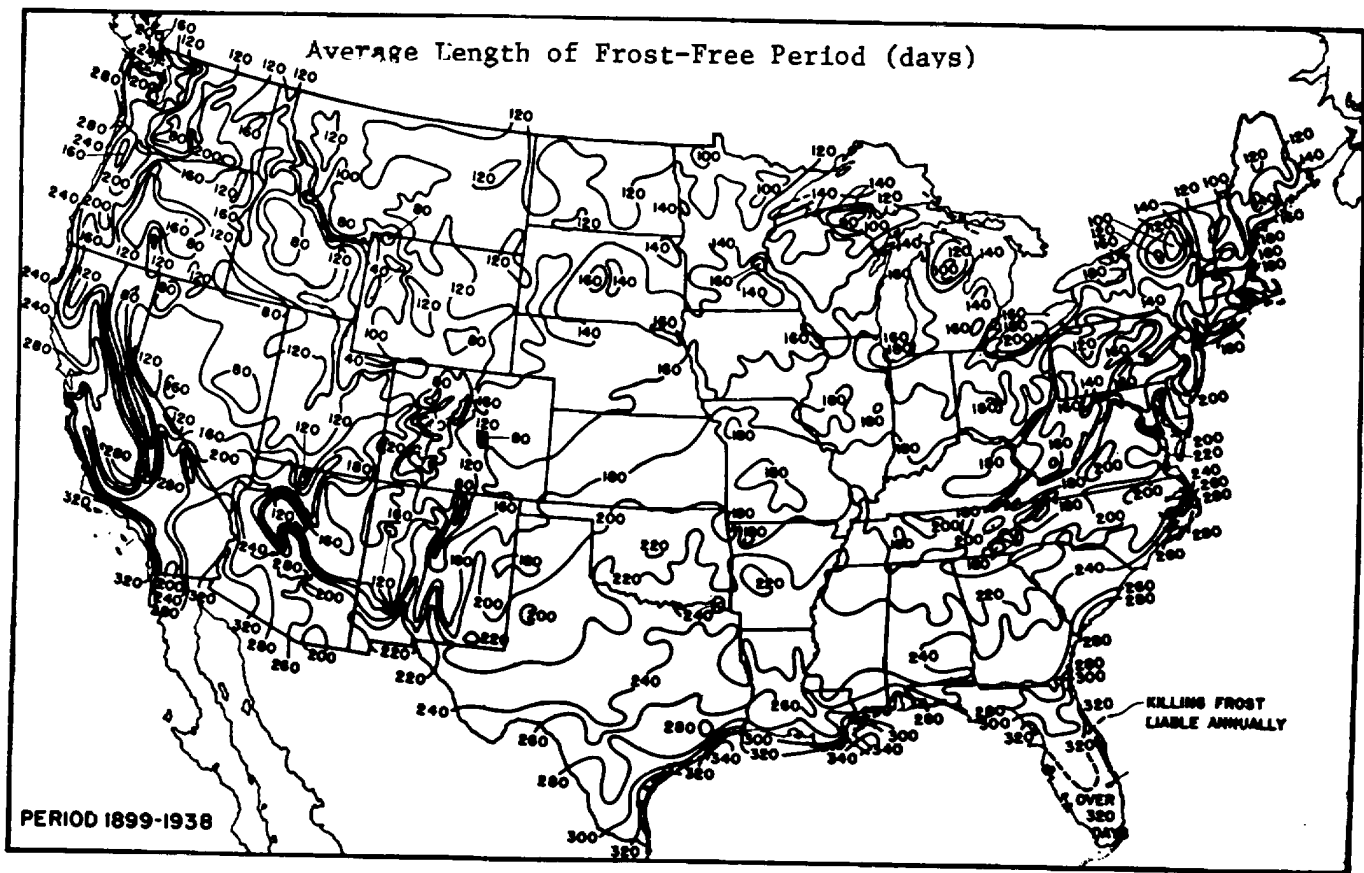

Figure 4-3. FROST MAP

CHAPTER 5. SOILS

5-1. Evaluation of Soil.

5-1.1. Understanding Soil A thorough understanding of soil characteristics and conditions is important to a successful planting program. Certain qualities of soils determine their ability to support plant growth. The texture of soil determines how well it can resist erosion and how much water can be stored for plant use. The physical and chemical composition of the soil determines how well plants will grow. Requirements for soil improvement depend upon the kinds and amounts of plant nutrients available in the soil.

5-1.2. Soil Analysis. Soil characteristics are determined by soil analysis. Obtain soil surveys from the United States Department of Agriculture, where they are available. Where extensive plantings are to be made, analyze and evaluate soils for the following:

- Depth of permeable soil and penetration of grass roots.

- Mechanical characteristics of surface soil and subsoil.

- Chemical characteristics of surface soil.

- Special characteristics, where applicable:

 - Toxic salts.

 - Organic matter.

 - Rate of water intake.

5-1.3. Made Land. This land type consists of areas where soil materials have been disturbed by fill or excavation. It is found in most housing and other construction areas and can be quite extensive at many military installations. Such land can no longer be identified by soil series, or as a single named soil and generally requires special treatment to establish and maintain vegetative cover.

5-2. Soil Depth.

The depth of soil is important in predicting the capability of soil to support plant growth. A minimum of two feet is desirable for plantings.

5-2.1. Determination of Soil Depth. The depth of soil may be observed in road cuts and embankments, or it may be obtained with a soil auger (fig. 5-1). Also, the penetration of grass roots indicates effective soil depth and gives the number of inches (or feet) in which water from rain or irrigation may be stored. Depth of roots should be observed at excavations recently made through typical grass areas. Deep roots indicate favorable soil structure (drainage, aeration, and texture).

5-2.2. Soil Profile. Well-developed, mature soils that have not been altered by construction or grading usually have well-defined layers called horizons which differ in color, texture, and structure. From the surface

downward, the series of horizons (A, B, and C) is called the soil profile. Some soil profiles show four feet or more of uniform dark color and texture without well-marked horizons. These soils are usually highly productive, but they may be subject to severe damage by erosion and must be protected from storm runoff. Other soils, such as those that cover impenetrable rock, shale, caliche, gravel, or hardpan, may be so shallow that they have no typical soil profile. Also, a high permanent water table or underlying coarse sand may prevent formation of a typical soil profile. On thousands of acres, soil and/or water erosion have removed all the A horizon and at

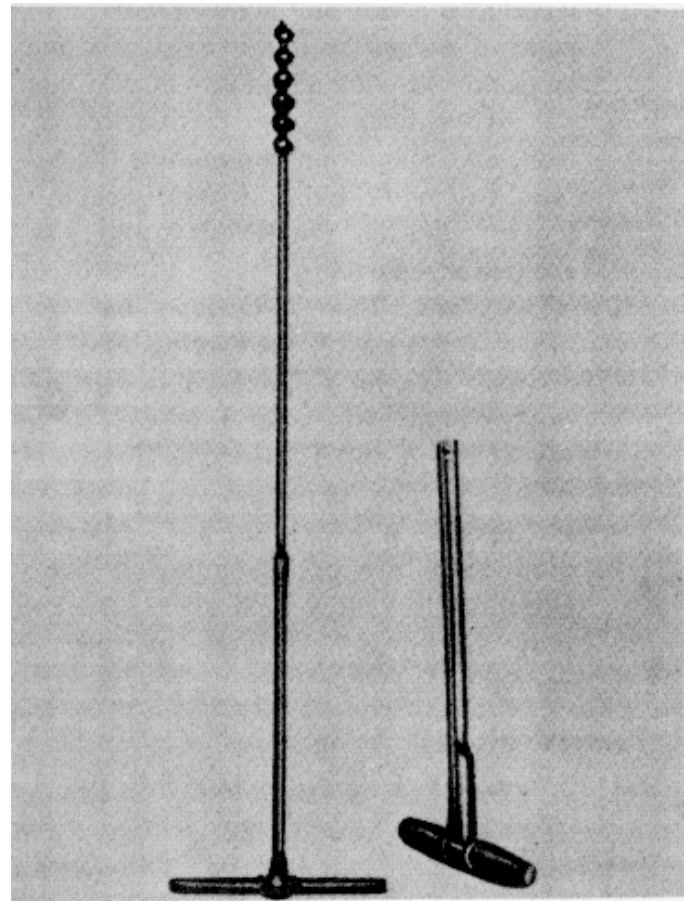

Figure 5-1. Soil auger and soil tube used to obtain samples for analysis, to locate soil layers, and to determine moisture penetration.

least part of the B horizon. Grounds maintenance supervisors often have to deal with B and C horizons only.

5-2.2.1. A Horizon. Typically, the A horizon consists of the upper 6 to 12 inches of weathered soil which contains most of the organic matter. It is more subject to change than the other horizons, for the soil-forming processes are most active in the surface layer.

5-2.2.2. B Horizon. The next layer, with less weathering and less root activity, is the B horizon. It may have a less granular (more block-like) structure. The B horizon receives materials from the A horizon as a result of the downward movement of water. In humid regions it may be darker in color and more closely compacted owing to greater content of clay, iron, and aluminum compounds. In subhumid to arid regions, it usually contains more alkaline materials and salt accumulations.

5-2.2.3. C Horizon. The C horizon has only minor evidence of weathering and root residue. If the C horizon consists of impervious materials, internal drainage of the A and B horizons is seriously impeded. The principal value of the C horizon is water storage. Although plant roots are not abundant in the C horizon, the water held there can support the plant through periods of drought.

5-3. Texture of Soil.

Soil consists of fragments varying in size from coarse particles (gravel and sand), to fine particles (silt), and very fine particles (clay). Classification of soil texture is based on the relative percentages of sand, silt, and clay, which are determined by mechanical analysis. In many localities accurate estimates of sand, silt, and clay in a sample can be made by soil technicians from the U.S. Soil Conservation Service. Excessive sand may prevent soils from retaining moisture and applied fertilizers. More than 50 percent of sand or sand and gravel may cause failure of cool-season grasses, especially in the southern parts of their adapted range or where the subsoils also have excessive sand or gravel. Clay loams retain three to six times as much water for plant use as sandy soils do. Soil with high clay content may be excessively plastic and unsuitable for physical training areas without some modification. Excessive silt (40 percent or more) causes poor interior drainage and shallow root penetration.

5-3.1. Particle Sizes. Diameters in millimeters of soil and gravel particles for various sizes according to the U.S. Department of Agriculture scheme--

Gravel.....	75 to 2.
Very coarse sand	2 to 1.0.
Coarse sand.....	1.0 to 0.5.
Medium sand.....	0.5 to 0.25.
Fine sand	0.25 to 0.10.
Very fine sand	0.10 to 0.05.

Silt.....	0.05 to 0.002.
Clay.....	Below 0.002.

5-3.2. Mechanical Analysis. Percentages of sand, silt, and clay are determined by mechanical analyses of soils, either by sieve tests or laboratory tests. Separate analyses may be necessary for surface soil and subsoil (A and B horizons), especially if the two horizons differ appreciably. When topsoil is to be used as a soil amendment it should be analyzed separately when texture data is required. Inquiry should be made, prior to obtaining soil samples for analysis, regarding procedure for taking samples and the preparation of samples for delivery to the laboratory.

5-3.3. Classification of Textures. Soil textures are classified and identified according to the percentage of sand, silt, and clay. As indicated in figure 5-2 a Sandy Clay Loam contains not less than 52 percent sand, not less than 20 percent clay, and not more than 28 percent silt; whereas, a Sandy Clay contains not less than 45 percent sand, not less than 35 percent clay, and not more than 20 percent silt.

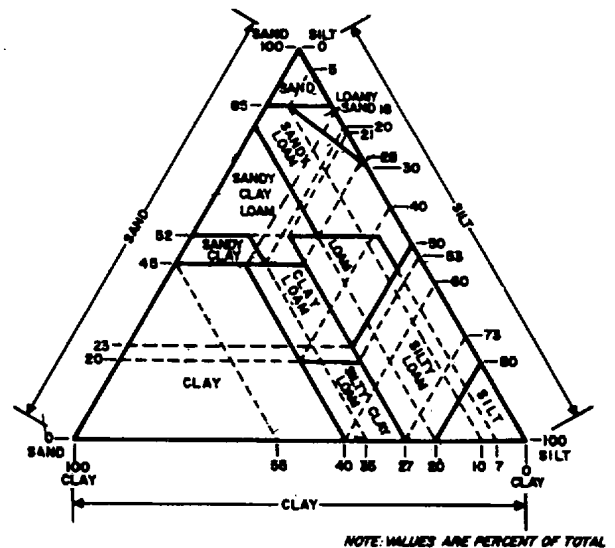

Figure 5-2. Classification of soil by percentages of sand, silt, and clay.

5-4. Fertility of Soil.

5-4.1. Factors Affecting Soil Fertility. Fertility of soil is dependent on the structure of the soil, the presence or absence of nutrients, and the degree of acidity or

acidity or alkalinity. The growth nutrients most likely to be deficient are nitrogen, phosphorus, and potash. Soil is sometimes deficient in magnesium, calcium, and iron. (See chap 8 Fertilizers and Amendments).

5-4.2. Tests for Soil Deficiencies. Soils are tested to determine the substances present and the conditions which affect plant growth. Most state agricultural experiment stations will make laboratory tests upon request. These tests serve primarily as guides. The USDA Agricultural Extension Service at the county level generally provides instructions on taking and submitting soil samples to the State Agricultural Experiment Station Soil Laboratory. Containers for the soil samples are often provided. Where fees are charged for soil testing, they are nominal; particularly when considering the reports made and recommendations provided for corrective action. Testing soils at the installation, by the use of field kits, is generally not recommended. Field (plot) tests at the installation, to determine fertilizer needs for turf grasses, are generally not recommended either when such determination can be made at the soil laboratory, above cited. Plot tests involving experimental fertilizers and soil amendments, to determine adaptability to local conditions, are encouraged where professional, or specifically trained personnel are available at the installation and when coordinated with the product manufacturer.

5-4.2.1. Tests for nitrogen. Due to the high solubility of nitrogen bearing material in the soil, laboratory tests for nitrogen are recommended only in geographic areas where the annual precipitation is under 20 inches per year. Consult the USDA Agricultural Extension Service at the county level, for nitrogen application recommendations based upon State Agricultural experiment station test results.

5-4.2.2. Tests for phosphorus and potash. Most laboratory reports give phosphoric acid and potash in pounds per acre. The amounts of soluble rather than available nutrients are shown, as each kind of plant has a different potential for using these nutrients. Some

laboratories report soluble nutrients as low, medium, and high for phosphoric acid and potash. Reports may also be in terms of the elements, phosphorus and potassium rather than as phosphoric acid and potash. The National Soil and Fertilizer Research Committee has coordinated these ratings in pounds per acre as follows:

<i>Substance</i>	<i>Low</i>	<i>Medium</i>	<i>High</i>
Phosphoric acid (P ₂ O ₅).	0-100	100-150	Above 150.
Phosphorus (P)	0-44	44-65	Above 65.
Potash K ₂ O)	50-150	150-250	Above 250.
Potassium (K)	42-124	124-208	Above 208.

Several laboratories report on the basis of parts per million (ppm), which may be converted into pounds per acre by multiplying by two (for example, 40 ppm is 80 pounds per acre). Others report in terms of percentages, which may be converted into pounds by adding two decimal places and multiplying by two million (for example, 0.0025 percent is 0.000025, and this figure multiplied by 2,000,000 gives 50 pounds per acre).

5-4.2.3. Tests for magnesium and calcium. Deficiencies of both elements are very likely to occur on strongly acid soils and are generally corrected by application of dolomitic limestone for magnesium and of ground limestone for calcium.

5-4.2.4. Tests for iron. Deficiency of iron in soil may be detected by the yellowed (chlorotic) appearance of vegetation. Deficiency often occurs in sandy soils, soils that are highly calcareous (high in lime content) and soils lacking in organic matter.

5-4.2.5. Tests for alkalinity and acidity. Highly alkaline soils tend to lack structure-the soil particles merge, resist penetration of air and water, and prevent normal root development. Alkalinity and acidity of soil are expressed in terms of pH (the logarithm of the reciprocal of the hydrogen ion concentration) and are registered upward (alkaline) and downward (acid) on a numerical scale from pH 7, which indicates neutrality. (See fig 5-3).

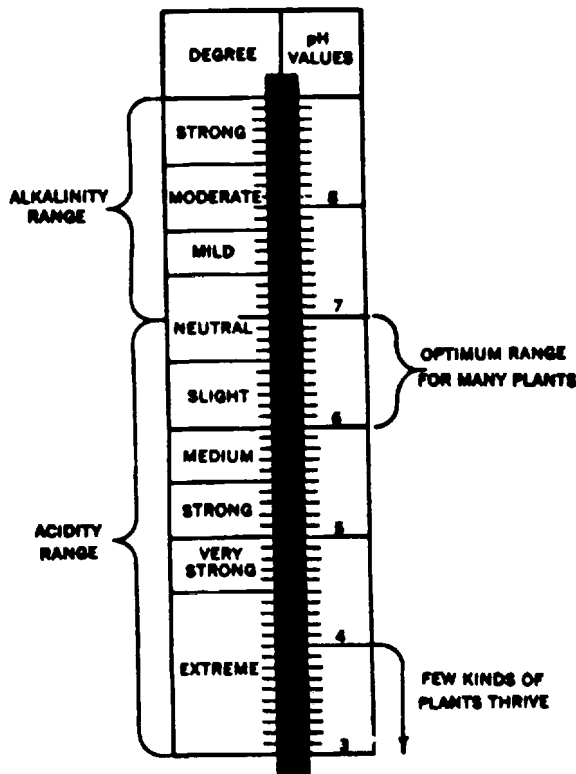

Figure 5-3. The pH scale.

5-4.2.6. Tests for toxic salts.

5-4.2.6.1. Soils that have a pH value greater than 8.5 may have objectionable amounts of alkaline salts. Incrustation of salt on a dry soil surface and failure of plants to respond to applications of fertilizer indicate the need for a laboratory test. Laboratory tests for salt are based upon the percentage of exchangeable sodium; more than 15 percent of the exchange complex occupied by sodium is harmful to most cultivated plants. Consult the Soil Salinity Laboratory Manual (U.S. Department of Agriculture Handbook No. 60) for detailed information on this subject. In arid sections, the salt content of water used for irrigation is also important. A laboratory test of water supplies may be necessary. Difficulty in the maintenance of plant growth may be expected if soluble salts in the water exceed 1,200 parts per million.

5-4.2.6.2. Installations having toxic salt problems, in establishing or maintaining vegetative cover, should consult the USDA Agricultural Extension Service at the county or state level. Information should include recommended treatments pertaining to soil cultural practices and advice on locally adapted plants that are tolerant to the toxic conditions.

5-4.2.7. Tests for organic matter. Tests for organic

matter in soil are made by laboratory methods and the findings are expressed in percentages of dry weight. Most well-drained soils contain 5 percent or less of organic matter. Southern and desert soils tend to have lower percentages than northern or temperate-zone soils, while peat may contain more than 50 percent of organic matter. The percentage of organic matter reported by soil laboratories should not be confused with "percent organic matter" commonly reported in the construction of golf courses, which may refer to volume rather than to dryweight.

5-5. Soil Surveys and Land Use Capabilities. Soil surveys provide for classifying, naming soil types and delineating each kind of soil. They include predictions of soil behavior under specific management. Soil surveys are made and published for designated areas such as counties, special projects, or soil conservation districts. The soils are mapped and classified without regard for existing or expected land ownership boundaries or present use. Each kind of soil has its peculiar set of characteristics and qualities which are described in terms that can be observed. These include soil texture; structure; drainage factor; depth; soil horizons; organic matter content; acidity and slope; all effecting soil management.

5-5.1. *Maps.* Aerial photo maps are used to record the location, area and slope of each soil. The mapping is done at different degrees of intensity depending upon the uses made of the soils information. The information is assembled and published as a soil survey report. The report includes a set of soil survey maps usually on a scale of four inches to the mile and a detailed description of each soil. Results from soil laboratory analysis aid interpretation.

5-5.2. *Soil Survey Interpretation.* A section of the report gives the soil scientist's interpretation of the information secured about each of the soils. Additional interpretations made by other specialists might also be included. Interpretive findings are most valuable in planning the use of land and its management. When man uses soil he commonly changes it drastically. The soil scientist's interpretations include adaptability to cultivated crops, grasses and trees as well as the safe effective systems of management. To further assist users of soil surveys, individual soil mapping units are grouped together into capability classes and subclasses. The capability classification is a practical grouping based

on limitations of soils, the risk of damage when they are used and the way they respond to treatment. The eight capability classes in the broadest grouping are designated by Roman numerals I through VIII. In class I are soils that have few limitations, the widest range of use, and the least risk of damage. The soils in the other classes have progressing greater natural limitations. Class VIII are those soils and land forms so rough, shallow or otherwise limited that they do not produce worthwhile yields of crops, forage or wood products.

5-5.3. Land Use Capability Interpretation. Land used within its capability is easily and economically maintained. Used beyond its capability it fails, requiring complete renovation. For example; some class II wet land can, after installation of a tile system, be used intensively for parade grounds or athletic fields while other wet land, in spite of tiling, will compact, puddle at the surface and severely retard infiltration of rainfall. Airfields built on soils with an impervious layer without adequate drainage become floating runways when the soil is completely saturated. Excessively drained soils, even in areas of high rainfall, will show drought damage to its vegetation unless organic matter is added, drought tolerant species planted, or irrigation provided. Land use capability classes and interpretations are very useful when preparing plans for improved grounds and agricultural outleased lands. A thorough understanding of soil capabilities and limitations are basic to sound land

use decisions and maintenance programs. Modern published soil surveys contain valuable qualitative information for engineers and earth moving contractors. The following engineering information is generally found in modern soil surveys:

5-5.3.1. General suitability for: Source of topsoil, sand and gravel; subgrade; and foundation material. *5-5.3.2. Soil-water relations:* Drainage class; seasonal high water table; erosion hazard and permeability.

5-5.3.3. Special Problems: Flood hazard, wind erosion, shallow bedrock, cemented or compacted layers, stability of slopes and seepage in cuts. Standard soil surveys such as those conducted by the Soil Conservation Service (S.C.S.) U.S. Department of Agriculture, in cooperation with the state agricultural experiment stations, when accompanied by appropriate interpretations can be adapted to meet the basic soils data needs of comprehensive planning at DOD installations. The S.C.S. maintains a complete list of all soil surveys which are completed and published as well as those which are still in the process of completion. Information on the availability of soil survey data may be obtained by writing to the State Soil Conservationist, Soil Conservation Service, in your state, or to the US Department of Agriculture, Soil Conservation Service, Soil Survey Publications Staff, Washington DC 20250.

CHAPTER 6. DRAINAGE

6-1. Importance and Factors of Drainage. Drainage is the flow of excess water from an area by external or internal routes to a specific discharge point. Drainage is also the process of draining and the means used to dispose of excess water. Good drainage is necessary for the prevention of storm damage, landslides and flooding, for maintenance of desired vegetation, for operational safety and efficiency, and for preventing breeding places which harbor disease-transmitting insects. Principal factors involved in drainage are soil permeability, grade, and vegetative covering. Vegetative covering helps increase the rate of infiltration, decreases the runoff rate, and reduces the drainage load on disposal facilities. Reduction of runoff rate is important in the control of soil erosion. Watershed areas which contribute to storm and flood runoff may be improved by proper use of vegetative cover, construction of terraces, diversion channels, debris basins, flood gates, and the like. Maintenance of storm drainage systems includes the removal of accumulated silt, gravel and other debris along the channel flow line and at drainage structures; and the control of willow, cattail and similar vegetation which inhibit channel flow. Redesign of existing channels and the construction of new channels may be required to accommodate increased runoff from new development areas (e.g., new buildings and surfaced areas). For drainage improvements on land where soil series can be identified, land managers should utilize soil survey information prepared by the Soil Conservation Service. (See para. 5-1 and 5-5.) This soil information provides guidelines on type of drainage (surface or subsurface) suitable for a particular soil and terrain situation.

6-2. Watershed Improvement. Any consideration of a drainage system immediately involves the watershed and its contribution to total storm runoff.

6-2.1. Objective. Watersheds can generally be improved by reducing the rate of runoff and increasing the rate of water infiltration into the soil.

6-2.2. Procedures for Watershed Improvement.

6-2.2.1. Soil conservation practices. If a watershed is unimproved grounds under military jurisdiction, use standard agricultural practices for soil conservation. Standard practices include: vegetating sparse or denuded areas to plants, including forest and wildlife

seedlings, adaptable to the soil capabilities; and constructing diversion terraces and outlet channels as appropriate. If the area is in an agricultural outlease program, specify rate of grazing and contour strip cropping where practicable. Standard practices also include fertilization and soil amendments as required.

6-2.2.2. Local cooperation. If a watershed is not under military jurisdiction, request local agencies to cooperate in introducing acceptable soil-conserving measures.

6-2.2.3. Forest lands. Where the watershed is forested and managed as such, apply practices prescribed for forests in the forest management plan.

6-2.2.4. Improved grounds. Where the watershed is improved grounds, use maximum permissible height of cut for mowed areas to decrease runoff. Vegetation cut at 3 inches will prevent rapid runoff more effectively than lower cuts. Develop effective vegetative cover by planting and fertilizing all denuded slopes, ball fields, and areas where troops concentrate. Control foot and vehicular traffic in built-up areas.

6-3. Drainage Systems. The two types of drainage systems are surface and subsurface. Classification depends on whether water is on or below ground surface when first collected for disposal. Both systems should be closely coordinated with requirements for health and sanitation.

6-3.1. Surface Drainage. Surface drainage provides for the collection and disposal of water from the surfaces of land as well as runoff from buildings, pavements, taxiways, runways, and hardstands. Surface facilities may include existing streams, open ditches, diversion channels, terraces, and levees.

6-3.2. Subsurface Drainage. Subsurface drainage provides for the collection and removal of excess water in the subgrade. This type of drainage is also used to prevent the water table from rising to a point where it affects the stability of surfaces adjoining runways, taxiways, and hardstands. Subsurface structures include

storm sewers, catch basins, manholes, outfalls, french drains, subsurface field drains, and so forth.

6-4. Design and Construction. Land managers at military installations are involved primarily in the maintenance of existing systems. When repair or alteration of existing systems is involved, or when new systems are required, the design and plans should be prepared by personnel trained in such work. See AFM 88-5, Chapter 4/NAVFAC DM-5/and TM 5-820-4, (app. A, no. 6). for information specific to surface and subsurface design, construction and installation.

6-5. Maintenance. Frequent inspections of the system are required to prevent costly repairs and breakdowns at key points. The following are examples of maintenance procedures required;

6-5.1. Maintenance of Terraces. Preventive maintenance includes periodic checking of all terraced areas and outlet channels, especially after heavy rains. Repair breaks in terraces by filling, fertilizing, and planting erosion-preventive vegetation. Construct additional terraces in areas that have been inadequately terraced. Repair structures, drainage outlets, and diversion ditches when necessary, and correct conditions that have caused the failures.

6-5.2. Field Tile Maintenance. Maintain a chart showing location of lines and outlets of installed tile. Use soil augers and probes to locate lines for which records are not available. Repair sections of those lines and outlets, which have failed, structurally or from corrosion, to prevent damage to other parts of the system. Indications

of failures are poor drainage after rains in some sections of the tiled area and cave-ins over the lines. Install flap covers at outlets to keep rodents out. Pay special attention to all outlets to assure that they are open and that adequate headwalls and manholes are constructed. Expose plugged lines and repair them; or, where necessary, replace by larger tile and correct the tile grade. Clean out tile lines filled with tree roots. If the trees and shrubs causing the difficulty cannot be killed or removed, replace the section with sewer tile installed with carefully mortared joints. Install relief wells in lines that tend to blow out because of higher pressure. Relief wells consist of a T-connection in the line with vertical sections of sewer pipe to the soil surface. Locate relief wells where they cannot be damaged by mowing equipment and will not interfere with athletic activities on ball fields. Protect well tops with gratings.

6-5.3. Channel Maintenance. Inspect channels after each storm. Repair and redesign overalls, chutes, drop inlets, and other structures as necessary. Provide new structures, as necessary, to carry the discharge. Enlarge channels at key points, especially where they pass under roads or railroads. Maintain channel and channel banks in vegetative cover where grades are not steep enough to require structures. Prevent woody vegetation, cattails, and similar tall growing water loving plants from becoming established. Grazing on open channel banks is permissible, except on sections that tend to erode. Avoid overgrazing.

CHAPTER 7. SOIL EROSION

7-1. Water Erosion Control. The primary object in the control of erosion is to retard all rainfall at the point of impact so that it either soaks into the soil or is directed to well protected waterways where it flows at nonerosive speeds. Prevention and correction of soil erosion is accomplished by improving the vegetative cover and installing supporting engineering measures including vegetated diversion terraces and outlet channels.

7-1.1. Vegetative Cover. Vegetation provides an effective control of erosion for most sites. Even in most deserts and on steep slopes, vegetation is used effectively where combined with other appropriate control methods. Maintenance of areas established to vegetation includes mowing and fertilizing where necessary to develop a dense turf; use of herbicides to eliminate brush and weeds that may destroy plantings; repair of bare areas that have lost their effective cover; and construction of flumes, terraces, retaining walls or other facilities where vegetation is found to be inadequate for resisting erosion caused by storm runoff.

7-1.2. Engineering Measures. Most of the factors used in the design of engineering measures are included in chapter 6, Drainage, since soil erosion control and storm runoff control on military installations are so closely allied. (See para. 7-5 for measures relating to pre-construction and construction operations. See also para. 15-12 for erosion control in drastically disturbed areas). Contact the U.S. Soil Conservation Service, local or state office, for recommendations on soil erosion control structures (e.g. diversion terraces and outlet channels).

7-2. Wind Erosion and Dust Control. Major wind erosion problem areas are the Great Plains, the Columbia River Plains, parts of the Pacific Southwest, the Colorado Basin, the muck and sandy areas in the Great Lakes region, and the sands of the Gulf and Atlantic seaboard. The fine silt and clay particles along with light weight organic materials are picked up and blown away in dust storms. The heavier sand particles do not become air born but bounce along the soil surface in a movement called "saltation". Soil blowing adversely affects the health, safety, and morale of personnel as well as damaging facility improvements and equipment. Housing areas, airfields, firing ranges, hangars, hospitals, athletic fields, lawns, and parking lots are all

subject to damage by blowing soil and drifting sand. Sand and dust damage to technical equipment, aircraft, flight instruments and other engines results in unnecessary maintenance costs, frequent replacement of engines and parts and an increase in accidents. Dust and sand passing through a jet engine cause loss of thrust and increased fuel consumption. Airfields with thin vegetation alongside of the runways add to dust damage with every plane that takes off. Preventive rather than corrective measures are called for, especially in areas where wind erosion is known to be common. Most active sources of dust are on the installation itself. If important sources are located outside the installation, coordinate and cooperate with adjacent land owners, community groups, and state and federal agencies concerned with soil conservation.

7-2.1. Control Measures. These must encompass all wind erosion and dust problems at the installation since partial measures can lead to loss of existing treatments and create additional problems. Timely inspections, strict foot and vehicular traffic control, and compliance with a scheduled vegetation maintenance program can substantially reduce wind erosion and dust problems. Where water supply for irrigation is limited, priority of water use should be given to potential dust producing areas such as athletic fields. Training should not be permitted on areas planted for wind erosion and dust control. Pedestrian, vehicle and aircraft traffic should be controlled to prevent formation of dust producing areas. Control measures include rough tilling, vegetating, mulching, treatment with chemicals or special oils, and erecting snow fence or other mechanical barriers. See tables 7-1 and 7-2 for some appropriate products and materials. Also, dust palliative methods and materials are discussed in TM 5-830-3/AFM 88-17, Chapter 3.

7-2.1.1. Mechanical measures.

7-2.1.1.1. Rough tillage. Rough tillage is an effective temporary means of dust control. Tillage operations should be performed at right angles to the prevailing winds. The resulting rough, cloddy conditions will provide

an obstacle to the force and speed of the wind and will retard the movement of surface water following periods of intense rainfall. Rough tillage may be especially helpful at construction projects prior to establishment of vegetation. Tillage by plowing or disking is accomplished over an entire area or at regularly spaced intervals.

7-2.1.1.2. Aggregates.

7-2.1.1.2.1. Materials. In areas where rainfall is so limited that vegetation is sparse, effective dust control can be achieved by use of gravel blankets. The material should be relatively free of sand or fines. In administrative and

industrial-type areas, rock or stone, one to two inches in diameter are capable of withstanding limited foot-traffic, but vehicular traffic should be prohibited. Gravel blankets should not be used on areas subjected to propeller blast since there is danger of blowing gravel into nearby aircraft. On these and other areas of high wind velocities, well-stabilized angular stone, two inches in diameter or larger may be used. Gravel or crushed stone is not used adjacent to runways or taxiways utilized by jet aircraft or on areas subjected to blast from jet aircraft.

Table 7-1. Organic Mulches^a

Name	Soil Stabilizer (SS) and/or Mulch (M)	Settled Depth in Inches	Description and Suitability	Application Rate and Method	Weed Control ^b	Resistance to Fire ^b
1. Bark	SS and M	3-4	<p>By-product of saw mills used as is or hogged (processed by specialized equipment to standard-size particles and sold in bulk by the cubic yard or packaged, usually in three-cubic-foot bags). Standards of the National Bark Producers Association are as follows:</p> <p>Category #1--Decorative Bark, 1/4" or larger in size with cambium and wood extraction applied. Used for walkways, under playground equipment, mulching, etc.</p> <p>Category #2--Soil Conditioner, 90% 1/4" or less in size. Mixed with soil to provide humus and nutrients.</p> <p>Category #3--Base Bark, not meeting requirements of Categories #1 and #2, has a maximum 10% wood fiber content and specifically includes pine cambium and shredded hardwood bark. Used for mulching to control soil erosion, weed growth, loss of moisture, extremes of soil temperature, etc. Is more wash resistant on slopes.</p> <p>Bark decomposes at medium rate.</p> <p>When bark is to serve both a decorative purpose and as a mulch around trees and shrubs, 2" -3" of Base Bark may be used with 1"-2" of Decorative Bark (nuggets) on top. Seedbed mulching should be shallower.</p>	If mixed with soil during seed bed preparation, approximately 25 lbs per acre of additional nitrogen is required.	F	F
2. By-products of Certain Crops	M	3-4	<p>Bagasse is a waste product from sugar cane industry. Unprocessed cane fibers have high moisture content, irregular size. Decomposes slowly and stays in place.</p>	Straw mulcher at rate of 1-2 tons per acre following application of	F	F
	M	2	<p>Buckwheat hulls decay fast, are easily blown, and attract rodents.</p>		P	P
	M	2	<p>Cocoa bean hulls, by-product of processing the cocoa bean, decompose fast, are easily blown, and attract rodents.</p>	P	P	
	M	3-4	<p>Coconut fiber, usually a mixture of long fibers and coarse granules, decays slowly and stays in place.</p>	F	F	
	M	2	<p>Cottonseed hulls decay at medium rate and are easily blown.</p>	F	P	

Table 7-1. Organic Mulches^a-Continued

Name	Soil Stabilizer SS) and/or Mulch (M)	Settled Depth in Inches	Description and Suitability	Application Rate and Method	Weed Control ^b	Resistance to Fire ^b
	M	2-3	Ground corn-cobs are excellent until decomposition starts, then must be stired occasionally; decay at medium rate and improve soil.		F	F
	M	2-3	Peanut hulls decay rapidly, stay in place, but are unattractive.		P	P
	M	3-4	Tobacco stems are relatively decay-resistant and stay in place.		F	F
3. Evergreen Boughs	M	Varies	Branches trimmed from surplus pines or expended Christmas tree J are excellent for protecting perennials and tender woody plants during the winter and early spring.	Apply in sufficient depth to cover ground and plants completely and only after ground has frozen to prevent heaving from alternate thawing and freezing.	P	P
4. Excelsior	SS	2	In blanket form, excelsior is used in the establishment of vegetation on critical areas such as drainage-ways. Conserves soil moisture, insulates against intense solar radiation, dissipates energy from falling raindrops, reduces erosion caused by runoff. Decomposes slowly and stays in place.	Secure with metal staples.	F	F
	M	2-3	Loose excelsior, cut into 8' lengths, can be applied with or without asphalt tack. Has been rated as good as straw tacked with asphalt and superior to short-fibered wood cellulose pulps for soil protection and plant establishment. Decomposes fast and is easily blown without sack.	With or without asphalt tack.	P	P
5. Grass Clippings	M	2	Cut grass is an excellent material for one season's duration but should be dried a while between cutting and mulching to prevent fermentation. Preserves moisture, keeps the soil cool, and discourages weed growth but should be stirred occasionally to prevent crustings. Often causes severe growth of fungus during decomposition.		F	F

Table 7-1. Organic Mulches^a-Continued

Name	Soil Stabilizer SS) and/or Mulch (M)	Settled Depth in Inches	Description and Suitability	Application Rate and Method	Weed Control ^b	Resistance to Fire ^b
6. Jute Netting	SS and M		Netting made of thick, fibrous strands of jute is useful on seeded drainageways. When fastened in place and tightly bonded to the soil surface, jute netting shields the soil from erosive action of rain splash and runoff and provides favorable environment for seed germination and plant development. (Other nettings of fiber glass, plastic, and paper yarn may be used to anchor straw, hay, wood chips, or grass and sod in drainageways and other areas subject to concentrated runoff.)	Fasten with metal staples to soil surface.	G	G
7. Leaf-mold	M	2	Leaf-mold is partially decomposed debris on ground of deciduous forest. Is excellent source of humus but not very long-lasting. Does not deter weed growth.		P	G
8. Leaves	M	2-3	Oak and beech leaves are excellent as they decay slowly and do not mat; however, they may be wind-blown and are a fire hazard at first. May cause severe growth of fungus during decomposition. (Maple and elm leaves decay quickly and form a gelatinous layer over the soil surface which is impermeable to air and water. <i>Not suitable for mulching</i>)	Apply annually up to one foot in depth, especially under broad-leaved evergreens.	F	P
9. Manure	SS and M	2-3	Manure is valuable as mulch and as a source of plant nutrients. Tests conducted in Ohio have shown that on 10-12% slope, soil loss on areas with manure measured 0.5 tons per acre compared to 12.5 tons per acre on unmulched areas. Decomposes fast and improves soil.	8-10 tons per acre.	P	G
10. Paper	SS		Macerated paper, produced by passing newspaper through a hammermill, gave satisfactory results in tests in Utah but was not as long-lasting as wood fiber or straw tacked with asphalt. Treated with asphalt, while not -2 permeable to air and water, will control weeds and is satisfactory under certain conditions. Decomposes fast and stays in place.	Slurry, at approximately 1,500 lbs per acre.	F	F

Table 7-1. Organic Mulches^a-Continued

Name	Soil Stabilizer SS) and/or Mulch (M)	Settled Depth in Inches	Description and Suitability	Application Rate and Method	Weed Control ^b	Resistance to Fire ^b
11. Pine Needles	M	2-3	Where pines re abundant, the needles may be used to form an attractive, long-lasting mulch, but with the disadvantage of being a fire hazard. Stays in place.	Apply annually at rate of 6 to 12 inches. especially under borad-leaved evergreens.	F	F
12. Sawdust	SS and M	2 min.	Sawdust, a by-product of lumber industry, is subject to wind erosion and has a tendency to wash on steep slopes. Finder grades decay faster than coarser ones. Partially decomposed is preferred to fresh material. Advantages must be weighed against cost of application and renewal and the necessity of adding, during the first year, 25-50 lbs of available nitrogen fertilizer for each 1.1 ton sawdust and, during the second year, at about one-half the original rate. Old sawdust decomposes at medium rate and is easily moved.	Spread at rate of 275 to 810 cu yds per acre.	F	F
13. Sphagnum Peat	M	2-3	Developed from sphagnum bogs, peat is an acid, relatively long-fibered product which decomposes at a medium rate. Unless mixed with soil it forms a crust that makes it impermeable to air and water, or it may be windblown and a fire hazard. Adds humus. (Sedge peat is alkaline in nature, in a late state of decomposition and has little value as mulching material.)	F	P	
14. Straw/hay			Straw/hay is one of the most commonly used and best soil stabilizing and mulching materials. Conserves soil moisture, dissipates energy from falling raindrops, insulates from intense solar radiation, and reduces erosion caused by overland sheet flow. Windblown unless anchored, but decomposes fast and improves soil.	By hand or with mulch-blower that shreds, cuts, and evenly scatters. Anchor with specially designed crimper or a farm disc pulled along the ground contour.		
	SS and M	3	Straw alone, straw plus asphalt, and netting over straw have rated better in tests than manufactured mulches, retaining more soil moisutre for grass establishment. major problem.	Anchor with asphalt or chemical binders, or netting where wind is not a	F	P

Table 7-1. Organic Mulches^a-Continued

Name	Soil Stabilizer SS) and/or Mulch (M)	Settled Depth in Inches	Description and Suitability	Application Rate and Method	Weed Control ^b	Resistance to Fire ^b
	SS and M	2-3	Hay cut from mature grasses is excellent during the first season but must be stirred occasionally to allow penetration of air and rainfall when it starts to decompose.	Apply at rate about 2 tons per acre.	F	P
	SS and M	2	Salt hay from marshes near the seashore is more resistant to decay and considered quite desirable.	G	F	
	SS and M	6	Legume hay, cut from mature soy beans, sweet clover, and similar legumes, is of much looser structure than grass and is an excellent winter mulch but unattractive for all-season purposes.	P	P	
15. Wood(Brush) Chips	SS and M	2	Wood chips are waste material resulting from tree branches, shrubs, and brush being processed through a wood chipper during pruning or clearing operations and aged. Decompose slowly, stay in place. Excellent for erosion control on sandy soils but subject to termites in the south.	Spread with modified straw mulcher, after seed and fertilizer have been applied, at rate of 30 cu yds per acre. If mixed with soil, then additional nitrogen (50-70 lbs per acre) is required.		
16. Wood Fiber	M		Wood fiber is a fine-textured, short-fiber wood product, produced from wood chips. Designed for use with hydromulcher, it is best on steep slopes where conventional seeding and mulching practices cannot be used. Decomposes at medium rate and stays in place. (For additional information see subparagraph 1-3.1.)	In hydromulcher slurries, apply with seed, lime, and fertilizer at rate of 1,500-3,00 lbs per acre. If wood cellulose fiber is used as a tackifier for straw mulch, apply at rate of 750-1,500 lbs per acre.	F	G
17. Wood Shavings	M	2-3	Wood shavings are thinner and lighter than wood chips and not as attractive in appearance. May blow in the wind and decay more quickly than wood chips.	P	P	

^aOrganic mulches described in this table are not necessarily desirable for establishment of grass and/or legume seedlings. Density of the settled mulch, as it affects movement of air and water and the emergence of young seedlings, must be considered whenever it is used for seedling establishment. Other factors to be weighed in the choice of a mulch are comparative delivered cost, lasting quality, and storage requirements.

^bWeed control varies with the settled depth in inches. Resistance to fire depends on lasting moisture content.

G= Good

F= Fair

P= Poor

Table 7-2. Inorganic Mulches

Name	Soil Stabilizer (SS) and/or Mulch (M)	Settled Depth in Inches	Description and Suitability	Application Rate and Method	Weed Control ^b	Resistance to Fire ^b
1. Aluminum Foil	M	1	Reflects heat and keeps soil cool. Preserves moisture and prevents weeds. small holes for penetration of air and water and weighted down around edges.	Must be punctured with frequent	G	F
2. Fiberglass	SS and M	1	Flexible material which will not rot, corrode, or burn. Used in mat or blanket form, provides long-term resistance to erosive forces when stapled tightly to ground in drainageways and other critical areas. Benefits plant growth when applied in thin layer. When sprayed with compressed air, long strands form a dense, stable mat that provides long-term protection and more suitable environment for plant growth. Fibers are retained in rootmat of the developing vegetative cover, providing lasting reinforcement, in places where continual observation and care is difficult to maintain.	Mat or blanket form, or spray long strands of fiber with compressed air.	G	G
3. Gravel (Crushed Stone)	SS and M	1	Can be used alone or in combination with vegetation to provide permanent surface protection. Stones 1/2" or greater in size will suitably protect against rain splash and sheet flow and can withstand wind velocities up to 85 mph. A disadvantage is movability and possible hazard if thrown. Related materials are:	Apply to depth of 2-3 inches.	F	G
		1	Arcillite, 1-1/2" chunks of calcined montmorillonite clay with pleasing color and per-		G	G

Table 7-2. Inorganic Mulches-Continued

Name	Soil Stabilizer (SS) and/or Mulch (M)	Settled Depth in Inches	Description and Suitability	Application Rate and Method	Weed Control ^b	Resistance to Fire ^b
		1	meable to air and water. Shatter on impact, therefore causing fewer injuries if thrown.		F	G
		1	Pea gravel, a screened, natural rock gravel smaller in size than crushed rock but otherwise similar.		F	G
		1	Crushed tile, from ceramic industry, may be available in several colors and is on a par with arcillite.		F	G
4. Sand	M	1	A fine-grained material, which has poor stability and is easily moved by water.	1 inch	G	G
5. Plastics	SS and M	1	Chief material is opaque polyethylene. Transparent is not satisfactory, as the high temperature engendered by sunlight beneath the plastic is very harmful to plant roots. Both black and dark green are satisfactory, and white appears to be promising. The materials allow air and water interchange but prevent evaporation of soil moisture. Cost is low, and labor of installation not great. Usually must be renewed each season. Some users place a 1 layer of sand underneath to prevent it from tearing when stepped upon.	Must be punctured with frequent small holes for penetration of air and water and weighted down around edges.	G	P
	SS and M	1	Porous fabric woven from polypropylene monofilament yarns is lightweight, strong, abrasion-resistant, and unaffected by salt water. Used as replacement for graded sand filters beneath rip-rap and concrete structures placed in waterways. Prevents foundation soil particles from being drawn up through the structure by the hydraulic forces associated with concentrated and often turbulent runoff.		G	G

^aG = Good
F = Fair
P = Poor

7-2.1.1.2.2. *Placement.* Gravel blankets should have a minimum depth of two inches and should be at least as deep as the largest diameter of material specified.

7-2.1.1.2.3. *Disadvantages.* Use of gravel blankets has two main disadvantages: blankets are easily covered and rendered useless by sand and dust blown in from adjacent areas, and they trend to attract unauthorized vehicular traffic. Traffic soon breaks through the gravel layer and destroys its effectiveness.

7-2.1.1.3. *Asphaltic oil.* These treatments are of two general types: those producing a surface crust and those not producing a crust. Both are frequently termed oil palliatives. The crusting type is used on nontraffic areas, whereas the noncrusting type is used on athletic fields and grounds where hard surfaces are undesirable. Oil palliative treatments should be used for temporary control until suitable vegetative cover is established.

7-2.1.1.3.1. *Crusting.* Asphaltic oils of the slow curing (SC) type provide deeper soil penetration than the medium curing (MC) or rapid curing (RC) types and are preferred if available. Areas to be treated should be bladed to level the surface and watered lightly if the soil is dry. Then, the asphaltic oil should be applied with a distributor. The amount applied should not exceed that readily absorbed by the soil, usually not more than one-half gallon per square yard. The treatment is most effective when accomplished in warm weather. Since treated areas are black in color and resemble asphalt pavements, it is difficult to exclude vehicular traffic which greatly shortens the life of the treatment. Even when all traffic is excluded, the effective life of such a palliative rarely exceeds two years. Thus, it should be used only where satisfactory dust control cannot be established by other methods.

7-2.1.1.3.2. *Noncrusting.* The noncrusting oils are used primarily on playgrounds, physical training areas, and parking lots. This type of treatment is very effective in reducing respiratory disorders in areas where dust is a major hazard. Noncrusting oils have a relatively short life, and areas must be retreated every six to nine months to maintain satisfactory dust control. While these oils provide immediate control, their use should be limited to areas where turf cannot be established and maintained. If the surface is dry, water should be applied to promote penetration of the soil. The oil should be applied while the surface is still moist, with an average treatment of one-quarter gallon per square yard for most soils.

7-2.1.1.4. *Chemical.* Chemical treatments, in general, have limited and temporary usefulness as grounds treatments on installations.

7-2.1.1.4.1. *Calcium chloride.* This chemical is used for control of dust on unpaved roadways (TM 5-624/NAVFAC MO-102/AFR 85-8, app. A, no. 7) not recommended for use on sites within the scope of this publication.

7-2.1.1.4.2. *Soil conditioners.* Chemical soil conditioners may be used to bind particles of surface soil together to make them more resistant to erosion. One chemical used for this purpose is synthetic resin. It is applied to the soil at the rate of approximately one pound per 100 square feet. It is sprinkled over the soil much as salt is sprinkled on food. Some of these resins form tight surface seals impervious to water; others form surface seals readily permeated by water. The resins forming permeable surfaces are preferred if vegetation is to be established. Resins are used simply as temporary conditioners, holding the soil in place until vegetation can be developed. Resins have not proved as economical or satisfactory as straw mulches. For this reason, their use is generally limited to areas in which straw would create a fire hazard or where, for reasons of convenience or appearance, the resin may be preferred.

7-2.1.1.4.3. *Wood lignin.* This is a liquid by-product of wood pulp manufacture. It is used for grounds treatment in much the same manner as liquid asphalt. It is subject to the same limitations as asphalt.

7-3. Shoreline Stabilization. Wind, wave and water forces keep shorelines in constant motion. Occasionally these natural processes pose a threat to the environment or to property, which requires mitigating action. The most economically and environmentally viable approach to shoreline stabilization is to let nature take its course unless the physical changes occurring in the coastal area pose a direct threat to DOD activities or important natural resources. Only in that event should shoreline stabilization measures be undertaken.

7-3.1. Nonstructural Shoreline Stabilization Techniques.

7-3.1.1. Installation should be ever vigilant for opportunities to employ nonstructural shoreline stabilization techniques. Nonstructural alternatives that may be available include: land use planning to physically separate DOD activities and real property improvements from the fragile shoreline area; dune and shore vegetation programs to stabilize and protect land forms;

dune and beach nourishment (activities which provide additional sand or other shore material to an eroded area); and construction of wind fences to reduce wind erosion.

7-3.1.2. Coastwise currents take sand from rivers where they enter the ocean and from eroding headlands and deposit it on the beaches. At low tide the surface layer of sand dries quickly, is caught by the wind and carried inland. Beach grass and other plants capable of withstanding sand blast and deposit, grow down the beach to the normal storm tide line, where they are halted by wave action. Those plants slow down surface wind, and sand is deposited in the vegetation. The vegetation continues to grow up through the sand causing more deposits.

This builds a sand ridge parallel to the coast line called a foredune. The lands in back of the foredune are then protected, which permits a dense sod, shrub or forest cover to develop. See Engineer Manual No. 1110-2-5003, app. A, no. 8, for dune creation and stabilization in the Coastal zone.

7-3.2. *Structural Shoreline Stabilization Techniques.* These should only be used to supplement a basic nonstructural shoreline control program; and when continued shore processes threaten valuable natural resources, or DOD real property improvements. Structural measures include but are not limited to: toe protection of bluff areas, slope or channel modification, berms, riprap, seawalls, gabions, bulkheads, breakwaters and groins. Selection and design of appropriate structural shoreline stabilization measures is a job for experts such as the Corps of Engineers Civil Works District. Shoreline protection plans will be coordinated with the requirements of State Coastal Zone Management Programs (Public Law 92-583, Coastal Zone Management Act, as amended).

7-4. Sand Dune Control.

7-4.1. *Coastal Dunes.* Projects involving protection of important structures and facilities from coastal storms on Army installations should be forwarded to the U.S. Army Coastal Engineer Research Center, Kingman Building, Fort Belvoir, VA, 22060, for technical review and advice. The U.S. Department of Agriculture, Soil Conservation Service, should be requested to provide technical guidance in plant selection, planting and fertilizing recommendations, and structural support such as stalling fences. That agency has considerable experience in sand dune stabilization. Typical coastal dunes are

located on the shores of the Pacific Ocean to Oregon and California, the Atlantic Ocean from Massachusetts to North Carolina, and the Great Lakes. Sand cannot be stabilized near the shores of large bodies of water with vegetation since storms keep these strips of beach sand active by wave action. Low dunes (called "foredunes") normally form near the shore line. These dunes may be kept from spreading to areas not subject to waves and spray by means of snow fences, picket fences, brush fences, or similar mechanical barriers. Such fences can be expected to be destroyed or covered during severe storms and will require repair or replacement. Sandy areas, including dunes that are located to the rear of the sandy shore may be mulched. Planted mulches may be substituted for applied mulches where winds are not severe. Plant adapted grasses, trees, or shrubs on these areas after mulching to assure permanent control. Atlantic and Great Lakes dunes may be established to American beach grass (*Ammophila brevigulata*) and Pacific dunes may be established to European beach grass (*Ammophila arenaria*). Both species must be established vegetatively by means of rooted plants. American beach grass* is available from native stands. European beach grass* is available from plant nurseries. Plant the clones on 18 inch spacings at a depth of 12 inches. Each clone should have about 5 culms. Mechanical planters may be used for larger projects. Replanting is necessary for repair after severe storms. Local native grasses, trees, and shrubs may be used in areas back of foredunes. Shrubs, where adapted, are especially useful. Scotch broom (*Cytisus scoparius*) is used in Pacific coast plantings, waxmyrtle (*Myrica cerifera*) is used in New Jersey to Florida, Scotch pine (*Pinus sylvestris*) is used from western North Carolina to Quebec and across the Lake States, and Jack pine (*Pinus banksiana*) near Great Lakes. Fertilizer is normally required to support plantings of either grass or woody plants on dune sand. Use magnesium ammonium phosphate (7-40-6) at the rate of 60 pounds plus 65 pounds of muriate of potash per acre. Subsequent treatments are made when required to prevent loss of the planting.

7-4.2. *Interior Dunes.* Many of the larger streams in the western half of Continental United States have dunes bordering the valleys. Extensive bodies of dune sand also occur in Texas, New Mexico, Colorado, and Nebraska. Most of these have a semi-arid climate and

*Some commercial distributors are listed in EM 1110-2 5003, app A, 8.

do not support dense vegetative cover. A careful study of local native plants is necessary. Protect the site to be stabilized from sand originating off the site by snow fence or other barriers. Mulch all areas to be controlled. Repeated repair of mulched surfaces is essential after each storm. The following species of grasses are suggested for use: Southwest Texas and Southeast New Mexico: Spike dropseed (*Sporobolus contractus*). Seed must be collected locally by hand. Commercial supplies are not available. Various shrubs such as salt cedar (*Tamarix species*) and desert willow (*Chilopsis linearis*) are useful on the more favorable sites. Northwest Texas, Western Oklahoma, Colorado and Northern New Mexico: Sand dropseed (*Sporobolus cryptandrus*), sand lovegrass (*Eragrostis trichodes*), blue gramagrass (*Bouteloua gracilis*), and sand bluestem (*Andropogon hallii*). Nebraska and Kansas: Sand reedgrass (*Calamovilfa longifolia*) sand bluestem (*Andropogon hallii*) planted vegetatively, blue gramagrass (*Bouteloua gracilis*) and sand dropseed (*Sporobolus cryptandrus*) planted with seed normally available commercially. Shrubs and trees may be used on sites where moisture is available. Sand plum (*Prunus angustifolia*), ponderosa pine (*Pinus ponderosa*), jack pine (*P. banksiana*), cottonwood (*Populus*) species, and common hackberry (*Celtis occidentalis*) are examples. Fertilize planted areas with 60 pounds of magnesium ammonium phosphate plus 65 pounds of muriate of potash per acre at planting time. Repeat fertilizer treatments when required to prevent loss of planting.

7-5. Environmental Protection During Pre-Construction and Construction Actions.

7-5.1. Pre-construction Actions.

7-5.1.1. General.

7-5.1.1.1. Definition. Preservation and restoration of the environment should be included in all plans, specifications, and estimates before a project is approved and/or undertaken. With the enactment of the National Environmental Policy Act of 1969 (1 January 1970, Pub. L. 91-190, 83 Stat. 852), many proposed projects will require Environmental Assessments (EA) and, perhaps, Environmental Impact Statements (EIS) which describe to what extent and by what means preservation and restoration of a project will be accomplished. The environmental issues raised therein should identify problems which must be dealt with throughout the planning process.

7-5.1.1.2, *Pre-planning action.* Pre-planning calls for a thorough review of the site conditions and potential impacts of each project. The EA, if prepared, should contain sufficient information to determine whether the

ongoing or proposed action is major and will have such significant impact on the quality of the environment that an EIS will be required. If required, the EIS should be prepared in accordance with AR 200-1/AFR 19-2/OPNAV Instruction 6240.3E/MCO P11000 8 (app. A, no. 1).

7-5.1.1.2.1. *Professional cooperation.* A real planning effort requires the cooperation of all professions: engineering, architecture, landscape architecture, forestry, agronomy, biology, ichthyology, etc., to obtain optimum results. With data provided by the various professionals and active consultation among them, the siting of facilities with regard to environmental impact on an area can be improved. For instance, a simpler grouping of structures to take advantage of natural screens by topography or tree masses can benefit the appearance of a project. Where existing topography is so flat that it cannot be used for screening, the siting of structures can be improved by creating earth berms and tree masses.

7-5.1.1.2.2. *Site impact studies.* Potential damage which might occur during construction should be identified in advance so that measures can be taken to minimize scars on the environment. For example, the proper selection of borrow areas and careful location of roads (both temporary and permanent) and construction support areas can prevent or reduce possible damage to vegetation and topography. In the process of clearing a site for construction, it is important that the supervising personnel be well informed on conservation policies in order to reduce or prevent excessive damage to trees and other natural features which cannot be replaced. In some instances, temporary physical barriers to protect such trees and natural features may be necessary.

7-5.1.1.2.3. *Protection of natural areas.* Recommendations should be made to determine feasible and necessary actions for preservation or rehabilitation of the natural resources (e.g., water bodies, flora, fauna, soils, and topography) within a project.

7-5.1.1.2.4. *Protection of special sites.* Recommendations should be made to determine feasible and necessary actions for preservation and rehabilitation of all sites, structures, and objects of historical, archeological, or cultural significance located on a

project in accordance with the Antiquities Act of 1906 (Pub. L. 209, 34 Stat. 225), the National Historic Preservation Act of 1966 (October 1966, Pub. L. 89-665, 80 Stat. 915), the National Environmental Policy Act of 1969, "Protection and Enhancement of the Cultural Environment", (E. O. 11593, 13 May 1971), the Archeological and Historic Preservation Act of 1974 (24 May 1974, Pub. L. 93-291, 88 Stat. 174), and the Archeological Resources Protection Act of 1979 (PL 96-95, 31 Oct. 1979).

7-5.1.1.2.5. Protection of threatened and endangered species. Recommendations should be made to determine feasible and necessary actions for preservation of threatened and endangered species of plants and animals and their habitats which may be in or affected by a project in accordance with the Endangered Species Act of 1973 (28 December 1973, Pub. L. 93-205, 87 Stat. 884) and other applicable Federal and State laws and executive orders listing such species.

7-5.1.2. Identification of nonliving components of a site. The initial goal of the preconstruction planning process is to identify the various environmental components of a site: namely, water in its various forms, light, atmospheric conditions, wind, topography, soils, subsurface conditions, and historical features.

7-5.1.2.1. Water. Water, whether a stream, river, pond, or rain, has an environmental effect upon a site. Plans and methods should be developed for the physical control and preservation of water on a site through the use of conservation practices, channel improvements, installation of structures for water retardation and sediment detention, and promotion of temporary and permanent vegetation to control runoff.

7-5.1.2.2. Light. Plans should take into account the effect of natural light upon the development of vegetation on a site. Lists of tree and shrub species which thrive under varying intensities of light (i.e., full sun, partial shade, and deep shade) should be formulated in order to obtain optimum growth results.

7-5.1.2.3. Atmospheric conditions. All atmospheric and meteorological influences (principally temperature, moisture, air pressure, and evaporation) should be ascertained. Various conditions will affect the character of a region by influencing its land forms, soils, vegetation, and land use. For example, precipitation that falls in the form of snow does not create runoff, but snow melting in spring can create a serious erosion hazard.

7-5.1.2.4. Wind. The effect of wind upon a site should be determined. Wind erosion occurs frequently on haul

roads and open construction sites and deposits soil on off-site areas and, to some extent, into waterways. Furthermore, dust is hazardous to human health.

7-5.1.2.5. Topography. The configuration of the land surface should be studied in order to take advantage of the natural features of an area. Topography should influence the location of structures, roads, parking areas, sound barriers, storage and service yards, and plantings.

7-5.1.2.6. Soils. Soils should be analyzed in order to make recommendations for erosion control during construction and soil improvement following construction activities. Storm runoff and erosion vary from site to site, depending upon the characteristics of a particular soil. The erodability and stability of a soil depend on its structure, texture, organic matter content, moisture content, permeability, and degree of slope. Such information should be available from the installation Soil Survey Report or from the county soil survey developed by the Soil Conservation Service (app. D, no. 1).

7-5.1.2.7. Subsurface conditions. On each project site, the subsurface conditions should be investigated to determine the depth of various soil strata (i.e., the soil profile), underlying rock characteristics, internal drainage, and groundwater table. Subsurface formations affect the stability of a site and impact of its development.

7-5.1.2.8. Historical features. Necessary action should be taken to preserve, restore, or rehabilitate all structures and objects on a project site which have been certified under the National Historic Preservation Act of 1966 as having sufficient historical significance. Consideration should also be given to include those structures and objects which may have potential for listing in the National Register but have not yet been so listed.

7-5.1.3. Identification of living components of a site. Necessary action should be taken to preserve threatened or endangered plant and animal life found on a project site. This includes a plant and wildlife inventory and a description of the effects the proposed project will have upon these populations and the critical habitats of threatened and endangered species. The preservation of specimen trees or shrubs may be accomplished by proper grading and drainage practices, constructing tree wells/walls, or if practical transplanting to another site.

The Fish and Wildlife Service (app. D, no. 2) must be contacted regarding any proposed relocation of threatened species.

7-5.1.4. Determination of project effects upon nonliving and living components of a site. It should be determined whether modification of a site will result in a terminal, permissible, or compatible situation:

7-5.1.4.1. Terminal. Total loss of existing plant and animal life in the area of the project.

7-5.1.4.2. Permissible. Temporary loss of habitat until mitigation efforts are implemented.

7-5.1.4.3. Compatible. An improved habitat for plants and animals or one which does not seriously damage the existing habitat.

7-5.1.5. Minimization of potential damage. There are several measures which may be taken to minimize erosion damage to a site and downstream areas. Design criteria for all types of erosion control structures can be found in Erosion and Sediment Control: Surface Mining in the Eastern U.S. (app. E, no. 8) and Specifications for Soil Erosion and Sediment Control in Developing Areas (app. E, no. 8) and Engineering Field Manual for Conservation Practices (app. E, no. 8).

7-5.1.5.1. Barricades. Various types of traps or barriers may be used to control erosion, including sandbags, straw bales, stone check dams, log and pole structures, and sediment traps.

7-5.1.5.1. Sandbags and Straw bales. A sandbag barrier is constructed of bags filled with sand or crushed rock and stacked in an interlocking manner. Straw bale barriers are constructed of stacked bales of hay or straw. The bales should be tied with wire and staked to the ground for added stability. They should also be set four to six inches into the ground with excavated soil material compacted along the uphill side to prevent undercutting.

7-5.1.5.1.2. Log-and-pole structures. Log-and-pole structures are temporary control measures which should be used only if adequate material and labor are available. They serve two purposes: to retard runoff and catch some sediment. End to delay and reduce the peak flow.

7-5.1.5.1.3. Stone check dams. Stone check dams are constructed across drainage channels by placing wood baffles approximately two feet apart and filling the space between the baffles with stone. The downstream face of the dam should be riprapped with stone.

7-5.1.5.1.4. Sediment traps. Such pits are small, temporary excavations used in appropriate areas to detain runoff for a short period of time and to trap heavier sediment particles.

7-5.1.5.2. Berms. A berm is a ridge of compacted soil placed above, below, or around a disturbed area to intercept runoff and divert it to a safe disposal area. Berms may also be used to screen unsightly areas or to give added height to trees for more effective screening of tall structures.

7-5.1.5.3. Drainage diversions. Drainage diversions also intercept runoff and direct it to a safe disposal area. Interception and diversion are accomplished by using various structures such as reverse benches or terraces, ditches, earth dikes, and combinations of ditch and dike.

7-5.1.5.4. Sediment basins. Sediment or silting basins should be installed at the beginning of grading operations to minimize potential damage (fig. 7-1). Both temporary and permanent basins should be designed to accommodate the runoff of a local 2-year storm. Overflow should be handled by paved weir or vertical overflow pipe, draining from the surface. The collected sediment should be returned to the source of the erosion or used as fill on the construction site or other sites, as appropriate.

7-5.1.5.5. Topsoil salvage. As much suitable soil material (determined from the soil survey) as possible should be salvaged from all areas disturbed by construction. This material should be stockpiled on the site in an area which has been carefully selected in relation to both additional construction and site restoration at the conclusion of the project.



Figure 7-1. Sediment basin on a construction site.

7-5.1.5.6. *Mulches.* The most common materials used for mulching purposes are straw, hay, wood chips, and wood fiber. These materials promote the establishment of vegetative ground cover and protect the seedbed from excessive erosion until new vegetation is established. Straw and hay may require an application of asphalt emulsion or chemical tackifier, or mechanical anchoring to prevent removal by wind and water. Inorganic materials can also be used for mulching purposes. Nettings of fiberglass, plastic, and jute can be used to anchor straw, hay, wood chips, or grass in drainage ways and other areas subject to concentrated runoff. Flexible fiberglass is probably the most widely used for long-term protection since it will not rot, corrode, or burn. It may be used in mat or blanket form or applied by spraying a thin

layer, resulting in a dense, stable mat that provides a more suitable environment for plant growth. Plastic filter sheets consist of a porous fabric woven from polypropylene monofilament yarns. They are used to prevent erosion beneath riprap and concrete structures. For additional information on mulches, see paragraph 15-5.16.

7-5.1.5. *Existing vegetation.* All types of vegetation existing on a site should be identified, and recommendations should be made for species and specimens to be saved. The following steps should be taken to preserve vegetation.

7-5.1.5.7.1. Determine those areas where construction

is to take place and where it will be impossible to preserve any vegetation.

7-5.1.5. 7.2. Determine those areas which are in close proximity to construction areas and provide some type of barricade to protect them from construction equipment.

7-5.1.5. 7.3. Within these marginal areas, select those trees and shrubs which have exceptionally fine shape and form and protect them with additional fencing or barricades.

7-5.1.5.7.4. Move any exceptionally fine specimen trees and shrubs which cannot be retained within the construction area to an appropriate holding or nursery area for possible use in the permanent landscaping of the site. Limitations with regard to size, soil conditions, and climate will dictate how large a tree or shrub can be safely moved and transplanted.

7-5.1.5.7.5. Provide a maintenance plan for all vegetation which has been moved to a new location. Without such a plan, it will be a waste of time and money to transplant existing vegetation.

7-5.2. *Construction Actions.*

7-5.2.1. *Control of construction area*

7-5.2.1.1. *Proper Planning.* It is necessary to approach any given problem from a team standpoint where the design engineer, landscape architect, architect, planner, and construction engineer work together in planning the project and developing design, construction, and maintenance techniques, all with regard to the preservation and restoration of the environment. Five basic principles should govern the planning and design of the project:

7-5.2.1.1.1. Plan the project to fit the topography, soils, waterways, and natural vegetation on the site.

7-5.2.1.1.2. Expose the smallest practicable area of land for the shortest possible time.

7-5.2.1.1.3. Apply soil erosion control practices as a first line of defense against off-site damage.

7-5.2.1.1.4. Apply sediment control practices as a second line of defense against off-site damage.

7-5.2.1.1.5. Implement a thorough maintenance program before, during, and after operations are completed.

7-5.2.1.2. Support areas. Support areas encompass all areas of a project occupied by material and equipment storage yards, office and construction buildings, mixing plants, and repair shops. Such areas vary in size, depending upon the size of a project. Where a construction support area is under intensive use, all vegetation within the area will probably either be destroyed or suffer extensive damage. Even vegetated

areas adjacent to the construction site may suffer extensive damage due to dust, smoke, fumes, and sprays. Every effort should be made to control these irritants. Dust may be controlled through sprinkling, chemical treatment, light bituminous treatment, or mulching with wood chips, wood fiber, or plastics. Smoke, fumes, and sprays should be controlled by strict adherence to the air emissions standards promulgated under Federal and State Clean Air Acts. Erosion in the construction area should be controlled through proper grading, diversion ditches, drainage control, settling basins, and vegetation.

7-5.2.1.3. *Access during construction.* All construction sites require access. Often, access roads and railroads are temporary and will be obliterated at the completion of a project. If at all possible, it is both economically and environmentally sound to plan and design access routes in their permanent locations. If project access' routes connect with public roads, it is necessary to ensure public safety. This may require acceleration and deceleration lanes on public roads, traffic lights, and signs, as determined by highway authorities.

7-5.2.1.4. *Drainage control.* Surface drainage from the construction area and from borrow and waste disposal areas should be held in suitable sedimentation ponds, or the areas should be graded to control erosion within acceptable limits. Temporary erosion and sediment control measures, such as berms, dikes, drains, or sediment basins, should be provided and maintained until permanent drainage and erosion control facilities are completed and operative. As previously stated, the area of bare soil exposed at any one time by construction operations should be held to a minimum. Any stream crossings encountered in a project area should be covered by temporary culverts or bridge structures. Erosion on cut and fill slopes may be controlled through planting and mulching processes.

7-5.2.1.5. *Dust control.* Dust should be kept down at all times, including nonworking hours, weekends, and holidays. Soil on the site, haul roads, and other areas disturbed by construction operations should be sprinkled or treated with dust suppressors as necessary to control dust. Temporary storm fences should be used to help protect sensitive areas. In lieu of dry-power brooming, which should not be permitted, use vacuuming, wet mopping, wet sweeping, or wet-power brooming.

7-5.2.1.6. *Fences and barricades.* Heavy equipment destroys vegetation and compacts soil to a point where air and water cannot adequately penetrate the surface and reach the roots. To prevent damage by construction equipment, all areas and vegetation to be preserved should be fenced or barricaded, and compaction of the soil around roots should be avoided. Appropriate warning signs should be attached to the fence at minimum intervals of 20 feet along the perimeter. Specimen trees and shrubs to be preserved, and not within a barricaded area, will require sufficiently large steel or wood posts, spaced close enough together around the tree or shrub to protect against heavy equipment.

7-5.2.1.7. *Screens.* Screening objectionable portions of a project can be accomplished through the planned use of spoil from excavations within the construction area. The spoil can be arranged in manmade hills and berms outside the work area in such a manner that they are permanent. The hills or berms may then be seeded, mulched, and planted with native trees and shrubs during construction. This will permit additional growth to occur before the project is completed. Another method of screening construction areas is to select places where no construction will occur and plant naturalistic groups of trees and shrubs there at the start of construction.

7-5.2.1.8. Preservation of existing trees when grades are changed.

7-5.2.1.8.1. When the grade is to be raised around an existing specimen tree, a dry well should be constructed. Increasing the depth of soil over tree roots makes it difficult for air and water to reach the roots and may smother the tree. There are three general methods of protecting the tree.

7-5.2.1.8.1.1. Construct a dry well one to three feet (depending upon the size of the tree) from the tree trunk,

using flat field stone or brick with open joints (fig. 7-2). If the fill is over six inches deep, place a layer of crushed stone on the existing grade from the outer drip line of the branches to the dry well. Place vertical tile at intervals at the outer drip line of the tree to admit air to the root system.

7-5.2.1.8.1.2. Where a dry well is not used, place a coarse rock fill up to the trunk of the tree, covering a circular area at least 5 feet in diameter around the tree at existing grade and providing a surface ring around the tree as described in 7-5.2.1.8.1.1. above (fig. 7-3).

7-5.2.1.8.1.3. When the grade is to be lowered around an existing tree, the chances of survival are small. One method of prolonging the life of the tree is to construct a retaining wall from existing grade to the newly lowered grade around the tree at the outer drip line of the branches (fig. 7-4).

7-5.2.1.9. *Road construction.* Roadways are a major source of erosion from construction areas. Long access' roads significantly disrupt the natural drainage system. Roadways serve to intercept, concentrate, and divert surface runoff. This can result in severe soil loss from roadway surfaces, ditches, cut and fill slopes, and safety berms.

7-5.2.1.9.1. Poor location and construction of a roadway can result in the following adverse conditions.

7-5.2.1.9.1.1. Excessively long or steep grades can accelerate erosion.

Three Methods of Preserving Trees When Grade is Changed

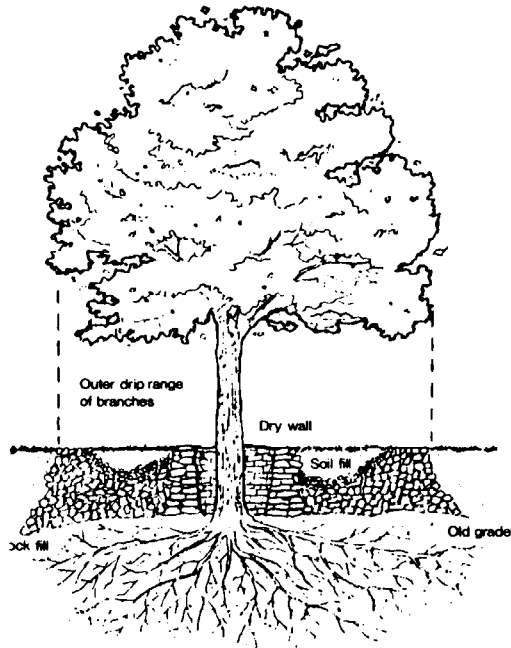

Figure 7-2.
With dry well

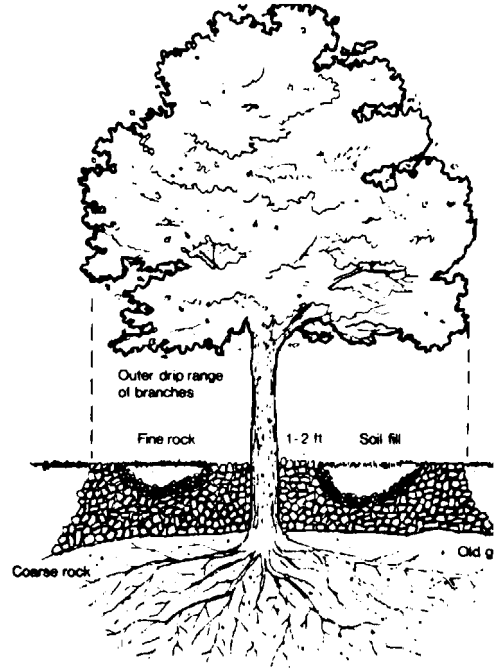

Figure 7-3.
Without dry well

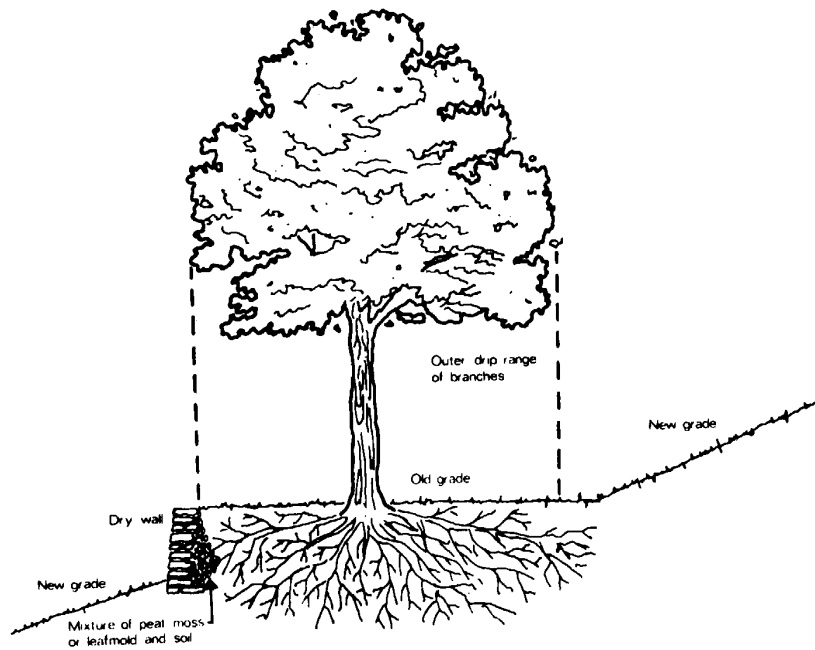

Figure 7-4. When grade is lowered

7-5.2.1.9.2. Disturbing unstable slopes or areas having a high ground-water table can result in landslides, muddy roadbeds, and destruction of vegetation.

7-5.2.1.9.1.3. Failure to preserve vegetated buffer areas can permit movement of sediment to nearby waterways.

7-5.2.1.9.1.4. Poor maintenance practices can result in excessive dust, runoff, and clogged ditches.

7-5.2.1.9.1.5. Inadequate stabilization of cut and fill slopes can lead to excessive erosion and landslides. Slopes steeper than 2:1 are difficult, if not impossible, to stabilize adequately with vegetation.

7-5.2.1.9.2. Every effort should be made to design a project so that construction roads become the permanent roads. All roads, temporary or permanent, should be properly constructed and well-drained, with shoulders and slopes vegetated to prevent erosion. Temporary roads should be treated with dust palliatives or penetrating asphaltic materials. Mulch and temporary vegetation should be applied on all side slopes of temporary roads. Roads which will become permanent should have the base course completed as soon as possible during the construction period. For additional information on haul and access roads see paragraph 15-12.

7-5.2.2. *Stabilization and landscaping.* Environmental protection during construction involves the improvement or restoration of all construction areas, borrow areas, and storage areas to as nearly natural conditions as possible.

7-5.2.2.1. *Finish grading.* Grades should be established according to design. Such grading should be coordinated with permanent structures and should include removal of all rocks and debris and preparation of the site for planting.

7-5.2.2.2. *Topsoiling.* If ample topsoil has been salvaged, all graded areas should be covered with a minimum four inches of topsoil. On slopes, the subgrade should be scarified before the topsoil is placed in order to better hold the topsoil in place. To avoid excessive compaction and caking, topsoil should not be worked when wet.

7-5.2.2.3. *Soil improvement when topsoil is not available.* When topsoil is not economically available, existing soil should be improved as described in paragraph 15-12.

7-5.2.2.4. *Permanent drainage control.* The permanent drainage system should be designed to handle maximum storm runoff. Structures used include stone riprap and various types of pipes, flumes, and sectional and flexible downdrains. The best type of structure depends upon site factors and the required service life. For detailed information on use, design, and construction of various

drainage structures see paragraph 6-4. and Erosion and Sediment Control: Surface Mining in the Eastern U.S. (app. E, no. 8).

7-5.2.2.5. *Control of burning.* The quality of the air as an environmental consideration is now controlled by law in many states. A serious infringement is the burning of wood, brush, and organic wastes. Instead of burning, chipper and shredder machines should be used to dispose of such material wherever feasible. The wood chips and ground-up wastes provide valuable mulch and soil improvement additives.

7-5.2.2.6. *Revegetation.* All disturbed ground areas should be stabilized with vegetative cover as soon as possible. See paragraphs 15-5 and 15-6 for information on the selection of grasses, legumes, and ground covers and on the establishment and maintenance of trees, shrubs, and vines.

7-5.2.2.6.1. *Temporary seeding.* This type of seeding should be accomplished to control soil erosion and dust concurrent with project construction (e.g., haul roads, slopes, shoulders, and drainage ditches). Fast-germinating grasses should be utilized.

7-5.2.2.6.2. *Permanent seeding.* This type of seeding should be accomplished after all construction has been completed. The appropriate type of seed will depend upon the planned use for the area, exposure, soil conditions, etc.

7-5.2.2.6.3. *Ornamental planting.* The planting of ornamental trees, shrubs, and ground covers should complement structures, frame special vistas, and screen unsightly views or facilities. Existing desirable trees on the site should be protected and utilized to the maximum extent feasible. In all cases, choices of plant materials should be made upon the basis of their adaptability to the area, climate, and soil types. A planting plan for the project should be prepared in advance by a landscape architect and implemented only when the project is virtually complete, or when there is no further danger from additional construction.

7-5.2.2.6.4. *Ground covers for special areas.* Where practical, various ground cover plants can be used as substitutes for grasses on slopes and in shady areas. Road slopes are a particularly good area for ground covers because their use can reduce the overall cost of maintenance.

7-5.2.2.6.5. *Reforestation.* Large areas not required for any project use, but retained for protective purposes, should be considered for reforestation. Once established, these reforested tracts can provide an effective screen of the project area as well as wildlife habitat. Eventually, the trees will represent a renewable,

marketable natural resource. These areas should be made a part of the installation forest management program. Installations without such a program should refer to paragraph 15-6 for information on establishing and maintaining tree cover.

CHAPTER 8. FERTILIZERS AND AMENDMENTS

8-1. Nutrient Requirements of Plants.

8-1.1. Major Elements. The major or primary plant food elements are nitrogen, phosphorus, and potassium. Calcium, magnesium and sulphur are often referred to as secondary plant food elements.

8-1.1.1. Nitrogen (N) promotes rapid vegetative growth and gives the plants a healthy green color. It is effective in protein production. Small amounts are stored in the organic matter in the soil. This frequently needs to be supplemented with nitrogen from chemical sources since most soils are deficient in nitrogen. Principle symptoms of nitrogen-starved plants are: stunted growth; pale yellow color, particularly the leaves; "firing" or burning of the tips and margins of the leaves, starting at the bottom of the plant first.

8-1.1.2. Phosphorus (P) is an active ingredient of the plant-cell protoplasm. It affects the rate of cell division, seed formation and plant hardiness. Many soils do not have adequate available phosphorus. Superphosphate is the common phosphorus carrier used to replenish phosphorus supplies. Some of the symptoms of phosphate-starved plants are: small growth; spindly stalk; delayed maturity; purplish discoloration of foliage or leaves of some plants; tips of older leaves often die; lack of or poor fruit and seed development.

8-1.1.3. Potassium (K) is essential to all plant growth. Its specific functions are not well understood but it is suggested that it stimulates some chemical processes, aids in the absorption of other elements into the plant, and helps the plant resist diseases, cold and other adverse conditions. Potassium, like nitrogen, leaches quite readily. Some soils, especially sandy ones, need applications of commercial potash. Some soils in the drier west have adequate supplies. Potassium starvation is common on most heavily cropped soils. The symptoms of a potassium starved plant are: plants grow slowly; margins of leaves develop a "scorched effect" starting first on the older leaves; stalk or stems are weak and plants "lodge" easily; seed or fruit is shriveled; plant's resistance to rusts and other diseases is reduced.

8-1.2. Minor Elements. Minor elements are often referred to as trace elements or micro-nutrient plant foods, since very small amounts in the soil solution are adequate for normal plant growth. These elements are boron, copper,

iron, chlorine, manganese, molybdenum and zinc. Present day fertilizer formulations, in addition to NPK, include specific minor elements to use on soils with a known deficiency.

8-2. Fertilizers.

8-2.1. Where Used.

8-2.1.1. Agricultural lands (outleases, wildlife food and cover plantings, etc.) Use fertilizers in accordance with approved agricultural practices adopted locally by state agricultural agencies. Outleasing contracts will require that the lessees use suitable and adequate fertilizers. The requirements will be realistic, so that leasing is of mutual benefit to the lessee and to the Government.

8-2.1.2. Recreation areas and parade grounds. Apply fertilizer frequently to provide a durable and lasting turf on physical training areas, such as ball fields, and on grass airfield runways, golf course fairways, and parade grounds that receive frequent and concentrated use, especially those that may be irrigated during extended droughts. Nitrogen is usually the principal element in which soils are deficient. Such areas require 2 to 5 pounds of nitrogen per 1,000 square feet annually. Apply mixed grade fertilizers as supported by laboratory soil tests.

8-2.1.3. Lawns, cemeteries, and parks. Use fertilizers on these areas only to the extent necessary to maintain an attractive and relatively weed-free turf. As with physical training areas, lack of nitrogen is the principal deficiency. Phosphate and potash are not usually required if laboratory tests show their presence in the medium or high ranges (para. 5-4). Silt and clay loams and similar fine-textured soils may not require fertilizers after grasses are well established. Sandy loams and similar coarse-textured soils may require 1 to 3 pounds of nitrogen per 1,000 square feet annually.

8-2.1.4. Open areas on improved grounds. Open areas and parkways not usually subject to traffic but maintained as improved will be fertilized only to the extent necessary to maintain a suitable cover for erosion

control. A grass-clover mixture typical of such turf in high rainfall areas may require a complete fertilizer (nitrogen, phosphorus, and potash) applied at moderate rates (100 pounds of 10-6-4 per acre). (White clover, hop clover, black medic, and lespedezas combined with bluegrass, bermuda, or carpet grass are typical mixtures.) Phosphorus is an important element for areas in which such legumes are grown, and potash is also important and may be deficient, especially in sands and sandy loams. Nonirrigated grasslands in low rainfall areas seldom require fertilizer, except during the initial establishment periods of one to three years.

8-2.1.5. Semi-improved grounds. Fertilize new plantings on roadsides, airports, heliports, ammunition storage areas, and the like as prescribed in chapter 15. Maintenance fertilization will be limited to amounts and kinds required to prevent loss of vegetation cover. In most areas, fertilizers should not be required.

8-2.1.6. Unimproved grounds. Generally unimproved areas will not require fertilization except for increasing density of vegetation for erosion control, agriculture out-leases, and for ponds or lakes. Fertilization requirements for agriculture leases should be included in the outlease as a conservation benefit. Fertilization of ponds and lakes would be for fish culture in accordance with fertility requirements for the local area.

8-2.1.7. Exposed subsoils. Exposed subsoils that have not been fertilized previously are commonly treated with a complete fertilizer at a heavy rate (100 pounds or more of each element per acre) to assure adequate supplies of nitrogen, phosphorus, and potash for early plant growth. Only nitrogen and phosphorus will be needed in arid sections.

8-2.2. Types.

8-2.2.1. Natural organic. Organic fertilizers are derived from animal and plant residues. Use of these materials is declining because many of the products bring a higher return as animal feed, their plant nutrient content is low, and handling costs are high. Such materials as bone meal, dried blood, fish scrap, tankage, and sewage sludge are the principal sources of organic nitrogen used in commercial fertilizers. Animal manures and composted vegetation are also sources of nitrogen. Organic sources of nitrogen are usually more costly per plant food unit than inorganic sources so that their use on DOD grounds areas is rarely justified.

8-2.2.2. Inorganic. Inorganic fertilizers are obtained from mineral deposits or synthetic materials. These materials are used separately or in formulating commercially mixed fertilizers. They are the most important source of plant

food.

8-2.2.3. Complete fertilizers:

8-2.2.3.1. Fertilizers containing nitrogen, phosphorus, and potassium are called complete fertilizers. State laws require that the percentage of each element be indicated on each bag of fertilizer. On these labels, the nitrogen content is expressed directly as nitrogen; phosphorus content is expressed in terms of phosphoric acid (P_2O_5), and the potassium content is given as potash (K_2O). The fertilizer grade is expressed in three numbers to indicate the percentage content of nitrogen, phosphoric acid, and potash—always in that same order. Therefore, a 10-6-4 grade of fertilizer is shown on the label as containing a minimum of 10 percent nitrogen, 6 percent phosphoric acid, and 4 percent potash. Likewise, a 20-0-0 grade of fertilizer contains a minimum of 20 percent nitrogen, but no phosphoric acid or potash.

8-2.2.3.2. Manufacturers of mixed fertilizers usually make sure that their products contain the other minor elements needed for healthy plant growth in the areas where their sales of fertilizer are anticipated. The trend of the fertilizer industry for many years has been to use the more concentrated types of fertilizer since the shipping, storage, and spreading costs are proportionately lower for high grade fertilizers than for those containing low percentages of plant food elements.

8-2.2.3.3. Purchases of fertilizers should be based largely on comparative costs of the units of plant food contained in the fertilizers, with consideration for the differences in unit costs for nitrogen, phosphoric acid, and potash. For example, a 10-5-5 and a 5-10-5 fertilizer each contain 20 percent of the plant food ingredients. However, since the nitrogen unit is most expensive, the cost per ton of the 10-5-5 grade is usually definitely higher than the 5-10-5 grade. Some mixed fertilizers have part of the plant food in organic form. Such mixtures serve a useful purpose for certain agricultural and gardening requirements, but their added costs can rarely be justified.

8-2.3. Kinds.

8-2.3.1. Nitrogen-bearing fertilizers. Nitrate fertilizers are essential for growing wear-resistant turf. There are many types and grades of nitrogen fertilizers. The common ones follow.

8-2.3.1.1. Nitrate of soda. Nitrate of soda is an inorganic

fertilizer which contains approximately 16 percent nitrogen. It is widely used in the humid eastern section of the United States and may be preferred for acid soils because it tends to correct the acidity. There are two types, a synthetic material and a product refined from natural deposits found in Chile. Continued use of this fertilizer is not recommended on heavy, imperfectly drained soil.

8-2.3.1.2. Sulfate of ammonia. Sulfate of ammonia is an inorganic fertilizer which contains approximately 20 percent nitrogen. It is widely used in the western section of the United States and is sometimes preferred on alkaline soils because the material tends to correct alkalinity.

8-2.3.1.3. Ammonium nitrate. Ammonium nitrate is an inorganic fertilizer which contains approximately 33.5 percent nitrogen. It is a widely used nitrogen fertilizer because of its relative low cost. Only the granulated or pelleted material should normally be purchased to avoid caking in storage. Important savings can be realized in some areas by the use of ammonium nitrate solutions, in which case, use a solution containing 60 percent ammonium nitrate and 40 percent water. The size of area to be fertilized determines the size of applicator equipment to be used. Applicator tanks ranging in size from 220 to 1,000 gallon units are in use. All parts of the applicator equipment which comes in contact with the ammonium nitrate solution, including tanks, pumps, hoses, nozzles, etc. should be of aluminum, stainless steel, rubber, neoprene, or asbestos, to avoid corrosion. Use pressure pumps operated from a tractor power-take-off or a small air compressor mounted on the side of a tank. Some burning of vegetation may be expected but the problem is not serious on bermudagrass. To reduce burning and loss of nitrates by vaporization, apply fertilizer solutions in the spring prior to rapid grass growth. On other grasses apply while the grass is dormant and the soil surface is adequately supplied with moisture, or thoroughly water in by irrigation promptly after fertilizer application. Wash off ammonium nitrate wasted on concrete pavement after treating adjacent areas to avoid deterioration of the concrete.

8-2.3.1.4. Organic materials. Organic fertilizers often have elements other than nitrogen, but nitrogen is the basic and most important element. The following percentages of nitrogen are typical of common organic materials.

<i>Source</i>	<i>Percent Nitrogen (by weight)</i>
Tankage.....	7.0
Cottonseed meal.....	7.0
Digested sludge	2.0
Activated sludge	6.0
Fish meal.....	8.0

Organic fertilizers are overrated as a means of increasing the organic matter in soils. The amount of organic matter added to the soil by normal rates of application is of minor consequence in terms of total soil volume treated. Organic forms of nitrogen are available to plants more gradually than inorganic forms, but the difference is not sufficiently important to justify paying a higher price for organic fertilizers for use on lawns and ball fields. Locally available sewage sludge has a certain amount of value for outlying areas, especially for mulching and fertilizing slopes and embankments. Its use near buildings or lawns often requires considerable expense in grinding, which may offset any expected economy.

8-2.3.2. Phosphate-bearing fertilizers. Applications of phosphorus are necessary for agricultural crops and for turf in which legumes are an important part. A heavy rate of application is used if turf plantings are made on exposed subsoils low in available phosphate. Some soils, clays in particular, combine with phosphate fertilizers to fix the phosphate in a nonavailable form. Consequently, plants that require considerable quantities of phosphate may require annual treatments. Most turf grasses as well as trees and shrubs will thrive on soils having only small amounts of available phosphorus. They may be able to use phosphorus not available to most agricultural crops. Common types of inorganic phosphate fertilizers are:

8-2.3.2.1. Superphosphate. Superphosphate contains approximately 20 percent available phosphoric acid and is the most common source of phosphate in the United States. The material is manufactured in pulverized and granulated forms. The granulated (or pellet) form may be preferable for certain clays in which phosphorus is unavailable. On grasslands, uniform application of phosphate is essential to assure efficient use of the chemical. Burning of the vegetation, which may be experienced with nitrogen-bearing fertilizers, is not a common problem.

8-2.3.2.2. Triple superphosphate. Triple superphosphate

is similar to superphosphate in fertilizing action and recommended uses. As the material contains 40 percent or more available phosphoric acid, the rate of application is half or less than half the rate of application for superphosphate. Double superphosphate and treble superphosphate are synonyms for triple superphosphate.

8-2.3.2.3. Rock phosphate. Rock phosphate is chemically untreated and the percentage of available phosphorus is low. Total phosphoric acid is variable, depending upon the quality of the original rock deposit, but normally runs 30 to 50 percent. Rock phosphate is more effective for acid soils than for nonacid soils. Do not use this material for improved grounds if the other phosphates, such as superphosphate, are readily available.

8-2.3.3. Potash-bearing fertilizers. Potash deficiencies are not as common as those of nitrogen and phosphorus, but are of considerable importance in some areas. Sandy soils are most likely to be deficient in potassium; clays are normally well supplied with this element. Turf requirements for potash are not high compared with those for some agricultural and truck crops.

8-2.3.4. Iron sulfate. Correct iron deficiencies with iron sulfate (known also as ferrous sulfate and copperas). Treat bermuda grass with dry iron sulfate at the rate of 12 pounds per 1,000 square feet. Fine turf is sensitive to this material. To prevent burning, apply at a rate of 2 ounces dissolved in not more than 5 gallons of water (11.5 grams of iron sulfate per gallon of water) for 1,000 square feet. Retreatments are necessary from time to time. Do not spray or spill on concrete walks and drives as unsightly discoloration results. Allow 4 or 5 hours after spraying before irrigating the area. Irrigate areas treated with dry material immediately.

8-2.3.5. Mixed fertilizers. Many combinations of nitrogen, phosphoric acid, and potash are widely used and commercially available. (See complete fertilizers, para. 8-2.2.3.)

8-2.3.6. Liquid fertilizers. Mixed-grade fertilizer solutions applied from water tank will not be used on military installations because of the added expense. Soluble forms of phosphoric acid are expensive and must be used in solutions which are costly to mix and apply. Nitrate solutions are sometimes useful and economical, and are authorized if savings in unit cost of nitrogen can be realized.

8-2.3.7. Slow-release fertilizers. The term, "slow-release", is used to define fertilizer which becomes slowly soluble over a period of time and, theoretically,

provides a uniform quantity of nutrients throughout the growing season. There can be a carry-over effect through the following one or two years due to residual fertilizer remaining in the soil. Turf response to a slow-release fertilizer program may not be fully effective until the second year. If immediate "green-up" is desired, slow-release application can be supplemented with a water-soluble source of nitrogen.

8-2.3.7.1. Advantages. The advantages of using slow-release rather than standard inorganic fertilizers include:

8-2.3.7.1.1. Reduction of labor since only one application per year is necessary versus three or more applications for standard fertilizer.

8-2.3.7.1.2. Little or no foliage burn since the nitrogen is released very slowly.

8-2.3.7.1.3. Ease of spreading which results in a more uniform distribution.

8-2.3.7.1.4. Continuous growth response due to residual effects.

8-2.3.7.2. Disadvantages. The disadvantage of using slow-release fertilizers include:

8-2.3.7.2.1. Expense. The cost of slow-release fertilizer is considerably higher than that of standard fertilizer.

8-2.3.7.2. Environmental condition. The rate of release is usually governed by the degree of moisture, temperature, and soil aeration, which may vary throughout the growing season.

8-2.3.7.3. Major types. The major types of slow-release fertilizers include: those in which urea has been incorporated in complex organic compounds, and whose availability depends either upon microbial action or water solubility; and those in which the inorganic compounds have been covered with plastics so that pellets or granular forms are produced.

8-2.3.7.3.1. Urea types. There are two chief urea types. One type is based on the combination of urea with formaldehyde (ureaform). Nitrogen is released as a result of the action of microorganisms, most readily at soil temperatures between 55°F and 85°F and where moisture and oxygen are plentiful. The other type is Isobutylidene diurea (IBDU) in which each molecule is a standard size and disintegrates by hydrolysis. IBDU is quite insoluble in water; therefore, it becomes available to plants very slowly. Since it breaks down by hydrolysis

rather than by soil organisms, its release may proceed in cold as well as warm weather. IBDU has a relatively long residual action.

8-2.3.7.3.2. Pellet types. The plasticized or pelleted forms of slow-release fertilizers contain phosphorous and potash compounds as well as nitrogen. They may be obtained in a variety of formulas, usually with high percentages of the available components. Some of these products use unreaformaldehyde as a nitrogen source, which extends the release period. The pellet is dependent upon temperature, moisture, and aeration for the most favorable results since it is decomposed by soil microorganisms. The thickness of the plastic coating varies among pellets, thus influencing the decomposition and availability of the fertilizer elements.

8-2.3.7.4. Slow-release fertilizers with organic substances. Some attempts have been made to incorporate ureaform fertilizers with natural organic substances. However, such attempts have provided little or no advantage over applying each one separately (albeit, at an additional labor cost). Slow-release fertilizers are just as dependent upon the proper physical condition of the soil as are inorganic fertilizers. Results may vary due to different site conditions and environmental influences. The cost of the material should be considered against the lessened cost of labor.

8-2.4. Precautions in Use.

8-2.4.1. Distribution. Uniform distribution of fertilizer is necessary. Modern fertilizer distributors provide economical and efficient distribution. Train personnel in broadcasting by hand onto small irregular areas so that each handful is carefully scattered and each subsequent "throw" is continuous with the preceding one. Distribute half the fertilizer in one direction and the other half at right angles for both mechanical and hand methods.

8-2.4.2. Soil moisture.

8-2.4.2.1. Apply fertilizers containing inorganic nitrogen (ammonium nitrate, nitrate of soda, or sulfate of ammonia) only to soils having adequate soil moisture. This is especially important for grasses other than bermuda.

8-2.4.2.2. Do not apply fertilizer to grass when the leaves are wet from recent rains or dew. This is an important precaution for fertilizers which contain inorganic nitrogen.

8-2.4.3. Timing. Some soils retain fertilizers for many months; others do not. Adjust applications to allow for this difference in soils. Experience with local soil conditions is the only basis for determination of this

characteristic. The entire annual fertilizer supply may be applied at one time on some soils and time of year is not important. On most nonirrigated, cool-season grasses, do not apply fertilizers in quantities greater than the needs of the grass for the ensuing cool growing season as applied elements may disperse during summer droughts before fall growth begins. Fall and early spring applications are preferred for nonirrigated cool-season grasses; spring and early summer applications for warm-season grasses.

8-2.4.4. Containers. Fertilizers are normally shipped in multi-walled paper bags. Standard size of bags for most military uses in 80 pounds. For shipment outside the United States, require that bags have a liner of plastic or other moisture proof material to assure the fertilizer arrives in dry condition.

8-2.4.5. Storage.

8-2.4.5.1. Do not store ammonium nitrate and nitrate of soda in buildings in which organic materials are stored.*

8-2.4.5.2. Purchase only enough fertilizer to supply installation requirements for one year or less. Continued storage results in broken bags and caked or wet materials. Store in dry shelters, even if storage time is only for a few weeks. Tarpaulins may be used for temporary protection for a few days.

8-2.4.6. Cleaning of spreaders. Clean fertilizer spreaders after each day's use to prevent corrosion and to assure efficient operation. In areas of high humidity, especially the tropics, do not leave fertilizer in the spreader longer than necessary to empty it. Some fertilizers under these conditions may begin to collect moisture and become unmanageable in about 30 minutes. (See Care of Equipment, para. 12-2.)

8-3. Soil Amendments. A number of materials other than fertilizers are useful for improving soils. Limestone, gypsum, sulphur, peat, and soil mixes are used in the maintenance of installation grounds.

8-3.1. Limestone. Limestone is used to make soils less acid. The approximate amounts of limestone (lime oxides) required to decrease the acidity of various soils by one pH unit are given below in pounds per acre:

*Both chemicals can be fire hazards when in contact with organic material.

Type of Soil	Organic Content		
	Low	Medium	High
Clay and silt loams	1,500	1,750	2,000
Loams	1,000	1,250	1,500
Sands and sandy loams	500	750	1,500

8-3.1.1. Ground limestone. Ninety-five percent of agricultural grades of pulverized limestone must pass an 8-mesh sieve; fifty percent must also pass a 100-mesh sieve. Local practice and state laws may specify other grades that may be sold. Limestone may be calcareous (calcium carbonate) or dolomitic (calcium magnesium carbonate). Calcareous limestone should contain at least 50 percent calcium oxide. Dolomitic limestone should contain at least 40 percent magnesium oxide. Dolomitic limestone is preferred wherever magnesium is lacking in the soil. Materials similar to ground limestone (e.g., ground seashells and marl) are available in some areas and are equal to calcareous limestone in agricultural value.

8-3.1.2. Hydrated lime. Hydrated lime is finely pulverized limestone from which the carbon has been removed by heating. Because of its relatively high cost, hydrated lime is used only at installations where ground limestone is not readily available.

8-3.2. Gypsum. Gypsum can be used as a soil amendment where alkalinity and poor soil structure, due to excessive salts, are problems. Certain sodium salts destroy the "crumb structure" of soils and cause poor drainage and unsatisfactory aeration. An excess of these salts will result in poor plant growth. Gypsum combines with sodium to become a soluble salt which is leached from the soil by rains or irrigation water. However, gypsum does not give satisfactory results in soils with a high water table or impervious subsoils. Gypsum has long been used as a soil conditioner, and its primary role is related to its flocculating action on the clay particles. The rate of application depends upon a number of factors such as soil type, fertility, organic matter, and vegetation to be grown. Test a small area before using gypsum in large-scale treatment. The following approximate application rates, in tons per acre, for various soil types are based upon a product containing 80 percent gypsum.

Type of soil	Application of gypsum
Sandy loams	1 ton
Silty loams.....	2 tons
Clay loams	4 tons
Heavy clays.....	6 tons

8-3.3. Sulphur. Occasionally, it may be advisable to use agricultural sulphur to lower the pH and to stimulate growth of certain plants, particularly those of the Family

Ericaceae (e.g., rhododendrons, azaleas, and heaths). Both sulphur and aluminum sulphate can be used, but powdered sulphur is preferred since it is longlasting, more effective, and less toxic to plants. Agricultural sulphur should be applied in moderate quantities, one to two pounds per 100 square feet, and worked well into the soil. Another one to two pounds per 100 square feet may be applied several months later if tests indicate that the pH is still higher than desired.

8-3.4. Peat. Peat is relatively undecomposed organic material. It consists of sphagnum moss and other substances produced in bogs and swamps. Peat persists in the soil for many years and is relatively free of weed seed. Peat is usually too expensive, except for small, heavily used areas of turf such as golf greens or football and baseball fields that pack and become hard under play.

8-3.4.1. Kinds.

8-3.4.1.1. Reed-Sedge. Reed-sedge peat may be easier to use than other kinds because the better grades are finely pulverized and do not require grinding. Reed-sedge peats are shipped either in bulk by car lot or in even-weighted bags. They may contain high percent-ages of moisture, often as much as 60 to 75 percent. Thoroughly air-dried material free from sand, soil, and other heavy impurities normally weighs from 10 to 20 pounds per cubic foot. For rough computations, 100 pounds of reed-sedge peat may be assumed to contain 40 pounds of oven-dried organic matter.

8-3.4.1.2. Sphagnum. Sphagnum peat is often more difficult to mix uniformly with soil than reed-sedge peat. The use of a hammer mill to pulverize the product may be necessary. Sphagnum peat is offered for sale in bales that weigh from 80 to 120 pounds. Moisture content of the product is less than reed-sedge peat, usually 30 to 60 percent. Air-dried, screened, or pulverized sphagnum peat usually weighs about six pounds per cubic foot. For rough computations, a standard-sized (36- X 18- X 18-inch) bale of sphagnum peat may be assumed to contain 50 pounds of oven-dried organic matter.

8-3.4.2. Procurement of large lots. When peat is purchased in considerable quantity, the supplier should be required to submit, at his expense, samples of the delivered material in a moisture- proof container to a state certified testing laboratory in order to determine moisture and ash analysis and percentage of organic matter. Samples from open bales may be composited,

or samples may be collected from unbroken bales with a sampling tube.

8-3.4.3. Procurement of small lots. In small-lot procurements of peat, the product should be acid or neutral grade as required and free of sticks, stones, toxic salts, and other objectionable material. It should contain 90 percent or more organic matter on an oven-dried basis. The type of commercial product required (i.e., bales, bags, or bulk) should be determined from local site conditions (e.g., size of project, source of materials, and available equipment). Bales of peat should be even-size standard bales of sphagnum peat measuring 18 X 18 X 36 inches. (Note: Sphagnum peat may need to be pulverized prior to mixing with soil.) Bags should be plastic-lined and contain not less than 100 pounds of reed-sedge peat which contains not more than 50 percent moisture on an oven-dried basis. (Note: Greater quantities of water are acceptable, but payment on competitive bids should be on the basis of 50 percent material.) Bulk peat should be reed-sedge peat procured on the basis of cubic yards of the bulk material.

8-3.4.4. Cost determination. Purchase products on the basis of cost per pound of oven-dried organic matter, delivered to the installation.

8-3.4.5. Application. Procurement information in subparagraphs 8-3.4.2 and 8-3.4.3 is also available when hiring contractors to furnish and mix material into a seedbed. Common practice in gold green construction is to measure peat by volume (10 to 20 percent or a certain number of cubic yards per 1,000 square feet). However, the weight basis is preferable since it takes into account the wide variations of organic matter in the various peat products. Four to five percent of oven-dried peat by weight is adequate for an original soil mix for construction purposes (including golf greens). Mature golf greens may contain from three to seven percent organic matter in the top 2 to 4 inches; greater percentages tend to increase disease in some grasses. Relatively few well-drained soils, even the dark-colored prairie soils, contain more than five percent organic matter. Peat should be mixed with coarse sand to make silt and clay soils useful as physical training areas. When using peat in topsoil, mix 50 pounds of peat (on an oven-dried basis) with each cubic yard of coarse sand or loamy sand, off the site where the mix is to be used. After grading and smoothing the seedbed, disk or cultivate the graded surface and apply the resulting soil-humus mix to a depth of 4 inches.

8-3.5. Soil mixes. Certain soils can be improved by mixing with other types of soils.

8-3.5.1. Sandy soils that do not hold moisture in sufficient amounts to support turf in improved ground areas require the addition of clay or other plastic soil material. The amount of clay that must be mixed to provide the desired moisture-holding quality depends upon the amount of sand present. Soils on which the prevailing

turf grasses can be grown only with difficulty, and which have a sand content over 75 percent by weight should receive 6 cubic yards of silt or clay loam per 1,000 square feet (approximately a 2-inch layer) before being planted for lawns, parade grounds, and similar heavy-use areas. The silt or clay loam to be added should be free of stones and toxic salts. Pulverize the loam as may be necessary, spread it as uniformly as possible over the area to be planted, and then mix it thoroughly into the top 2 inches of the original soil with a rotary tiller or a disk plow and cultivator-packer.

8-3.5.2. Clay soils which tend to form large fissures during periods of drought can be improved by adding sands. Mix approximately nine cubic yards of sand into the top three inches of each 1,000 square feet of original clay loam base. If the original soil is a clay, not more than 10 percent clay should remain in the final mix. This kind of improvement should be limited to athletic fields and other highly developed areas.

8-3.5.3. Topsoil of unspecified silt and clay content should not be used. Such applications generally result in adding more sand or other objectionable material or in introducing objectionable weed seed, wild onion, nut grass, and other such materials.

8-3.6. Topsoil and soil mixes. Topsoil can be defined as any soil material on top of a site prepared for the establishment of turf. Soil material used for this purpose may be from surface or subsoil materials or may be mixture of soil, building sand, and peat. The addition of topsoil is an expensive component of a planting operation. Do not stockpile surface soil from a construction site for later use as topsoil unless the material, as determined by analysis is satisfactory for the use intended. Both mechanical and chemical analyses (chap. 5) are necessary for proposed topsoil sources and for the subsoil on which the topsoil is to be placed. Where extensive use of topsoil is planned, and time permits, make field tests as prescribed in chapter 5.

8-3.6.1. Light-Traffic turf. This category consists of lawns, cemeteries, infrequently used recreation areas,

roadsides, cut and fill embankments, ammunition magazines, and drainage channels.

8-3.6.1.1. Most sites in the above category can be established to suitable turf without topsoil; use topsoil only where necessary. Improve sandy soils by applying 2 inches of clay-loam, mulch, or other locally available, fine-textured material (6 cubic yards per 1,000 square feet) to the surface. Mix thoroughly into the soil with tillage equipment to provide a 4-inch sand-clay surface mix. In general, the use of sand to improve a clay soil for turf in the above category is not economical.

8-3.6.1.2. Where sloughing of a plastic soil occurs on embankments or ammunition magazines, use a 2-inch application of sandy-loam topsoil without mixing it into the existing soil base.

8-3.6.1.3. Where the planting site is principally gravel, shale, or other material which does not nourish and support plant roots, apply a minimum 4 inches of a locally available loam, preferably a clay- or silt-loam. Do not mix the loam into the sterile base but rather, till the surface of the base to loosen any compaction and to facilitate better bonding of the topsoil with the base. Avoid using any topsoil which has poor interior drainage for turf in the above category.

8-3.6.2. *Recreational areas and parade grounds.* This category of turf is used more or less continuously, such as playgrounds, ball fields, golf course fairways, parade grounds, and similar areas. Before restoring or constructing a site, evaluate soil conditions thoroughly to determine which problems must be corrected. Most soil surfaces will require improvement.

8-3.6.2.1. Correction of subsoil deficiencies may be necessary. Mix sufficient clay or other fine-textured material into deep sandy subsoils with tillage equipment to provide moisture-holding capacity. Use approximately 3 inches of clay-loam to provide an 8-inch, mixed subsoil base. For impermeable clay subsoils, use sand and peat to improve permeability and interior drainage.

8-3.6.2.2. After subsoil improvement, apply a 4-inch layer of suitable topsoil. Carefully evaluate available sources of soil material for topsoil use. It is especially important that the soil absorb rain and irrigation water at a rate of not less than one-half inch per hour (chap. 5). Rates in excess of one and one-half inches per hour indicate a soil which will cause turf damage from lack of moisture.

8-3.6.2.3. In ideal conditions, topsoil contains about 60 percent sand and the remaining 40 percent divided between silt and clay, with most of the fine texture represented preferably by clay. Excessive percentages

of silt and fine or very fine sand are objectionable because when compacted, they interfere with rapid interior drainage after irrigation and rains. This problem is seldom apparent on agricultural or undisturbed soils but becomes serious under compaction by foot-traffic. Some clay-loams can be improved for topsoil use by fortifying them with a sufficient amount of building sand to obtain the percentages of coarse sand, silt, and clay.

8-3.6.2.4. Most topsoils in the above category should be improved by adding about 50 pounds (on dry-weight basis) of reed-sedge or sphagnum peat per cubic yard soil mixture. Under many conditions, a formulated soil mix is necessary. Mix the material off the site, using coarse building sand, a clay-loam for the soil, and 50 to 100 pounds of peat (on a dry-weight basis) per cubic yard in combination with soil and sand. See subparagraph 8-3.4. for peat specifications.

8-3.6.2.5. Avoid clay-loams containing expanding or fat clays (e.g., montmorillonite). These clays expand and contract excessively and when mixed, even in low percentages with other soils, become unmanageable if compacted.

8-3.6.3. *Other turf.* This category consists of open, relatively level areas of unimproved grounds planted primarily for the control of dust and water erosion. Imported topsoil is not normally required for these areas. Use adapted species of grass, trees, or shrubs which do not require added topsoil.

8-3.6.4. *Tree and shrub planting pits.* This category consists of trees, shrubs, and vines which are planted in prepared pits and filled with improved soil mixes to assure initial plant survival. Most fertile sandy loams available locally are suitable. Where the existing soil is fertile and well-drained, imported soil material is not necessary. Where a suitable soil is not available locally, prepare a soil mix consisting of a material comparable to that prescribed for topsoil in subparagraph 8-3.6.2. For azaleas, and similar shallow-rooted species, use 100 pounds peat (on a dry-weight basis) per cubic yard of soil-sand mixture or natural sandy loam (i.e., approximately one part peat to four parts soil and sand by volume).

CHAPTER 9.
INSECTS, DISEASES AND ANIMAL PESTS OF
VEGETATION

9-1. General. Insect and disease damage is often difficult to identify. When vegetation becomes unhealthy for reasons not readily explained by infertile soil, lack of moisture or other common causes, inspect leaves and branches carefully. Consult appropriate publications, the installation pest controller and when necessary, the Major Command Entomologist, for insect identification and control methods. Plant disease specialists are not usually represented at military installations but professional advice on identification and control is generally available from state and Federal agencies servicing the area. The selection and application procedures involving pesticides for insect, rodent and disease control will comply with guidelines at appendix A, no. 9.

9-1.1. Guidance in modifying existing pest management programs, to include utilization of integrated pest management (IPM) principles, is contained in chapter 2, section 3, of the Military Entomology Operational Handbook (app. A, no. 10). Integrated programs include chemical, biological, sanitary and regulatory control techniques. Preventive treatment should be stressed whenever possible. Included are measures such as:

9-1.1.1. When obtaining new plant material select those most resistant to disease and insect attack.

9-1.1.2. Fertilize and water vegetation as necessary to maintain it in a healthy condition.

9-1.1.3. Prune woody plants with priority on removal of weak, superfluous, damaged or diseased material.

9-1.1.4. In areas under forest management perform silvicultural practices which prevent, or limit the severity of, insect and disease outbreaks (e.g., planting mixed species where possible; sanitation cuttings to remove damaged trees or those highly susceptible to disease or insect attack; prescribed burning to control certain plant diseases; and timber stand improvements (TSI) to eradicate host species that spread disease).

9-2. Insects. The Military Entomology Operational Handbook, TM 5-632/AFM 91-16/NAVFAC MO-310, contains valuable guidelines on insects which damage vegetation. These guidelines include, but are not limited to, identification, biological characteristics, vegetation affected and control.

9-2.1. Insects attacking turf. The many pests which destroy grassed areas are grouped by the methods of attack and types of damage. Some live in the soil and chew grass roots. Others live above ground and chew the grass leaves and stems. Still others suck the juice from the plants.

9-2.2. Insects attacking shrubs, shade trees and forested areas. Insect pests that infest trees and shrubs may be classified by three types of plant damage: chewing or defoliating insects; sucking insects; and borers. Some insects carry bacterial, fungal or viral diseases, e.g., elm bark beetle transmits the Dutch Elm disease which is caused by the fungus "Ceratostomella ulmi".

9-2.3. Control. The Handbook in paragraph 9-2 above, contains effective and economical chemical control recommendations including proper insecticide application, and the selection of equipment. Individuals responsible for insect control should also avail themselves of the assistance generally available through the extension service specialist in entomology for the specific state involved. Continuous coordination with such professional personnel is recommended.

9-3. Diseases. Effective and economical control measures are not generally available for some diseases such as, Dutch elm disease, phloem necrosis and oak wilt. The Military Entomology Operational Handbook (para. 9-2) does not include disease control. The following information provides guidelines on the use of fungicides for disease control on vegetation:

9-3.1. Fungicides. Fungicides are substances which kill or inhibit fungi and other plant pathogens on or in plant tissue. Fungicides containing such heavy

metals as mercury, cadmium, and zinc, which actually kill fungi spores, have been banned by the Environmental Protection Agency. Therefore, the majority of fungicides in common use are repellants or protectants which prevent the spores of fungi from germinating and infecting the foliage, fruit, or other parts of a plant. It is usually necessary to repeat applications of fungicide frequently in order to maintain a covering on the plant. Commonly used fungicides and the diseases they control are indicated in table 9-1, "Effective Fungicides for Disease Control in Landscape Planting".

9-3.1.1. Physical types. The principal physical formulations of fungicides are:

9-3.1.1.1. Dusts, in which the chemicals are mixed with a powdered carrier such as talc or clay for uniform distribution.

9-3.1.1.2. Wettable powders, in which the chemicals are maintained in suspension with water for spray application.

9-3.1.1.3. Emulsions, in which the chemicals are combined with a solvent and emulsifier which permit mixing with water for spray application.

9-3.1.2. Chemical types. The principal biological and chemical classes of fungicides are:

9-3.1.2.1. Antibiotics. Only a few antibiotic substances have proven effective in disease control and those only for a few specific diseases. Two antibiotics which are useful are Cylohexamide and Streptomycin.

9-3.1.2.2. Complex organic compounds. Included in this class are dithiocarbamates and dinitro compounds.

9-3.1.2.3. Sulphur. Sulphur is a well-established, inexpensive fungicide, but it is less efficient than the modern organic compounds. Sulphur is available in three

forms: finely ground dust, colloidal paste, and wettable powder. The mixture, lime-sulphur, is commonly used in the late dormant season to provide protection against early spring infection, but is largely supplanted by newer synthetic fungicides with a milder action on plants.

9-3.1.2.4. Copper. Copper is an old, reliable fungicide. It is the basic component of Bordeaux mixture which is one of the most effective repellants of infection, although it is somewhat unwieldy to prepare. Other copper compounds, termed "fixed coppers", are available under various trade names and are also quite effective (table 9-1). Copper-Count N is a newly developed, water-soluble copper which changes to a colloidal gel upon drying and thus protects foliage for a relatively long period of time. Although still somewhat experimental, Copper-Count N will probably supersede other forms of copper as a fungicide.

9-3.1.2.5. Systemics. A systemic is a substance which when applied to one part of a plant, is absorbed and translocated throughout the entire plant system. The principal fungicidal systemic, at present, is Benomyl and its derivatives. However, the use of systemics is still in the experimental stage and is not generally recommended.

9-3.2. Application. Since fungicides are included among pesticides, they are subject to regulation by both Federal and state agencies. A fungicide must be applied only to the plants noted on the label of the container and in accordance with the methods prescribed. Applicators must know the identity of the disease or plant pathogen they wish to control and then select the proper fungicide.

Table 9-1. Effective Fungicides for Disease Control in Landscape Planting

Disease	Common name	Trade name
General Control (Should kill or deactivate any spores.)	Benomyl (systemic)	Benlate
	Bordeaux mixture	Bordeaux mixture
	Captan	Orthocide
	Chlorothalonil	Bravo
	Copper compounds	Copper-Count N, Kocide
	Dexon	Dexon
	Dodine	Cyprex
	Lime:sulphur	Lime-Sulphur
	Sulphur (wetable)	Sulphur Dust
	Thiophanate methyl (systemic)	Zyban, Fungo
	Thiram	Thylate, Tersan, Arason
	Zineb	Diathane, Parzate, Zineb
	Ziram	Zerlate
Blight	Maneb	Manzate
Fire Blight	Streptomycin (antibiotic)	Agrimycin
Leaf Spot	Dyrene	Dyrene
	Ferbam	Fermate, Karbam, Coronate
	Folpet	Phaltan
	Glyodin	Crag 341, Glyodex
	Maneb	Manzate
Mildew	Cyclohexamide (antibiotic)	Acti-Dione
	Dinocap	Karathane, Mildex
Root Rot	Pyroxychlor	Nirelle
Rust	Cyclohexamide (antibiotic)	Acti-Dione
	Ferbam	Fermate, Karbam, Coronate
Scab	Ferbam	Fermate, Karbam, Coronate
	Glyodin	Crag341, Glyodex
Soil-borne Fungi	Carboxin (systemic)	Vitavax
	Chloroneb (systemic)	Tersan
Soil Fungi	Banrot (soil drench)	Banrot
	Vapam (fumigant)	Vapam

9-4. Animal Pests.

9-4.1. Animals which are a nuisance to the extent that they sometimes require control in maintaining natural resources areas at military installations include: migratory birds, rodents, muskrats and beavers, deer, rabbits, snails and nematodes.

9-4.1.1. *Birds*. Primary areas where birds are a nuisance:

9-4.1.1.1. Concentrated roost areas where fecal deposition on limbs and ground areas can cause death of the trees.

9-4.1.1.2. Airport runways or flight lanes.

9-4.1.1.3. Rest and/or feed areas such as parade grounds & athletic fields.

9-4.1.2. *Rodents*. Woodchucks, pocket gophers, prairie dogs, ground squirrels, field mice and moles, damage ground areas by extensive burrowing and by seriously damaging or killing adjacent plants.

9-4.1.3. *Muskrat and beaver*. These animals damage, or disrupt, drainage facilities by burrowing into impoundments and blocking outlet structures causing

flooding of highways.

9-4.1.4. *Deer and rabbits*. They can do extensive damage to trees, shrubs and other plantings. Damage varies from girdling young tree trunks to biting off, or eating, succulent terminal growth of both annual and perennial plants.

9-4.1.5. *Snails and slugs*. These pests are a nuisance mainly to tender green plants in improved ground plantings, annual and perennial plant beds, and vegetable gardens. They prefer habitats offering shelter, adequate moisture and abundant food supply.

9-4.1.6. *Nematodes*. They are one of the most important biological and mechanical factors in soil buildings. However, those with which we are here concerned are parasites of plants. Damage affects

roots, stems, leaves, and seeds of many agricultural and horticultural plants. Nematodes can be particularly destructive to lawns and golf course turf.

9-4.2. Types of Control. Control measures include grounds maintenance and sanitation practices; chemical treatments; mechanical treatments; biological controls; and, compliance with state and Federal quarantine procedures to prevent destructive and harmful pests from spreading to uninfested areas.

9-4.3. Methods of Control. Hunting and trapping at military installations are primary controls of those pests considered game animals. (See AR 420-74, DA PAM 420-7; AFR 126-1; MCO P11000.8; NAV- FAC INST.

11015.4.) Helpful guidelines for animal pest control are contained in the Natural Resources Fish and Wildlife Management Manual (app. A, no. 4) and in the Military Entomology Operational Handbook (app. A, no. 10). The US Fish and Wild- life Service, and the respective state fish and game or conservation department, provide assistance in control of many pests (e.g., black birds, ground squirrels, and beavers). The Air Force Bird/Aircraft Strike Hazard (BASH) team (HQ AFESC/DEVN, Tyndall AFB, FL 32403) provides consultation and assistance for bird control on Air Force installations.

CHAPTER 10. FIRE PROTECTION ON MILITARY LANDS

10-1. Fire Prevention

10-1.1. Objectives. The purpose of fire prevention is to reduce the number of fires caused by arson to the lowest practical minimum. In planning and action, prevention efforts should be on a parity with other phases of fire control. Fires on military lands within the natural resources program are especially hazardous due to the storage of equipment, ammunition, and supplies; the potential obstruction of airfields and roads by smoke; and the multiple use of these lands for training, military operations, timber production, wildlife habitats, and outdoor recreation. Military training exercises scheduled for field areas (FTXs, JFTXs, etc.) require advance preparations and well-developed plans for fire prevention.

10-1.2. Fire Report Analysis. An analysis of the problem with which prevention must deal requires that localized risk and hazard surveys be made periodically to determine when, where, and why fires occur. Fire reports on all previous fires located on the base map should be available for analysis. Installations having a large forest fire occurrence may find it necessary to use a new map each fiscal year; those with a low incident of forest fires can maintain the same location map for a five year period. All fire location maps will be retained in permanent files. It is necessary to review these reports for planning purposes.

10-1.3. Education. Fire prevention education is a year-round job which must be intensified during the spring months and throughout the fire season. Every available device should be used at these times. All installation personnel should be kept informed of fire danger or hazardous fire conditions. Signs and posters should be placed in appropriate places. Articles and notices with

pictures in various daily bulletins and local newspapers are effective in getting across fire prevention methods. Military dependents may be made aware of forest fire danger and prevention by utilizing the Smokey Bear Program in the grade schools on the installation. Teaching aides and materials for conducting school programs may be obtained from Cooperative Fire Protection-Forest Service, U.S.D.A., Washington, D.C. 20013, ATTN: Smokey Bear Manager. Radio spots and TV films are also effective and can be obtained from the Forest Service (app. D, no. 3) and the American Forest Institute (app. D, no. 4).

10-1.4. Enforcement. Regulations governing action of installation personnel concerning forest and range fires are included in AR 420-74 and DA PAM 420-7; 126-1; NAVFAC INST. 11015.4 and MCO P11000.8. Included are instructions for cease-fire of incendiary ammunition and pyrotechnics when high fire hazard conditions occur.

10-2. Preparedness or Presuppression Activities.

10-2.1. Fire Detection

10-2.1.1. Fire Lookout Tower. Erection of lookout towers is justified when the protection of life and property is in the national interest, and when other means of detection (e.g., lookout towers and observation aircraft belonging to other agencies) are not available. The tower is usually a steel structure with an enclosed cab high enough to enable the lookout to see for 15 miles on all sides (fig. 10-1). Topography and weather influence the range of vision. One tower for 30,000 acres is normally the minimum. When specifically authorized, rugged topography may make a tower necessary for an area as small as 10,000 acres. Consult the state forester concerning design, spacing (in relation to existing towers), and operation.

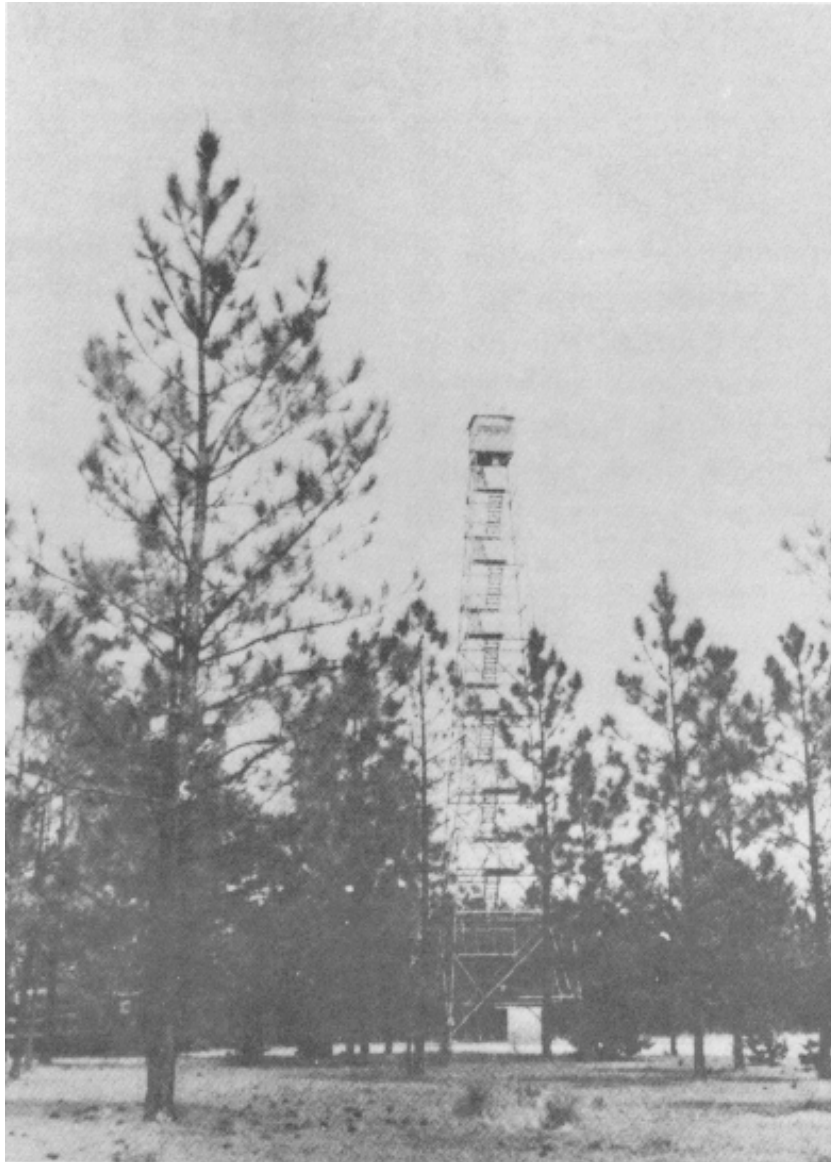

Figure 10-1. Fire lookout tower.

10-2.1.2. Firefinder. The firefinder is the instrument used by the lookout to determine the location of fires. Most standard firefinders consist of an alidade mounted to swing over a circle divided into 360° and oriented with

zero at true North (fig. 10-2). Consult the state forester concerning the appropriate type of firefinder for local conditions.



Figure 10-2 Firefinder.

10-2.1.3. Aircraft. Use aircraft, including helicopters, to the extent feasible to locate fires, transport materials, and direct suppression. Direct, two-way, air-ground radio communication is essential.

10-2.1.4. Ground patrol. Ground patrols are most valuable at small installations which do not have lookout towers or aircraft coverage, or when smoke prevents tower or aerial observation. The use of two-way radios is essential.

10-2.1.5. Fire protection grid map. The grid map is a map of the installation and its environs on which are shown military grid lines or latitudes and longitudes at

0°05' intervals (fig. 10-3). Each block formed by the lines is identified by a number in the upper left-hand corner. A lookout or patrol with a grid map can report the location of a fire to the dispatcher who should have an identical map. A transparent, overlay fire-location grid is convenient for more accurately identifying the location of a fire (fig. 10-4). The location grid is identical in size to a block on a grid map and should be placed over the appropriate block.

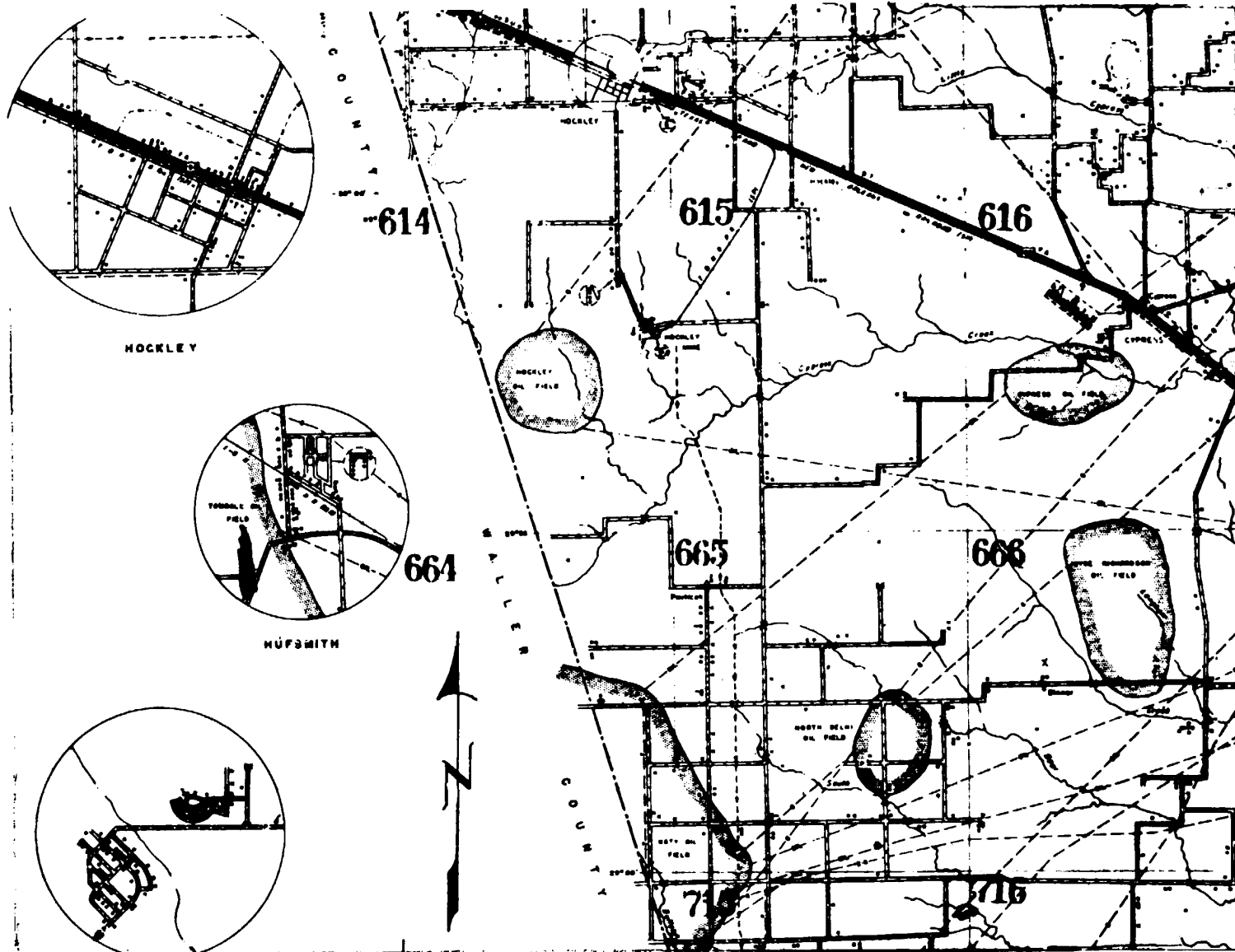

Figure 10-3. Fire protection grid map.

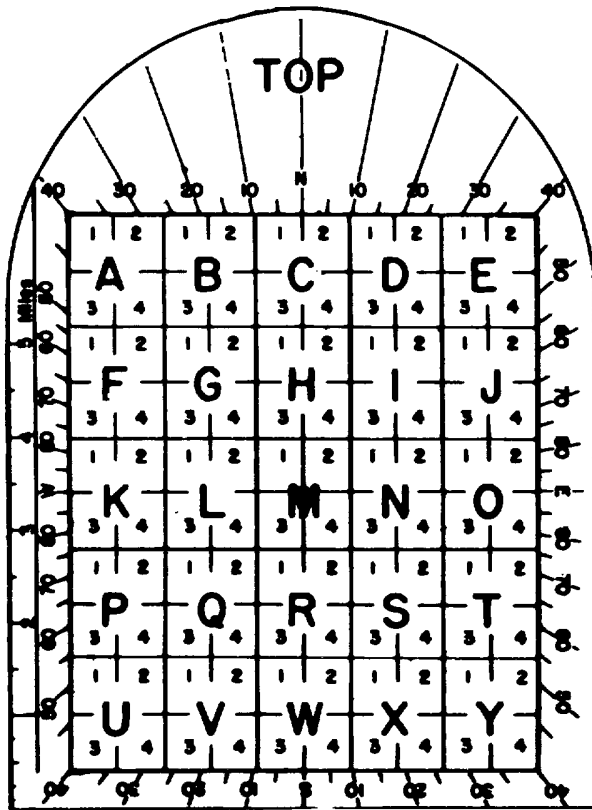

Figure 10-4. Fire locator grid.

10-2.1.6. *Plotting map.* Azimuth readings are required to locate fires in large areas of forest or brush land. Two or more lookout towers are necessary. Sightings can be made by patrol vehicles using compasses at known locations or observation points.

10-2.1.6.1. *Preparation.* Vertically place and mount on fiberboard a grid map at a scale of one inch equals one mile. Place a paper, 360' azimuth circle centered on true North, at each tower point. Make a small hole with a metal sleeve at each tower point and thread a fine cord through each hole. The cord should retract with a weight or spring behind the map. The other end (map side) of the cord should be fastened to the map with a glass-headed tack.

10-2.1.6.2. *Use.* Stretch each cord in the direction of and beyond the fire, as reported by telephone or two-way radio from each tower. The intersection of the readings of two or more towers will show the location of the fire (fig. 10-5). Use the grid map to report the location to the fire boss or higher authority. Operation of the plotting map is normally done by the dispatcher. When a number of smokes are visible from the towers at

the same time, be sure that the lookouts are observing the same smokes.

10-2.2. *Training.*

10-2.2.1. *General.*

10-2.2.1.1. Develop well-organized, trained crews. The fire marshal should select the fire boss after careful screening of available personnel who may include the department chief, the installation forester, the natural resources planner, or the grounds foreman. Straw bosses may be trained to assume duties on large fires. Natural resources and forest management civilian personnel should be used to the extent they are available. It is not advisable to weaken protection of built-up areas by committing structural firefighters to suppress outdoor fires if it can be avoided. Military personnel are most valuable as manpower pools when large or prolonged fires exhaust the regularly available civilian crews. Training in fire prevention and control should be given military personnel. The appropriate time is when new recruits are first inducted into the service. A 30- to 45- minute program can be conducted jointly by the Installation Fire Department and the Forestry Branch. Safety rules, fire behavior, and use of extinguishers, hoses and hand tools for fire suppression should be covered.

10.2.2.1.2. Select personnel for detecting and reporting (essential to prompt action). The key personnel are lookouts (in towers), ground patrols, air patrols, and dispatchers. On larger installations, all of the personnel may be required; on smaller installations, their duties may be combined as appropriate. The dispatcher assigns the first task force in the absence of the fire boss and notifies the higher authority.

10-2.2.1.3. When planning schedules, provide for the availability of suppression forces during periods of the year when hazards are high. Also provide good, portable two-way radios to permit crew flexibility and to allow other work to proceed.

10-2.2.2. *Training sessions.* Hold an annual fire training session, lasting at least 1 day, for fire crews. Discuss fire behavior, tactics, safety, equipment, and related information. A catalog for training films can be obtained from the Forest Service (app. D, no. 3). Key personnel should be sent to area training sessions held by federal, state, or private industry fire suppression forces. Additional information may be obtained from FIREBASE Operations Center, Boise Interagency Fire Center, 3905 Vista Ave., Boise, Idaho 83705. The National Wildfire Coordinating Group has current audio-visual training courses on wildfire management. For information contact National Audio-Visual Center, General Services

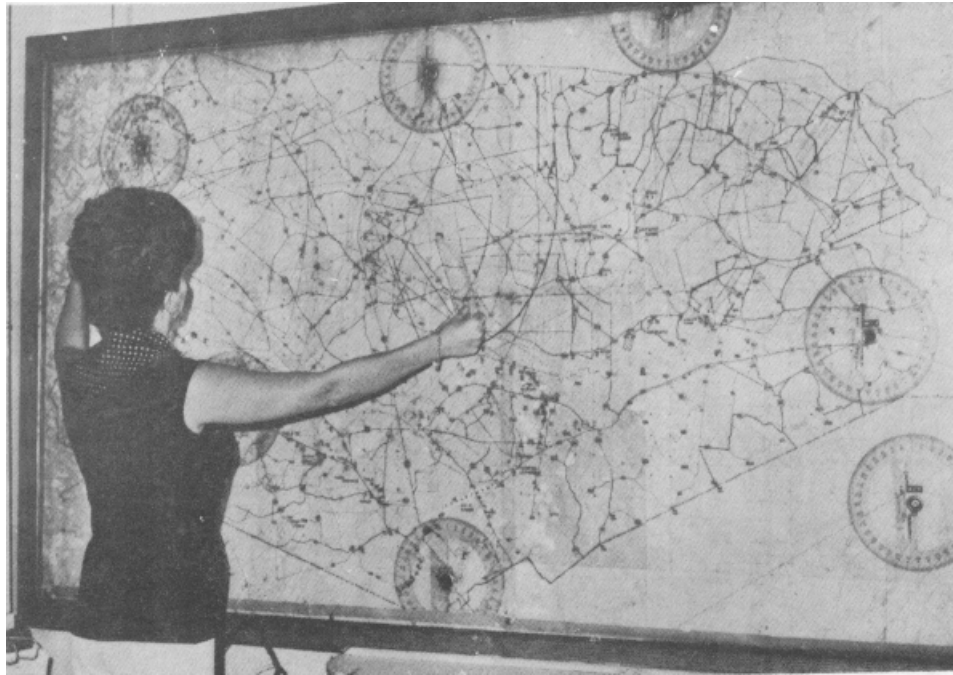

Figure 10-5. Locating fire at intersection of readings

Administration, Order Section/FH, WASH DC 20409.

10-2.2.3. *Safety.* Emphasize the following safety measures:

10-2.2.3.1. Send physically fit personnel to fight fires.

10-2.2.3.2. Require sturdy clothing, hardhats, and heavy shoes (preferably safety shoes). Flame resistant clothing (available through GSA supply) may be worn for fire suppression and prescribed burning activities. Artificial fiber should never be worn (e.g., polyester).

10-2.2.3.3. Provide built-in seats in trucks and require personnel to ride sitting down.

10-2.2.3.4. Transport tools in toolboxes or otherwise secure the tools to protect personnel from injury in transit.

10-2.2.3.5. Teach the safe way to carry and use hand tools.

10-2.2.3.6. Forest fire shelters should be available on fire suppression equipment, or carried by individual firefighters, when determined by severe fire hazard conditions. These shelters are available, with carrying case, through GSA as item number 4240-01-062-8226.

10-2.2.3.7. Do not work personnel to exhaustion. On fires of more than 8 hours' duration, arrange 8-hour shifts with periodic rest periods.

10-2.2.3.8. When cutting snags or trees, assign one person to watch for heavy, detached limbs and to warn

fellers and others nearby.

10-2.2.3.9. Qualify at least one member of each fire crew for first aid. Carry one first aid kit per crew.

10-2.2.3.10. Teach personnel never to try to outrun a fire, but to move to the flanks (or inside the burned area, if that area has cooled and can be reached safely).

10-2.2.3.11. Provide an escape route for each crew.

10-2.2.3.12. Teach crew personnel to stay with and under the direction of their crew boss.

10-2.2.3.13. Locate on maps all heavy, flammable growths that represent special hazards, including areas contaminated with explosives or duds. Also include gasoline or other fuel storage areas. Remember that gasoline fumes flow down into low-lying areas and can act as a fuse if there are any leaks.

10-2.3. *Hazard Reduction.* The prevention of fires by controlling the quantity, arrangement, continuity, ignitability, or burning rate of forest and range fuels can be accomplished by hazard reduction. This includes removing fuel exposed to sources of high risk, limiting the spread of fire after ignition, and preventing the buildup of heat energy. The use of herbicides, fire retar-

dants, prescribed burning, and mechanical equipment in hazard reduction projects should be regulated by environmental considerations. Helpful publications on hazard reduction/fuel (vegetation) management are listed in the bibliography (app. E, no. 3).

10-2.3.1. Vegetation conversion. On arid and semi-arid, nonforest lands, the volatile fuels are chaparral, sagebrush, and juniper. Conversion of the volatile fuels not only lowers the fuel volume but also lowers water use by the vegetation, provides forage for livestock and wildlife, and improves wildlife habitats. When converting chaparral to grasses, all woody top growth should be completely removed or destroyed. Brush not only prevents the establishment of grasses but also interferes with sowing grass and spraying brush regrowth.

10-2.3.1.1. Destroying chaparral. There are several methods of destroying chaparral: hand-cutting and grubbing, bulldozing, disking, roller chopping, hydro-axing or kershawing, chaining (pulling a large, heavy chain between two dozers), and prescribed (controlled) burning (fig. 10-6). Economically, prescribed burning is the most desirable method if the areas are located where burning can be accomplished safely. The elimination of chaparral by fire involves two operations: preparation of the fuel and broadcast burning of the brush fuel. The chaparral should be prepared in such a way that it burns readily and assures a complete kill. It burns better when all of the fuels are compacted close to the ground. Crushing can be accomplished by a bulldozer blade, chopper, or land-clearing machine such as the hydro-ax. Where heavy brush is dominated by oak and other large, shrubby stands, it should be snapped off rather than pushed out. In light or medium brush, herbicides can be used effectively. Quick-acting contact herbicides should be used when the spraying-burning interval is short. Slow-acting, desiccant, Phenoxy-type herbicides are recommended during the peak of the plant growth in the spring, for burning in the following fall or spring.

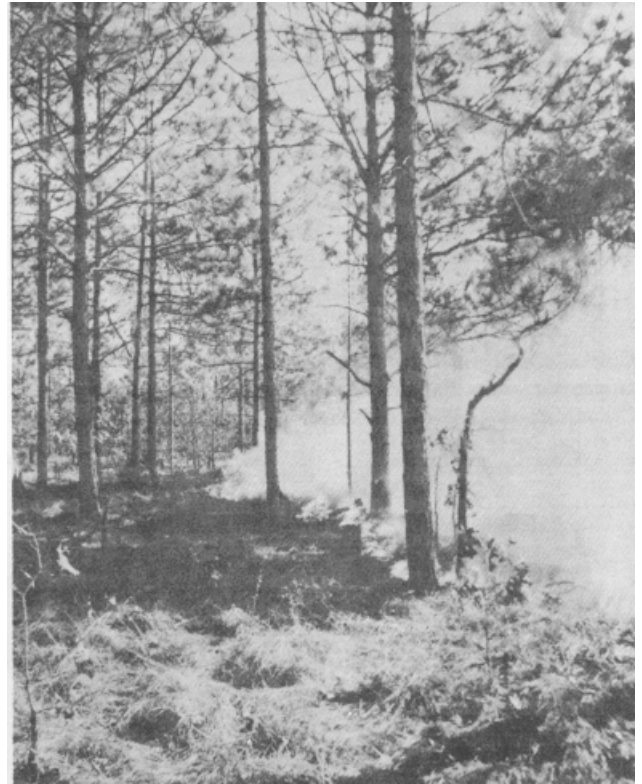

Figure 10-6. Prescribed burning in progress.

10-2.3.1.2. Improving grass cover. After burning, an improved grass cover should be established during the first year. The grasses should be sown soon after brush removal so that the vegetation will cover the soil quickly. Mixtures of four or more perennial grasses are recommended to assure a good vegetative cover on sites where they can be established. Perennial grasses are superior to annuals. Recommended perennial grasses for use in California and other parts of the southwestern United States are listed in table 10-1. Drilling with a rangeland drill where topography permits is the most successful method for establishing grasses. Broadcast sowing is necessary where the terrain prohibits the use of machinery. Timing is critical for broadcast sowing. Seeding by helicopter has proven effective on steep terrain. Early fall sowing, before the first rains, is recommended, especially for soils that are easily compacted by rain. Early sowing is not as essential on sandy loam soils that remain mellow after receiving several inches of rain.

Table 10-1. Rates of Drill Sowing on Suitable Sites by Species and Climatic Zones^a (Pounds per acre^b)

Species	Climatic zone			Upper Inland	Desert
	Coastal	Lower inland			
		Central California	Southern California		
Hardinggrass (<i>Phalaris tuberosa</i> L. var. <i>stenoptera</i> (Hack.) Hitchc.)	2	2	2	-	-
Smilograss (<i>Oryzopsis miliacea</i> (L.) Benth)	1	1	1	-	-
Veldtgrassd (<i>Erharta calycina</i> Sm.)	1	-	1	-	-
Wheatgrass:					
Intermediate (<i>Agropyron intermedium</i> (Host) Beauv.), pubescent (<i>A. trichophorum</i> (Link) Richt.), tall (<i>A. elongatum</i> (Host) Beauv.), or any combination	1	2	2	5	3-4
Crested wheatgrass (<i>Agropyron desertorum</i> (Fish) Shult.)	-	-	-	-	-1
Goars tall fescue (<i>Festuca arundinacea</i> Schreb.)	1	1	-	-	1
Orchardgrass (<i>Dactylis glomerata</i> L.)	-	-	-	.25	-
Sherman big bluegrass (<i>Poa ampla</i> Merr.)	-	.5	-	-	-
Blando brome (annual) (<i>Bromus mollis</i> L.)	.25	.25	.25	-	-
Total	6.25	6.75	6.25	6.25	4-5

^a "Conversion of Chaparral Areas to Grasslands", Jay R. Bentley, U.S. Department of Agriculture, Forest Service, Pacific Southwest Forest and Range Experiment Station, Agricultural Handbook No. 328, Berkeley, California, 1967.

^b Double rates for broadcast sowing.

^c Above 3,500 feet (mainly in southern California).

^d Recommended only for sandy loam soil in southern California. Replace by Hardinggrass or a wheatgrass in other areas.

10-2.3.1.3. *Preventing brush reestablishment.* Brush reestablishment can be controlled by periodic use of herbicides. The interval is generally two years. Two to four such treatments should completely control competing chaparral. Only EPA registered herbicides will be used.

10-2.3.2. *Prescribed (controlled) burning in southern pine region.* Prescribed burning involves planned use of fire, with preplanned intensity, which is applied to a predetermined area to reduce hazardous fuels, prepare sites for seeding and planting, control understory hardwoods, control disease, improve wildlife habitat, improve forage for grazing, enhance appearance, and improve access. Annual burning may be necessary on impact areas and on firebreaks around danger areas such as those used for ammunition and equipment storage structures. Three to seven-year burning intervals may be necessary for fuel reduction, control of undesirable understory in pine stands, maintenance of certain successional plant stages for wildlife, and control of brownspot disease in longleaf pine. Prescribed burning is also utilized to prepare chaparral brush areas for conversion to perennial grasses in arid or semi-arid areas and to improve native rangeland for domestic livestock and wildlife. The following rules for prescribed burning are essential:

10-2.3.2.1. *Preparation.* Do not proceed with prescribed burning until the fire protection plan for the installation has been approved. Include in the fire protection plan procedures to be used when conducting prescribed

burning. Coordinate the plan with appropriate training officers, the fire department, local forestry and fire protection agencies, and the local air pollution control board.

10-2.3.2.2. *Execution*

10-2.3.2.2.1. There are only a few days of good weather for prescribed burning during the year. When these days arrive, top priority should be given to accomplishing the burning. With good initial preparation, burning can begin without loss of time. A prescribed burning crew usually consists of one foreman and five to six helpers. With preparation, a crew of this size can handle a burn of several hundred acres. The foreman should be an experienced prescribed burner with an understanding of fire behavior and the terrain to be burned. The usual crew consists of three persons equipped with torches, two persons equipped with hand tools, and a tractor operator with a plow unit for emergency use. Radios for communication are almost a necessity for large burning jobs. Two vehicles are essential to permit maximum mobility of the crew. The foreman should have the crew ready to fire the area as early in the day as conditions permit, thus leaving maximum time for mop-up and patrol of the lines. Night is a good time to burn for hazard reduction except when severe burns are required. Night fires are usually cool fires when compared with day fires. A hot fire to eliminate young sweetgum, for example,

in mature pine stands in preparation for natural reseeding, should be burned in the daytime during the early fall or late summer when conditions are dry. The severity may also require a head fire, but this should only be permitted by experienced people.

10-2.3.2.2.2. Brief crews the day before burning and provide each foreman with a detailed map of his assigned area.

10-2.3.2.2.3. On the day of the burn, prior to setting the fire, notify coordinating offices and agencies cited in paragraph 10-2.3.2.1. above, and also military police, lookouts, and adjacent land occupants. Provide lookouts with map coordinates of areas to be burned.

10-2.3.2.2.4. Make a final check with the U.S. Weather Service. Defer burning if predictions are unfavorable for the next 12 hours.

10-2.3.2.2.5. Test burn with a small fire prior to setting large tracts.

10-2.3.2.2.6. Use burning procedures in accordance with the installation's approved fire protection plan.

10-2.3.2.3. Firing techniques.

10-2.3.2.3.1. General Various firing techniques are available to help accomplish a burn objective under different weather, topography, and fuel conditions. Burning objectives, fuels, and weather factors must be correlated closely with the proper firing technique to prevent harmful effects to the forest resources. Atmospheric conditions should be favorable for dissipating smoke into the upper air levels and away from smoke-sensitive areas such as highways, airports, and urban areas. Based on behavior and spread, fires either move in the same direction as wind (head fire), in the opposite direction to wind (backfire), or at a right angle to wind (flank fire); any fire can be described by these terms. As an example, a spot fire would develop all three types if allowed to burn long enough. The head fire is the most intense because of its faster spread rate (10 to 20 chains per hour), wider burning zone, and greater flame lengths. The backfire is the least intense, having slow spread rates (one to three chains per hour), narrower burning zone, and short flames. The flank fire intensity is intermediate. When slight variations in fuel volumes or prescribed weather conditions occur, consider combining two or more firing techniques to achieve the same result.

10-2.3.2.3.2. *Backfiring.* The backfire technique consists primarily of backing fire into the wind. Fire is started along a prepared base line, such as a road, plowed line, stream, or other form of barrier, and allowed

to back into the wind (fig. 10-7). Research indicates that variations in windspeed have little effect on the rate of spread of fire burning into the wind. Normally, such fire proceeds backward at a speed of 1 to 3 chains per hour. Backfiring is perhaps the easiest and safest type of prescribed fire, provided a steady wind (speed and direction) prevails. It produces minimum scorch and lends it- self to use in heavy fuels. Disadvantages include the time-consuming progress of the fire and the need for interior line plowing at frequent intervals, usually every 10 to 20 chains, to insure burning out of the strips. Stronger wind velocities (4 to 10 miles per hour, ground level) are desirable when using this technique so that smoke is well dissipated, and heat is prevented from rising directly into tree crowns. Burning on slopes has an effect similar to wind on the rate of spread. Downslope fires burning in the Piedmont, for example, would have much the same results as backfires in flat country. Factors in using backfire technique:

10-2.3.2.3.2.1. *Use in heavy rough.*

10-2.2.3.2.2. Use in small sawtimber and sapling-size stands and in plantations 12 to 15 feet or more in height.

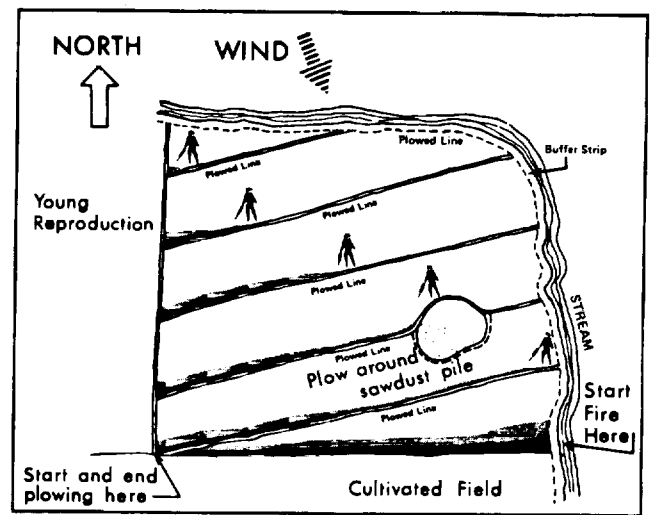

Figure 10-7. Backfire technique.

10-2.3.2.3.2.3. It can ignite large areas in a short time.

10-2.3.2.3.2.4. It requires stronger steady winds (optimum: 4 to 10 miles per hour, northerly or westerly).

10-2.3.2.3.2.5. It is not flexible once interior lines are plowed.

10-2.3.2.3.2.6. The base control line should always be secured with a burned-out strip.

10-2.3.2.3.2.7. It normally results in minimum scorch (about zero to 40 percent).

10-2.3.2.3.2.8. It can cost more due to the additional plowing needs on interior lines and extended burning periods resulting from the slower movement of the fire. Interior lines are frequently necessary to protect wildlife food and cover (i.e., special plantings), migration routes, natural fruit bearing plants, and buffer zones.

10-2.3.2.3.3. *Strip-head firing.* The strip-head fire involves setting a line, or series of lines, of fire upwind from a firebreak in such a manner that no individual line of fire can develop to a high energy level before it hits either a firebreak or another line of fire (fig. 10-8). The strips vary in width depending upon stand density, type, amount, and distribution of fuel, and desired results. Usually, strips should be about one to three chains apart. Frequently, a combination of strip-head fire and backfire is used to treat an area. The base control line is treated with a backfire; then, the remainder of the area is treated with strip-head fires. Compensation for minor wind direction changes can be made by altering the angle of striphead fire with the baseline. Also, adjustments for fuel density and composition can be made by altering strip widths. This method permits quick firing and smoke dispersal under optimum conditions. Occasionally, on small areas with light and even fuel distribution, a head fire may be allowed to move over the entire area without stripping to better accomplish the objective. Where this method is usable, it cuts down on the areas of increased fire intensity that would occur at the junctures of strip fires burning together. Caution: Be sure that fire will not escape control. Burn out a strip downwind with a backfire wide enough to control the head fire. Factors in using strip-head firing technique:

10-2.3.2.3.3.1. It can be used in most fuels, except very heavy roughs.

10-2.3.2.3.3.2. It should be used in medium-to-large sawtimber. It may be used for annual plantation maintenance burns after initial fuel reduction has been accomplished.

10-2.3.2.3.3.3. It can be used in flat fuels such as hardwood leaves.

10-2.3.2.3.3.4. It is fast and facilitates burning larger blocks quickly.

10-2.3.2.3.3.5. It can be used when relative humidity (40 to 60 percent) and fuel moisture (10 to 20 percent) are relatively high.

10-2.3.2.3.3.6. Successful winter use requires cooler

weather (20° to 50°F).

10-2.3.2.3.3.7. It can be used in summer or winter for hardwood control.

10-2.3.2.3.3.8. It needs just enough wind to carry fire (2 to 5 miles per hour, ground speed).

10-2.3.2.3.3.9. It is flexible; it can be easily adjusted for minor wind shifts up to approximately 45°.

10-2.3.2.3.3.10. The base control line should always be secured prior to area firing.

10-2.3.2.3.3.11. Flame heights will increase where head fires burn into the previous line of fire and, thus, increase scorch possibilities.

10-2.3.2.3.3.12. It is generally cheaper, requiring fewer plowed lines.

10-2.3.2.3.3.13. It is a good method for brownspo control.

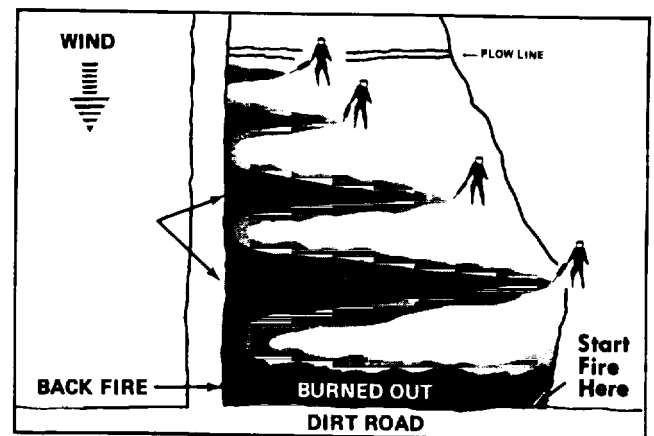
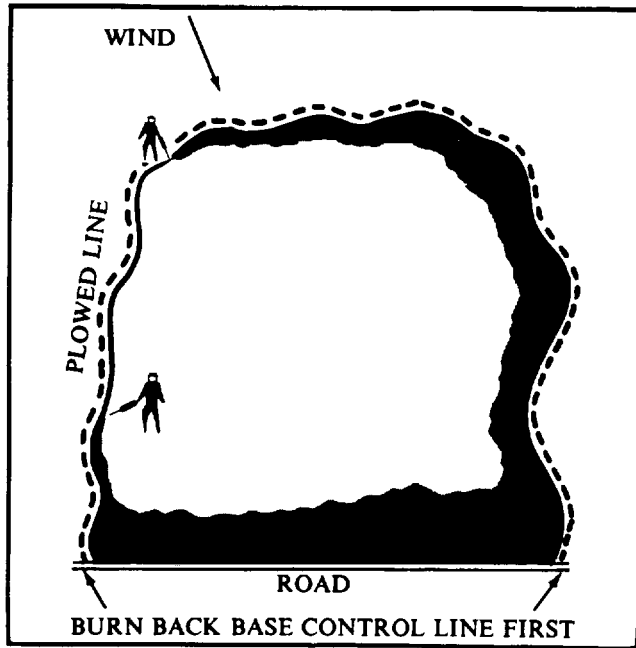

Figure 10-8. Strip-head fire technique.

10-2.3.2.3.4. Center and circular (or ring) firing. This technique is becoming more useful and better known, particularly in slash disposal efforts on cutover regeneration areas preparatory to seeding or planting. Ring firing is used on areas where a relatively hot fire is needed to reduce or eliminate logging slash and debris. As in other burning techniques, a base control line, usually on the downwind side of the burn area, is made secure with backfirings and flank firings. Once the baseline is secured, the entire burn area is circled with fire which is allowed to sweep over the area (fig. 10-9). Often, during periods of light wind, one or more spot fires near the center of the area can help pull the outer circle

of fire toward the center. Ring firing can generally be used in any season; weather conditions are not as critical as in other methods. However, caution is in order, particularly when weather conditions border on the unstable. Ring firing is conducive to developing strong and often violent convection columns, spotting up to one mile at times.



Ring Fire Technique

Figure 10-9. Ring fire technique.

10-2.3.2.4. Environmental effects. Prescribed burning has direct and indirect effects on the environment. In order to properly prescribe and then evaluate both benefits and damages of a burn, it is necessary to know how fire affects vegetation, soil, water, air, and wildlife. The timing of burns and burning techniques may be used to obtain a wide range of fire effects. Following are some of the effects on vegetation:

10-2.3.2.4.1. A major reason for prescribed burning is to reduce understory hardwoods and brush species, along with the litter that adds to fuel buildup. This must be accomplished by killing or consuming the understory without damaging the overstory.

10-2.3.2.4.2. Prescribed burning may injure or kill either part of a plant or the entire plant, depending upon how intensely the fire burns and how long the plant is exposed to the heat. In addition, the plant may have features (bark being the most obvious) which protect it from heat. The size of the tree stem is also a factor. Small trees of any species are generally easier to kill

than larger ones.

10-2.3.2.4.3. Most southern pine bark has good insulating qualities, while the bark on most hardwoods is not as effective. Therefore, hardwood trees are much more susceptible to fire injury. Pine trees four inches in diameter and larger have bark thick enough to protect the stem from damage by most prescribed fires. However, the crowns are quite vulnerable to temperatures greater than 130°F. For example, pine needles exposed to 130°F for less than five minutes will survive, while similar needles exposed to 1450F for only a few seconds will die.

10-2.3.2.4.4. Very high temperatures are produced in the flames of burning forest fuels. Fortunately, the hot gases cool rapidly above the flame zone and return to a few degrees above normal air temperatures a short distance from a prescribed fire. Nevertheless, adequate wind should be present to help dissipate the heat and keep it from rising into the overstory. Wind is also important in cooling crowns heated by radiation from the fire.

10-2.3.2.4.5. The temperatures of the air and vegetation at the time of burning are critical factors. A tree crown above a fire when the air temperature is 95°F would suffer about twice as much damage as a crown above the same fire in 40°F weather. The effect of high air temperature is recognized in using fire to control understory hardwoods. Summer burns generally kill more hardwood stems since less heat is needed to raise the plant temperature to the lethal level (fig. 10-10). Also, when plants are actively growing, they are more easily damaged by prescribed fire. The least damage occurs with dormant season burns. In areas with scenic values, needle scorch, bark char, and tree damage can be kept to a minimum by practicing appropriate timing.

10-2.3.2.4.6. Prescribed burning is generally not practiced in the management of hardwoods. While fire may not kill large diameter hardwoods, it will often leave scars through which insects and disease may enter. Pine may also suffer from bark beetle attack if a prescribed burn is too damaging, or if adverse weather conditions following the burn cause loss of tree vigor.

10-2.3.2.4.7. Many of the benefits from prescribed burning, such as reduced hardwood competition, increased grass for grazing, and improved conditions for wildlife, depend upon changes in the vegetative complex. The unwise use of fire may also alter species composition, but with adverse results, particularly if natural means of regeneration occur.

10-2.3.2.4.7.1. *Cessation of burning.* Discontinue burning if extreme, unforeseen weather conditions occur; e.g., a sudden sustained increase in wind velocity, rapid changes in wind direction, or a rapid drop in relative humidity, especially in areas of heavy fuel accumulation.

10-2.3.2.4. 7.2. *Patrolling.* Maintain a patrol until the fire is secure.

10-2.3.2.4.7 *Evaluation.* When burning to control understory in pine stands, inspect the sapling pines for

damage. For sapling longleaf and slash pines, one-third or less of the lower live needles should show scorch. Greater injury will necessitate revision of the procedures. Consult professional foresters before continuing the burn if young trees show a high scorch on much of the tree population.

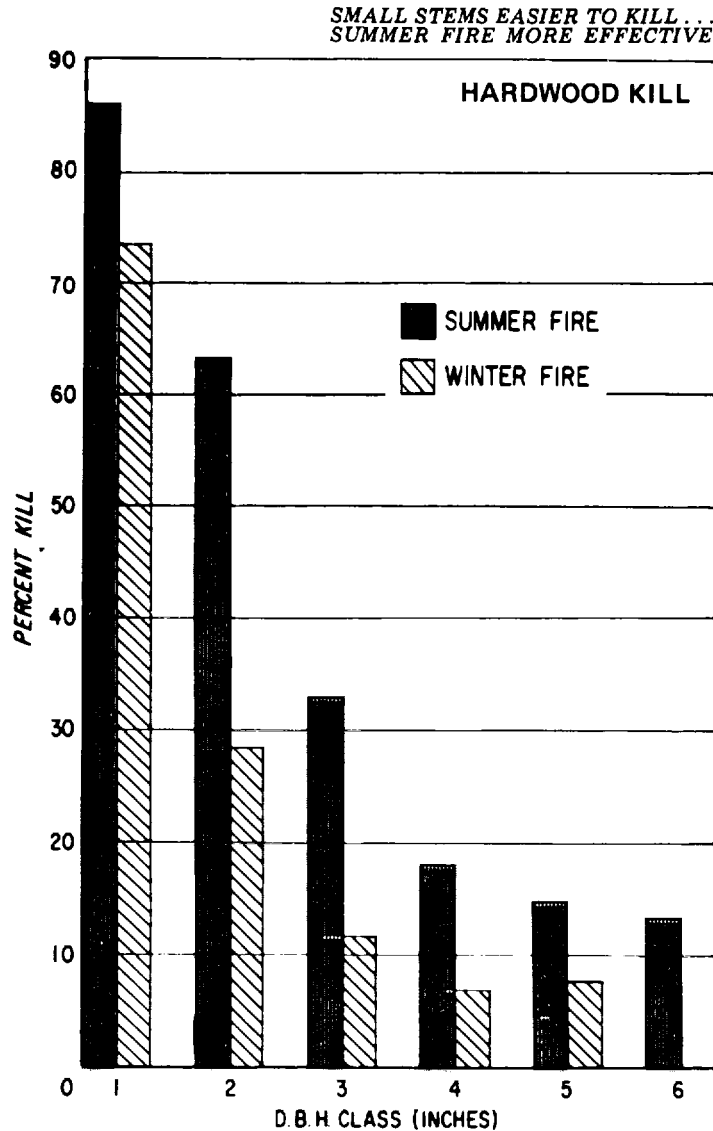

Figure 10-10. Hardwood kill comparison

10-2.3.3. Mowing. Firebreaks and roadside strips converted to grasses should be mowed at least twice during the growing season in order to maintain a low-fuel-volume ground cover if the fuel is not reduced by other means (e.g., grazing or herbicides). Consideration should be given to bird-nesting seasons so that mowing will not conflict.

10-2.3.4. Agriculture and grazing. On installations where the vegetative cover is predominantly annual and perennial grasses, controlled grazing by livestock can reduce the fuel hazard by keeping the grass height low.

10-2.3.5. Weed control In areas not adaptable to other types of fuel reduction, vegetation control practices, including herbicides and inorganic cover (e.g., gravel, stone and crushed rock), are appropriate. Equipment storage areas, road and railroad rights-of-way, and some firebreaks are among such areas.

10-2.3.6. Other. Slash treatment to lower the fuel

hazard in heavy, coniferous timber stands should be done soon after logging, depending upon season, topography, species, and degree of protection that can be provided. Slash treatment and disposal should be part of the timber sale contract in western forest regions. Slash should either be piled and burned in appropriate places, or lopped and scattered.

10-2.4. Firebreaks. Insure that all parts of an installation are accessible to fire-fighting equipment and personnel. Firebreaks not only slow fires but also can be used as trails to reach inaccessible areas. A system of trails and firebreaks provides greater use of the installation (fig. 10-11). A patrol road may be adequate as a firebreak; in some areas both may be required (fig. 10-12).



Figure 10-11. Fire-line construction using heavy fire-line plow.



Figure 10-12. Vegetated firebreak with rock-surfaced patrol road

10-24.1. Construction. Firebreaks often are not effective in stopping fires, particularly during periods of high-danger hazards. A 10-foot width allows use of most firefighting techniques, including backfiring, and may be considered a minimum width for permanent firebreaks. Greater widths may be necessary adjacent to highways and other hazardous areas.

10-2.4.2. Maintenance. Vegetated firebreaks are maintained by mowing. When fire hazard is extremely high, firebreaks devoid of all combustible material are required. These firebreaks are usually maintained with a patrol grader or bulldozer. Disk harrows with two to four three-disk sections are also suitable for such maintenance. Alternate plowing, with the disks set to throw the soil toward and then away from the centerline, is necessary. Selective herbicides are useful, especially in rugged terrain.

10-2.4.3 Erosion control. Firebreaks which have been plowed, burned, or treated with soil sterilants are not practicable in some areas due to soil erosion hazards. In adaptable sites, use perennial, sod-forming grasses and/or legumes which remain green during most of the year. Vegetated firebreaks require grazing or mowing. One or two annual mowings are normally adequate.

10-2.3.4. Fuel breaks. A fuel break is a wide strip in

which the native vegetation has been permanently modified so that fires burning within it are more easily controlled. In arid and semi-arid areas, the main purpose of a fuel break is to divide continuous natural fuels into smaller units. This aids in confining fires while providing quick access. The best location for a fuel break is on a ridge that permits access for motorized equipment. Canyon bottoms and mountain bases are also good locations. The width of a fuel break should be tailored to fit the terrain, fuel, and anticipated weather conditions. In heavy brush the minimum width is 200 feet, and in some areas, the width should be as much as 400 feet. On installations with chaparral vegetation, fuel breaks should enclose areas not exceeding 800 acres.

10-2.5. Access. A network of permanent roads connecting with fire trails (unimproved truck trails) should be designed to break the installation into desirable units. The roads not only act as firebreaks but also provide access for fire detection patrols and firefighting units and machinery. Roadbeds should be maintained for all-weather use.

10-2.6 Water availability. Water-storage areas such as ponds, lakes, streams, rivers, wells, and tanks should be identified on the installation's base fire map. Ponds, wells, and water tanks should be strategically located, and good access to these points should be maintained. Construction of necessary watering points, as well as maintenance of existing structures, should be part of the fire protection plan.

10.2.7. Equipment

10-2.7.1 Personnel transport. Provide adequate transportation for personnel and their equipment to fires. Use 1/2-ton, four-wheel-drive pickups or jeeps for the fire boss, crew bosses, scouts, and messengers. Use 3/4-ton pickups to haul 3- to 6-person crews with hand tools.

Provide a protective canopy to guard against tree branches. Use one and 1/2-ton trucks with protective canopies to haul up to 20 people with hand tools.

10-2.7.2 Equipment transport. For light and medium tractor-plov units, use commercial-type, single- or tandem-axle truck chassis in accordance with gross vehicle weight (GVW) requirements. Equip with a hydraulically operated, rear-platform ramp hoist and loading winch (fig. 10-13). For heavy tractor-plov units and bulldozers, use tractor trucks (usually five-ton, 6 X 6) with special high-low semitrailers or lowboys (fig. 10-14). Tilt-bed trailers may be desirable since they facilitate loading or unloading.



Figure 10-13 Loading a light tractor with fire plow attached



Figure 10-14. Fire-fighting equipment on transport truck with roll-back ramp.

10-2.7.3 Tank trucks and tractors. Use small four-wheel-drive trucks, equipped with fixed or slip-on tanks, to permit travel on unimproved roads and trails. These trucks are used chiefly for holding backfires and mopping up. Flatbed trucks may be used for transporting tanks of larger capacity. Crawler tankers for difficult terrain can be improvised by mounting two 50-gallon, rectangular tanks on carriers over the tracks of light crawler tractors. Equip tractors with pumps, bumpers, radiator guards, lights, and protective brush guards for the operator, tanks, and hose connections. Provide 50 feet of discharge hose in hose racks on the tank trucks.

10-2.7.4. Fire-line plows. Use tractor-plow units, rather than hand tools, for firebreaks wherever the terrain and soil depth permit. These plows are mobile, efficient, and economical. The hydraulically operated swivel-hitch plow, mounted on a light to medium crawler tractor, is the most common type. A heavier hydraulic or screw type unit usually consists of a two-disk plow, with coulter and plow-point mounted on aircraft type wheels for towing behind a heavy crawler tractor. Equip tractors with heavy

bumpers, radiator guards, rear winches, protective armor underneath, brush guards for the operators, and lights (front and rear). Design the bumpers to prevent saplings and poles from fouling the tracks. Use wide-track shoes on soft ground for maximum flotation. Provide a gravity-type safety hitch over the drop pin to prevent accidental disconnection between plow and tractor unit. Hydraulic lines should be spring rigged to override the hitch without bin- ding and be equipped with quick breakaway coupling. Provide a tool box on the back of the plow unit for storing long lengths of 3/8-inch chain. When working in wet areas, the chain can be used to facilitate movement of the tractor by hooking to the track and tying to trees or stumps.

10-1.7.4.1. On sandy soils, grass cover, light brush, and the like, use light plows (350 pounds) pulled by crawler tractors with 4,000 pounds minimum drawbar pull. Wheeled tractors, with or without auxiliary tracks, can be substituted where light ground cover exists. Transport with 1 1/2-ton trucks equipped with loading skids.

10-2.7.4.2. On loamy soils, especially in areas with longleaf, slash, loblolly, shortleaf, and ponderosa pine types and in average pine reproduction areas, use middleweight plows (500 pounds) pulled by crawler tractors with 8,000 pounds minimum drawbar pull. Transport these plows with semitrailers.

10-2.7.4.3. On clay or much soils, in areas with dense pine undergrowth and heavy underbrush, use heavy plows (1,000 pounds) pulled by crawler tractors with 10,000 or 15,000 pounds drawbar pull. A V-bar may be substituted for bulldozer blades on these units. Transport on lowbed or tilt-bed trailers. 10-2. 7.4.4. Consult the State or Private Forestry Office of the Forest Service (app. D, no. 3), or the state forester, for local equipment design recommendations.

10-2.7.5. Bulldozers. Since bulldozers are generally available on installations, they form a valuable reserve of equipment for building fire lines. The angledozer is better than the straight bulldozer for most sites. Equip units, where practical, with lights (front and back), protective armor underneath, winches, and shields for the operators. Powered road graders can also be used in light soils and light brush.

10-2.7.6. *Pumping equipment.* Portable pumps are used for filling truck tanks when a source of water is close to the fire, or for spraying on the fire if water supplies are

nearby. Power is supplied by two-cycle or four-cycle engines. The four-cycle engine requires less repair and is easier to start under difficult conditions. Both gear drive and centrifugal type pumps can be used. Use strainers on intake suction hoses operated in reservoirs and ponds where foreign matter is present. Information on pumping equipment supplies is available through GSA Supply Catalog OFFS-000-7. Additional information, including manufactures, can be obtained locally from the nearest U.S. Forest Service Office.

10-2.7.7. *Hand tools.* Forest and grass fire suppression hand tools in general use are indicated in figure 10-15. Guidelines for the selection of hand tools are contained in tables 10-2 and 10-3. Specialized fire tools for fighting wildland fires (e.g., lady shovels, and Pulaski tools) are available through GSA Federal Fire Suppression Equipment Supply Catalog OFFS-000-7. Keep fire tools sharp and handles tight; store them in accessible dry places. Inspect and recondition them after each use. Mark hand tools distinctly, store them in clearly designated locations, and use them only for fires.

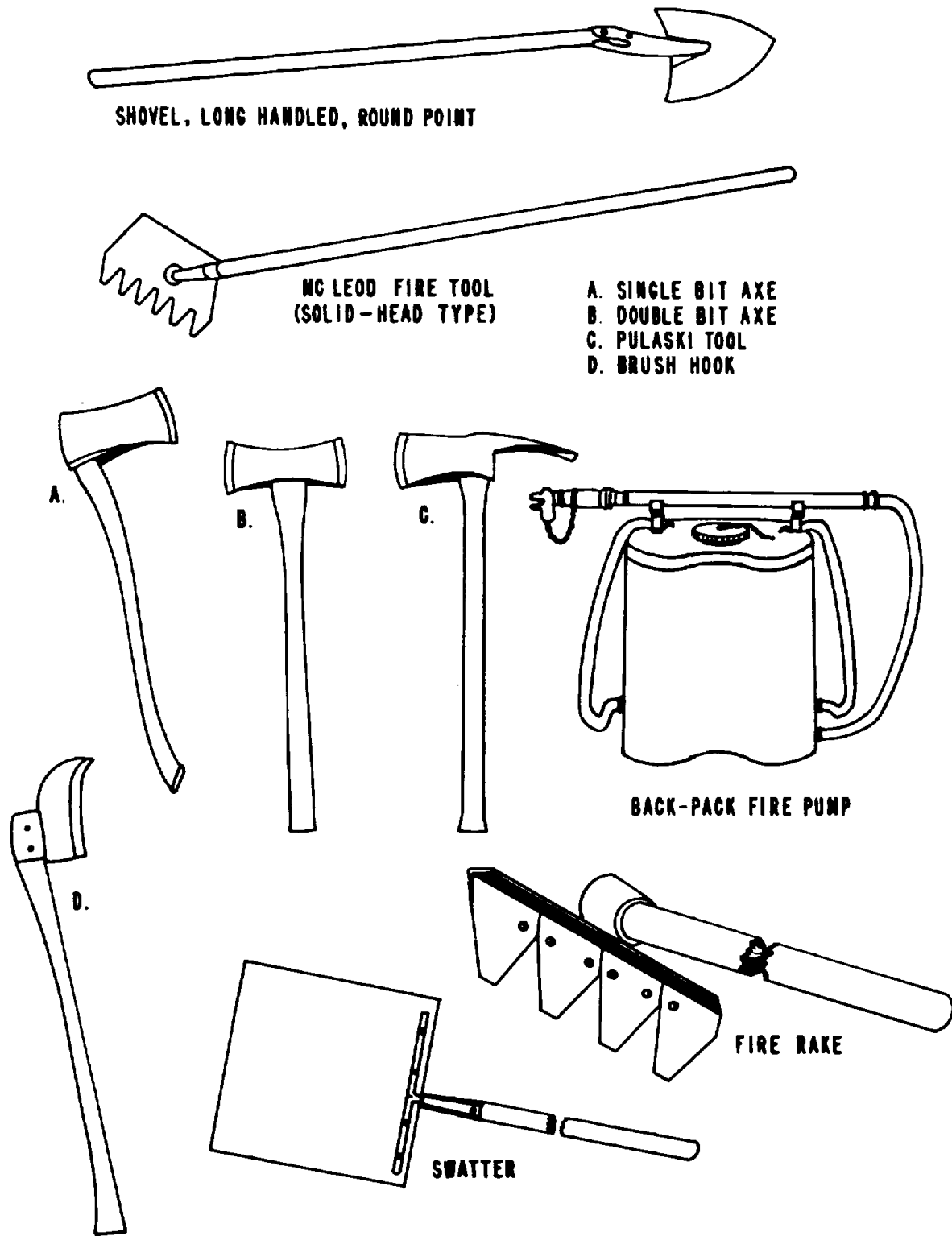

Figure 10-15. Hand tools in general use for forest and grass fire suppression.

Table 10-2 List of Fire Tools/Supplies for Use with Tractor-plow Units on Wildland Fires

Tools	Crew size		
	6	12	(Number of people 25)
Axes, double or single bit	1	2	4
Chain 3/8" (in long lengths) (2).....			
Chaps, chainsaw	1	1	1
Gloves, leather palm	6	12	25
Hats, hard	6	12	25
Hooks, brush	1	1	3
Lights, battery type	6	12	25
Pumps, backpack	2	4	8
Rakes, fire	2	4	8
Saws, crosscut or power	1	1	1
Shelter, fire (1).....			
Shovels, LHRP	1	2	6
Tool box (welded to back of plow unit)(3)			
Torches, drip	2	3	8

(1) 1 per individual if required by local conditions

(2) 2 per tractor-plow unit

(3) 1 per tractor-plow unit

Note: The number of tools may vary depending upon local requirement. At installations having a Forest Management Program, coordinate above requirement with appendix A, no. 3.

Table 10-3. List of Fire Tools/Supplies for Use by Handline Crews on Wildland Fires

Tools	Crew size		
	6	12	(Number of people 25)
Axes, double or single bit	1	2	4
Chaps, chainsaw	1	1	1
Gloves, leather palm	6	12	25
Hats, hard	6	12	25
Hooks, brush	1	2	4
Lights, battery type	6	12	25
Pumps, backpack	2	4	8
Rakes, fire	4	8	16
Saws, crosscut or power	1	1	1
Shelter, fire (1).....			
Shovels, LHRP	2	4	8
Swatters (2)	4	6	12
Torches, drip	1	1	2

(1) 1 per individual if required by local conditions

(2) Ordinarily for grass fuels.

Note: The number of tools may vary depending upon local requirement. At installations having a Forest Management Program, coordinate above requirement with appendix A, no. 3.

10-2.7.7.1. Ready tools should be stored in a central location from which attack forces start or placed in toolboxes at key points on the installation. Provide toolboxes with tools for 6, 12, or 24 people and so label. Use boxes which are weather-tight and mounted on truck-bed-height platforms for ready loading. Seal boxes with car seals; never lock them. Show the locations and quantities of tools stored in the fire protection plan.

10-2.7.7.2. Reserve tools should be stored in a central location.

10-2.7.8. Aerial equipment. A number of drop buckets should be kept available for helicopter use. Sizes will vary depending upon the capacity of available helicopters. The maximum size is the 1,000-gallon bucket which can be used by the Giant Chinook Helicopter (fig. 10-16). Information and assistance in training for use of helicopters in suppression of forest and grass fires may be obtained from Division of Cooperative Fire Protection, US Forest Service, 1720 Peachtree Road, NW, Atlanta, GA 30309. Air tankers

specially designed for fire fighting, particularly in the west, are maintained by various State forestry agencies, the Forest Service, and the Bureau of Land Management (app. D, no. 3 and 6). Their availability and use on installations should be covered in a fire suppression cooperative agreement. A liaison person, trained and proficient in air attack techniques, should be present at the fire. Positive communication with the aircraft is essential.

10-2.7.9. *Fire retardants.* Chemical fire retardants can be applied by ground tankers, air drops by fixed-wing planes, and helicopters. Only the fire retardants approved by the U.S. Forest Service should be used. For chaparral and grass areas of the South-west and West, use high-viscosity retardants; for ground fires with deep fuels, such as in Alaska, use low-viscosity retardants with a wetting agent added. Chemicals are further discussed in Chemicals for Forest Fire Fighting (app. E, no. 3).



Figure 10-16. Testing water bucket of chinook helicopter.

10-2.8. *Manpower.* Each installation should analyze its personnel needs depending upon the size of the installation, its fire history, and the types and availability of fire-fighting equipment. Use forestry personnel, when available, or trained building and grounds crews as primary sources. The fire protection plan should include

an augmentation plan that spells out the use of supplemental assistance from enlisted military and installation civilian personnel. The plan should cover a situation where once suppression of a fire is beyond the capability of the installation forces and equipment, immediate communication can be established with other

federal or state agencies to procure specialized equipment and/or highly qualified personnel to take charge of the fire. Many installations now have such agreements and are provided aerial water drops and highly trained wildland firefighters on call. This is especially true on installations located in the western part of the U.S. where high hazard conditions result in extremely complex fire problems. Arrangements for assistance from these non-military sources may be accomplished by initiating an "Agreement for Fire Suppression Service and Equipment" (app. F) and/or "Cooperative Agreement" (app. G). Assistance in preparing agreements may be obtained from higher headquarters or by contacting FIREBASE Operations Center, Boise Interagency Fire Center, 3905 Vista Ave., Boise, ID, 83705. Telephone (208) 384-9457 or FTS 554-9457.

10-2.9. Field training units. Dispatch tools or equipment, as necessary, to field training units since many fires originate from such training activities. Storage houses at firing ranges should be equipped with handtools. The initial attack should be accomplished by field units. A fire protection SOP should be made available to all field commanders.

10-2.10. Fire Protection Plan. A fire protection plan is required for installations which: contain a minimum of 500 acres of improved, semi-improved, and unimproved land; contain 100 or more acres of commercial forest land; or have a need indicated by local appraisal. (A suggested outline for the plan is at app. H).

10-2.11. Cooperative Agreements. A fire detection and suppression agreement should be made with the appropriate state forestry organization, the Forest Service, the Bureau of Land Management, National Park Service or Bureau of Indian Affairs, as applicable.

10-2.12. National Fire Danger Rating System (NF- DRS). Fire danger rating is a standardized system of informing fire control personnel how severe fire conditions are. This system converts observed and forecasted weather data into fire behavior indexes. Fire behavior characteristics include rate of spread, energy release, occurrence, probability of ignition, and flame length. Fuel models have been devised as a means of organizing the required fuel information for input into a mathematical model. At present, there are 20 fuel models identified, each varying in the amount, size, and arrangement of fuel available. These models have applications for specific timber types and vegetative covers for various parts of the country. Fire danger indexes determined by

the NF- DRS are available to all installations through cooperation with state and federal agencies. Fire danger stations to gather and provide weather measurements may be justified on installations larger than 25,000 acres. The Fire-Weather Observers' Handbook (app. E, no. 3) is an excellent guide to the operation of a fire danger station. In addition to daily weather observations, other subjective evaluations must be made by fire control management, as discussed in National Fire Danger Rating-1978: Use and Interpretation (app. E, no. 3). See Agricultural Handbook 360, "Fire Weather" available from Superintendent of Documents, Government Printing Office, WASH DC 20402.

10-3. Fire Suppression (See app. F for "Sample Agreement For Fire Suppression Service and Equipment".)

10-3.1. Suppression Principles. Fire suppression includes locating and reporting the fire, transporting personnel and equipment, containing and extinguishing the fire, and mopping up to make certain the fire is out. Fire is a rapid, chemical combination of oxygen, heat, and fuel (fig. 10-17). Suppression is accomplished by altering or revising one or more of these elements (fig. 10-18). To cut off oxygen, smother or beat out the flames. To reduce temperature, cool by applying water or soil and by separating the burning fuel from the unburned fuel. To remove or cut off the fuel supply, make a barrier around the fire. Stop the fastest moving part of the fire first.

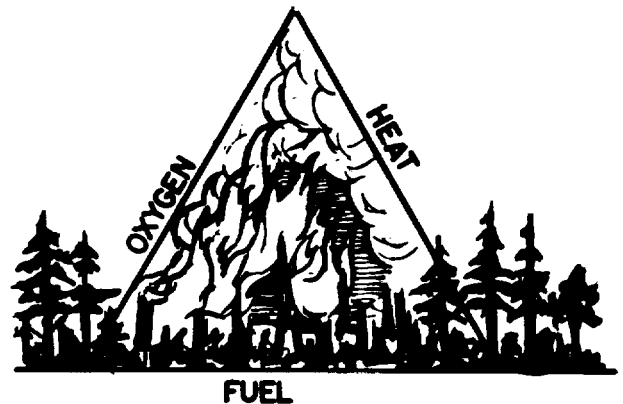

Figure 10-17. The fire triangle.

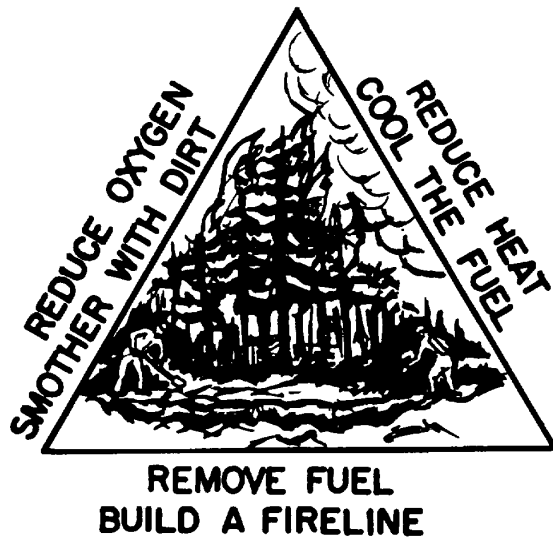

Figure 10-18. Breaking the fire triangle.

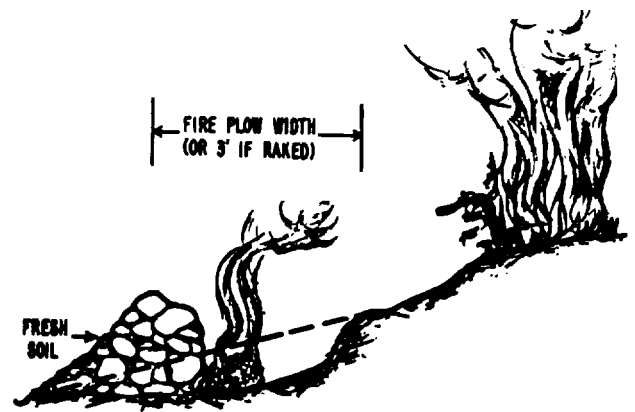

Figure 10-19. Hillside fire-line construction designed to stop rolling embers.

10-3.1.1. *Characteristics of forest, brush, and grass fires.* Forest, brush, and grass fires have characteristics which materially influence their suppression.

10-3.1.1.1. *Variety of fuels.* Vegetative fuels include dry grass, standing timber, dense brush, limbs, tree tops, leaves, needles, deep duff, peat, dead roots, and stumps. These fuels may burn for many days, some underground, and break out later to start new fires.

10-3.1.1.2. *Convection columns.* Vertical air columns develop where extensive areas of heavy fuel exist. Whirlwinds, blowups, crowning, and long-distance spotting can occur under these conditions. It is important that all fires be extinguished before they cover large areas.

10-3.1.2. *Safety precautions.*

10-3.1.2.1. *Stay alert.* Plan the attack and know where the fire is. Continually plan escape routes to assure personnel safety. Remember, the suppressed, quiet-appearing fire may be dangerous. For escape, use burned-over areas, streams, or gravel bars where available. Do not move personnel ahead of a fire. If it is necessary to jump through a fire, be sure the personnel cover their faces with hats or coats. After reaching an escape spot, dig foxholes, if necessary, and post a lookout for rolling logs or falling snags. Watch for rolling embers on hillsides (fig. 10-19). Make the personnel stay close to the earth and keep damp cloths over their faces to prevent suffocation.

10-3.1.2.2. *Work as a team.* Keep the crew together. When making an escape, retain all hand tools and move as a unit.

10-3.1.3. *Fire tactics.* There are two general methods of fighting fire: direct and indirect. In the direct method, the fire line is constructed, either by hand tools or machinery, at the edge of the fire. When the fire is extremely small, the edge can be worked simultaneously with direct attack on the flames by beating or using water. The direct method keeps the fire and damage within a minimum area and results in more rapid and positive control of the fire. The indirect method involves the reinforcement of a fire line by burning out the fuel between the line and the edge of the fire; this is called backfiring or burning out. The indirect method is best used on large, hot fires and when the fire danger rating (BI) so indicates. The details of fire tactics should be varied according to the fuel, topography, wind, humidity, and availability of personnel and equipment. The following basic tactics are normally applicable.

10-3.1.3.1. *Small fires.* If fuel is light and water is available from tankers or backpacks, use a direct attack on the head of the fire from inside the burn (fig. 10-20). On stronger fires attack the head of the fire first from outside the burn; then secure the flanks and rear. In making the line, use the most efficient tools available (e.g., hand tools, fire plow, and bulldozer). Make the shortest line possible; avoid sharp angles and pronounced crooks. Develop the line 2 to 6 feet wide. Chop out and remove all logs, snags, or roots. A mixture of water and fire retardant, such as bentonite, cascaded by Navy torpedo bombers converted to carry special 400-gallon tanks has been successful in holding, cooling,

and knocking down spot fires and in laying a line in advance of a fire. Lightweight bags with fire retardant and water mixtures can be used from helicopters. The

use of tankers and helicopters should be coordinated with suppression ground crews.

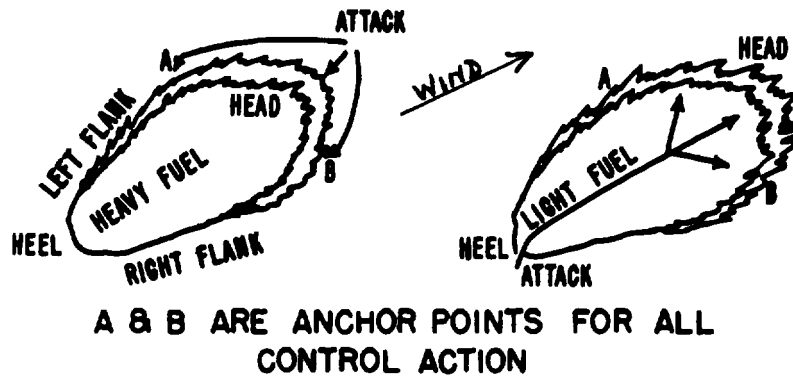

Figure 10-20. Small-fire tactics.

10-3.1.3.2. Large fires. Use tractor-plow or bulldozer units as described below.

10-3.1.3.2.1. One tractor-plow or bulldozer unit (fig. 10-21). Move tractor-plow unit from unloading point to anchor point A without plowing. Plow a control line (anchor points A to B) as close to the fire as possible. Immediately double back to point A, plowing a safety line 6 to 10 feet from the original line and checking for

breakovers. When the head fire is controlled, plow flanks A to C, then C to B. This action can normally be accomplished by the tractor operator. Under more severe burning conditions, a crew of three is desirable; the first person plows the line, the second follows the plow and sets the back-fire, and the third uses a backpack pump, shovel, or rake to control the backfire.

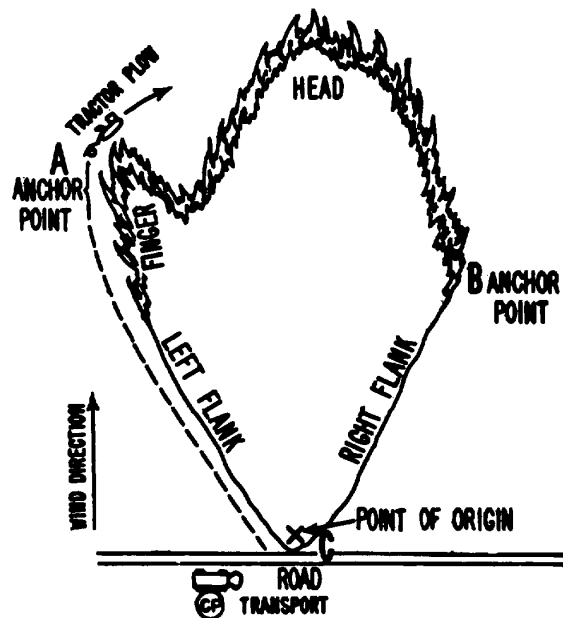

Figure 10-21. Tactics when only one tractor-plow unit is available.

10-3.1.3.2.2. Two tractor-plow units (figs. 10-22 and 10-23). Tactics are similar to those described in 10-3.1.3.2.1. above. The second tractor-plow is used to plow a safety line from anchor point A to B, or to move in from the right flank, depending upon the terrain and size of fire. Use a crew of three people with each plow as described in 10-3.1.3.2.1 above.

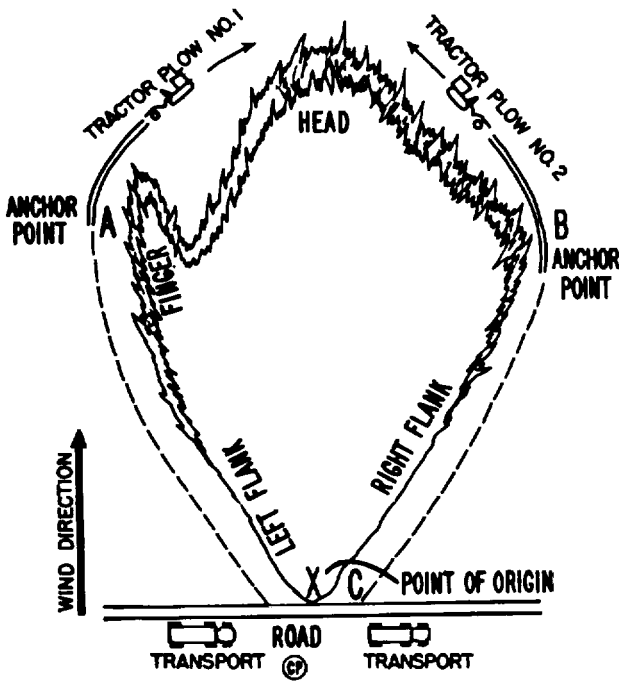

Figure 10-22 Tactics when two tractor-plow units are available.

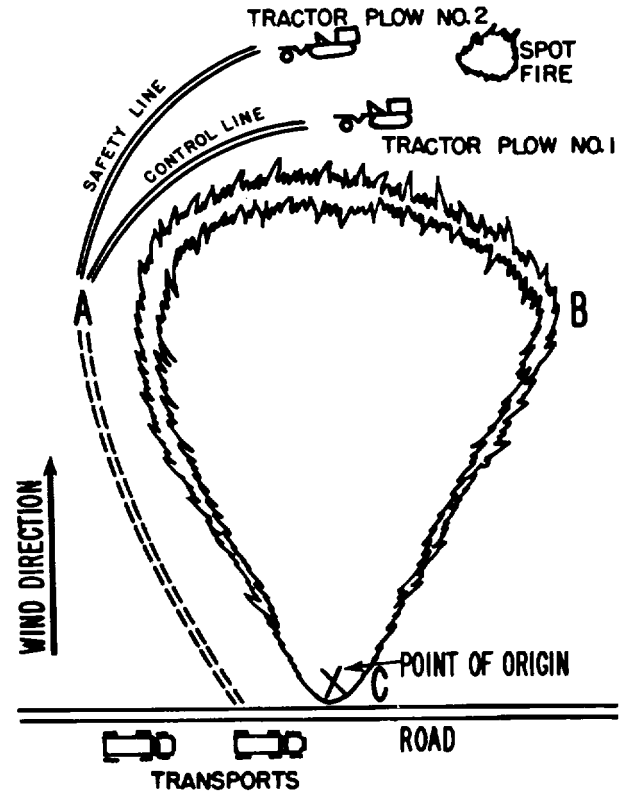

Figure 10-23. Alternate tactics for use of two tractor-plow units.

10-3.1.3.2.3. Hand tools without tractor-plows (fig. 10-24). Personnel and equipment should proceed ahead of the fire from anchor point A to B in the following

sequence: the line locator and line cutters with axes, brush hooks, and power saws; the line rankers with rakes, Pulaski tools, hoes, and mattocks; the backfiring person, and the line-holding unit with backpack pumps, rakes, and shovels. The line-cutting unit normally clears an area 6 to 8 feet in width of tall grass, brush, logs, and other debris. The line-raking unit develops a line approximately 2 feet in width. The line should be located far enough ahead of the fire to protect the crews from heat and smoke. Good linemaking requires coordination

of each function. Each individual removes only part of the material on the ground with one or two strokes and then moves forward. The last individual in the line, preceding the backfiring person, should thus reach mineral soil. The crew boss stays just behind the backfiring person to inspect the line and to control the rate of line firing. The line-holding unit protects the backfire and controls spot fires. A tank truck is useful to the line-holding unit. When the headfire is under control, the flanks should be attacked in the same way.

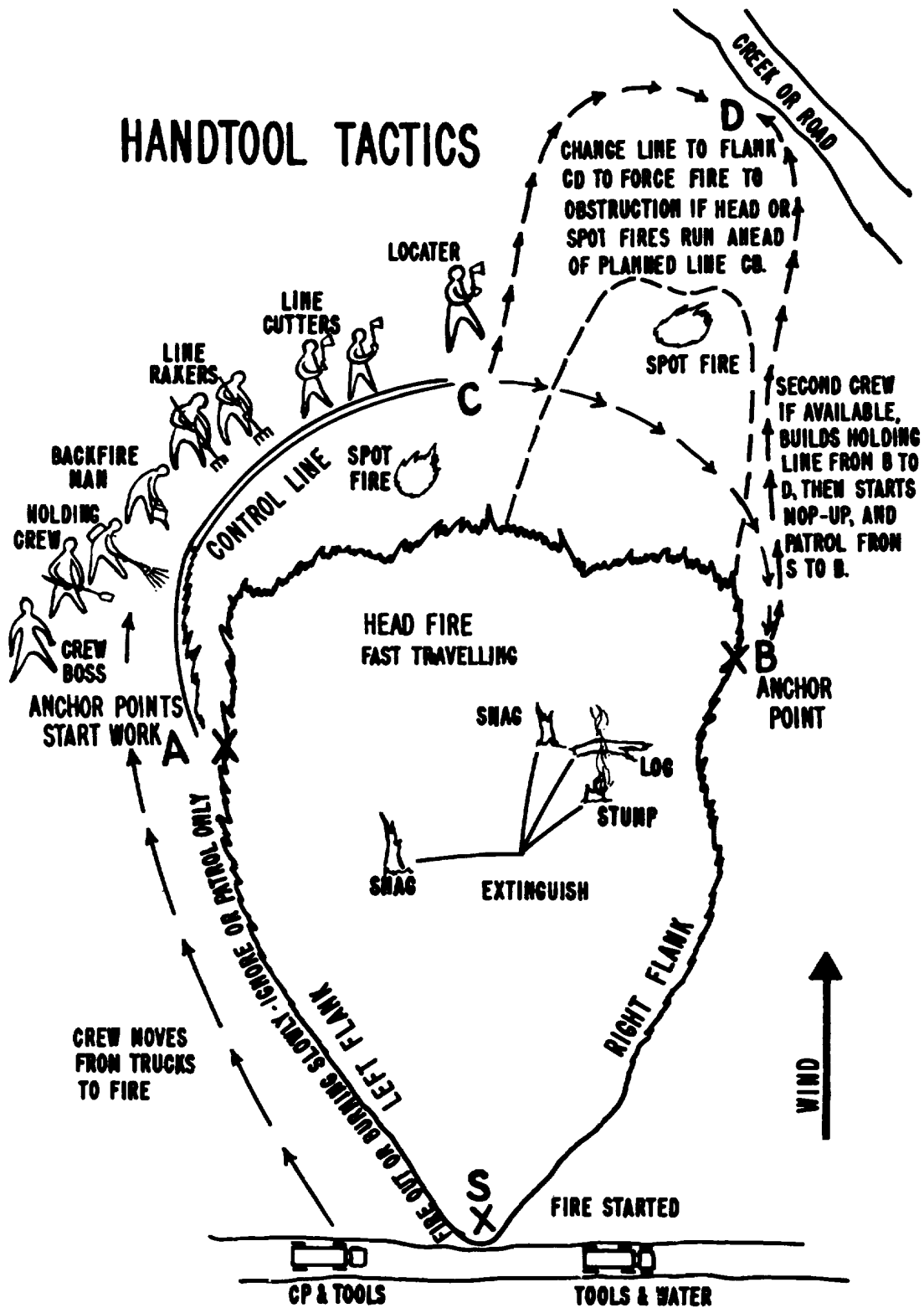

Figure 10-24. Hand tool tactics.

10-3.1.3.3. Grass and chaparral fires. Grass and chaparral fires should be attacked directly with tankers, pumpers, aerial bombardment, and hand tools. Avoid the use of heavy equipment on light and fragile soils in order to prevent eventual erosion. On large brush fires, use the cold-trailing technique which consists of directly attacking the fire's edge when the fire, because of changes in terrain, fuel continuity, weather, and wind, dies down in a significant portion of the fire perimeter.

10-3.1.3.4. Backfiring (indirect method) (fig. 10-25). Backfiring is one of the most useful methods available but is dangerous if used by untrained personnel. The

procedure consists of setting fire along the inner edge of a control line to burn into the wind and toward the headfire. Foresters' fuses and drip torches are available for this purpose. A good back- fire burns out the fuel in front of the headfire in time to prevent sparks from being thrown across the prepared line where the two fires meet. Areas burned by backfiring should be patrolled to insure against breakout if the wind changes. The location of all suppression personnel should be known, if possible, prior to backfiring.

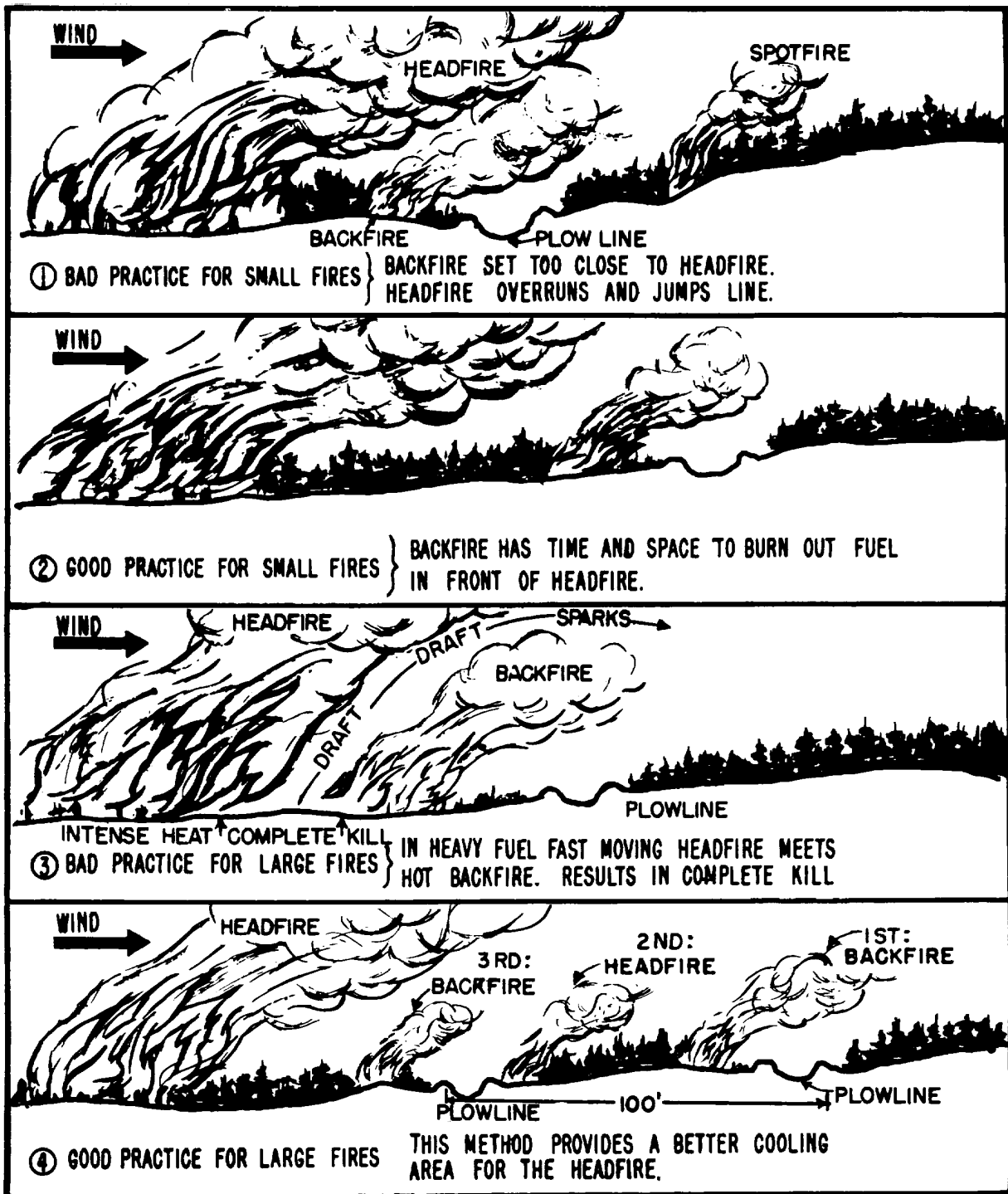

Figure 10-25. Good and bad backfiring.

10-3.2. Aerial Attack. Aerial support of ground fire-fighting forces involves reconnaissance, transport of fire fighters and supplies, and water and chemical drops. Aerial support should be used whenever possible. Water drops from helicopters onto small fires are very effective where water is readily available. Helicopter drops should be used on spot fires (fire spotting in advance of the main fire). On large fires, use chemical retardant drops by helicopter or fixed-wing plane. The chemicals should be dropped on the fuel in advance of the fire head. Never drop chemicals directly on the fire. Retardant drops can also be used to reinforce constructed fire lines wherever necessary. Aerial attack should be considered as support and not as complete suppression. Ground follow-up or mop-up is necessary before a fire can be considered controlled or out.

10-3.3. Mopup. When a fire is completely contained by a fire line, it is considered under control. The next step is the mop-up. On small fires, the mop-up should continue until the fire is completely out. Use water, sometimes mixed with mineral soil, to extinguish all smoldering fire within the fire line. On large fires, mop-up in the burned area should be concentrated near the perimeter of the fire. Patrols should be maintained during the entire mop-up operation to guard against flare-ups and to extinguish all previously undiscovered spot fires outside the perimeter. In the Southeast where tractor-plow units are used for suppression, mop-up can be held to a minimum by plowing a safety line around the perimeter of the fire and well beyond fall line of snags, with backfire as necessary. Lookouts can observe the area and report breakovers, thus saving valuable training time.

10-4. Fire Reports. Accurate records and damage appraisals of fires are essential to a planning and management program. Included in the record should be location, date and time the fire was first observed and by whom, time control operations were completed, method of suppression, number of fire fighters, type of vegetation and acreage burned, the fire danger rating index, cause or probable cause, and estimated value of damage.

10-4.1. Preparing Reports. Fire reports should be prepared as required by applicable military instructions and directives (app. A, no. 12). A sample report for woodland or grassland fires, utilizing DA Form 3985, is at app. I. (For Air Force, use AF Form 278.) Maintain a fire

location map by fiscal year, outlining the approximate area burned. Fire record information in paragraph 10-4 above is of particular importance where property of others is damaged and the military installation may be held liable. Fire reports should be analyzed at least annually to determine the effectiveness of the present fire protection plan. As a result of this analysis, corrections can be made in future fire plans.

10-4.2. Analyzing Damage. Damage to marketable timber; immature timber, areas having unmerchantable tree species, brush, or grass not utilized for grazing, and areas utilized for grazing, should be computed separately. All timber damage, whether mature or immature, should be determined by a proper timber inventory method (app. A, no. 3). Marketable timber should be appraised according to its volume and market stumpage values. Immature timber value should be based on reforestation costs, including site preparation, if necessary, and value of growth to present age. For example, average growth of southern pine is usually one to one and one-half standard cords per acre per year. To obtain monetary value of growth for an immature stand to present age (considering degree of stocking), multiply local growth per acre per year times age, times current stumpage prices. Areas within a burn which consist of unmerchantable tree species, brush, or grass not utilized for grazing should be appraised at three dollars (\$3.00) per acre for site deterioration. Where reestablishment of vegetative cover is required the appraised damage will be the cost of reestablishment. Costs in some instances, e.g. where soil erosion (wind or water) is a serious problem, could be quite high. Damage to rangeland should be computed by determining the loss of grazing capacity over the period necessary for the reestablishment of the vegetation. Values should be based on the annual average grazing fees in the area. Contact the nearest office of the Soil Conservation Service, Forest Service, or Bureau of Land Management (app. D, nos. 1,3,5) for grazing fee information and for vegetation reestablishment costs. Where fire damage extends to private lands, and possible litigation may result, a professional expert familiar with local conditions should be obtained to appraise damage.

CHAPTER 11. VEGETATION CONTROL

11-1. Weed Types and Situations.

11-1.1. There are many thousands of plants which become weeds when they occur on areas where they are not desired. Any plant becomes a weed when it crowds out desirable plants or becomes a fire or health hazard. For obvious reasons, methods cannot be described herein to control all undesirable plants. The control methods described attempt to cover only representatives of the various weed types ordinarily encountered. Weed types recognized by their growth and reproduction habits are annuals, biennials and perennials.

11-1.1.1. Annuals are plants that mature in one season and are propagated by seed. Foxtail (*Setaria spp.*), crabgrass (*Digitaria spp.*), common ragweed (*Ambrosia artemisiaefolia*), wild buckwheat (*Fagopyrum spp.*), and several mustards (*Brassica spp.*) are examples. A variation of the true annual is the winter annual, which germinates in the fall, lives over winter, and matures early the next season. Some plants of pennycress (*Thlaspi arvense*), common chickweed (*Stellaria media*), corncockle (*Agrostemma githago*), and shepherdspurse (*Capsella bursapastoris*) behave as winter annuals. The capacity of individual plants to produce thousands or, in some instances, hundreds of thousands of seeds that may shatter to the ground, provides an enormous source of new plants the following season. Many of these seeds remain viable for years when they are buried in the soil. The prolific production of seed, the buildup of weed-seed populations in the soil, and the length of time seeds remain viable in the soil are nature's way of insuring that annual weeds will be perpetuated. It is these properties of annual weeds that make eradication almost impossible. If the topgrowth is killed before seed is produced, the life cycle of that plant is ended, since it cannot recover. However, the reservoir of seeds in the soil may produce new plants for many years.

11-1.1.2. Biennials require two seasons to complete the reproduction cycle. Their growth period is longer than that of winter annuals. Since they are propagated by seed only, seedlings can be treated similar to those of annuals. Burdock (*Arctium spp.*), evening-primrose (*Oenothera biennis*), and common mullein (*Verbascum thapsus*) are examples of biennials.

11-1.1.3. Perennials are plants that live more than 2 years. Not only do they produce seed but many have additional means of perpetuation; they are provided with storage organs in the form of stolons (prostrate stems),

rhizomes (underground stems), bulbs, crowns, and roots. Supplies of food are stored in these organs by the plant to feed new growth the next year. The new shoot comes from a bud and lives on stored food until it becomes established. Unlike the annual plant, the topgrowth of a perennial may be killed and still the plant can live and propagate itself because of its storage organs. To control this vegetative reproduction, the food reserves must be materially reduced or the storage organs destroyed. The food stored by the plant is the excess manufactured by the green leaves and stems over and above what is necessary for growth; therefore, if photosynthesis can be prevented, the buildup of reserves will be curbed. For control of perennials, the new growth is allowed to draw on food reserves until it becomes sufficiently established to manufacture its own food and then the topgrowth is killed. Quackgrass (*Agropyron repens*), Canada thistle (*Cirsium arvense*), Johnsongrass (*Sorghum halepense*), buttercup (*Ranunculus spp.*), and nutsedge (*Cyperus spp.*) are perennials.

11-1.2. Weed situations, or problem areas, may be grouped as follows:

11-1.2.1. *Fire and security protection.* In this group are herbaceous plants which become flammable when mature or grow on sites which must be cleared for security purposes. Typical sites are equipment storage areas; railroad ballast; transformer cages; gas metering enclosures; some firebreaks; and areas near fire hydrants, trestles, bridges, and security fences. In most situations long-lasting herbicides are preferred. When soil sterilants are applied to these sites, due consideration must be given to potential erosion after treatment, runoff contamination of potable water reservoirs, and possible injury to desirable plants in adjacent areas through roots which grow into treated areas.

11-1.2.2. *Trees (other than forest management areas), shrubs and vines.* In this group are woody plants which must be removed for various reasons, principally clearing of firing ranges and rights-of-way, selective control on fence lines, and removal of thorny or poisonous plants which interfere with troop training. In

most situations selective type herbicides are used thereby retaining herbaceous type plants.

11-1.2.3. Forest management areas. For vegetation control specific to forest management see Forest Management Manual (app. A, no. 3).

11-1.2.4. Poisonous and noxious plants. In this group are plants toxic to humans or animals (see chap. 14, Safety), and noxious plants such as Canada thistle (*Cirsium arvense*), Russian thistle (*Salsola Kali*), Johnsongrass (*Sorghum halepense*) and Halogeton (*Halogeton glomeratus*). Installation land managers should be familiar with plants identified by the state as noxious and with the laws relating to control thereof.

11-1.2.5. Weeds in turf. In this group are those herbaceous plants which occur in areas established to grass and which must be removed to improve the appearance of the site, provide more economical maintenance, and develop a dense turf. Typical sites are lawns, parade grounds, ball fields, and golf courses. Before treatment is determined, plants which are to be eradicated should be identified and evaluated. Management practices are equally as important as herbicides. Certain weed species are able to invade a dense turf during the dormant stage of growth, but weed infestation is commonly the result and not the cause of poor turf, and control of weeds does not result in better turf unless conditions causing poor turf are corrected. (See para. 11-2 for cultural practices.)

11-1.2.6. Aquatic and marsh weeds. In this group are plants that choke drainage ditches, ponds, and streams, or are inaccessible to tractor-operated mowers because of swampy terrain. Typical species, type of plant, and herbicides to use are included in the Herbicide Manual for Noncropland Weeds (app. A, no. 11). There are three types of aquatic plants: **11-1.2.6.1.** Submerged plants which are controlled by applying herbicides to the water surface or injected below the surface. Some plants in this group are rooted in the soil; others, such as most algae, are not rooted.

11-1.2.6.2. Floating plants, both rooted and nonrooted, which are controlled by applying herbicides to the exposed plant parts.

11-1.2.6.3. Marsh plants, usually along shore lines or in swamps. Special caution must be taken for herbicide control of weeds on aquatic and marshland sites because the application may involve: potable water resources; irrigation water for sensitive crops; and toxicity to particular forms of fish and wildlife. Herbicides for treatment of reservoirs and canals carrying water for potable use must have approval of the Surgeon General.

Herbicides used for weed control in irrigation channels must not be toxic to sensitive crops. Herbicides for control of pond and lake weeds must not be toxic to fish and wildlife. Swampy areas covered by undesirable vegetation can often be satisfactorily controlled during periods of low water level by tractor mowing.

11-1.2.7. Weed control in or under paved areas. Vegetation that encroaches from the edge of concrete or asphalt pavement or grows up through cracks and holes can cause premature breakdown of the pavement. Control with presurface and post-surface applications of herbicides is possible. Shoulders immediately adjacent to roads, medians separating divided highways, and islands at intersections are often surfaced with asphalt. On such areas herbicides can be applied to the gravel base just before it is "shot" with asphalt. A standard highway watering truck can be adapted for this use by equipping it with a loading pump, to circulate the spray material, and standard asphalt nozzles that deliver a fan spray. In many cases, soil-active herbicides may be combined with the primer with as much effectiveness as applying them over the sub-base in a separate operation. Several herbicides prevent the emergence of plants through the pavement, but they vary in cost and in injury to vegetation adjacent to the paving. The plant growth on the unpaved area, particularly on fill slopes, may be desirable to prevent erosion. Postpaving treatments may be necessary later to prevent encroachment from unpaved areas and to control vegetation growing up through the cracks in old pavements. Soil sterilants, including diuron, monuron, TCA, and others (when in accordance with EPA requirements), may be used to prevent reinfestation. Care should be exercised to prevent damage to desirable vegetation and trees adjacent to treated areas.

11-2. Cultural Practices. There are numerous cultural practices which control vegetation or restrict its growth.

11-2.1. Mowing is probably the most common practice adaptable to improved and unimproved ground areas where the terrain is not too steep to preclude equipment operation. Timely mowing will prevent noxious weeds from going to seed; regulate the height of vegetation on firebreaks, rights-of-way, etc; and help to maintain a dense turf in improved ground areas.

11-2.2. Cultural practices common to turf maintenance other than mowing, are irrigation, aerification, and fertilization. When these practices are not properly performed vegetative growth is adversely affected.

11-2.3. Cultural practices adaptable to forest management areas are referred to as timber stand improvement (TSI). Included are cutting and, in most instances, the removal of undesirable trees; and prescribed burning in the southern pine areas to reduce forest floor litter, remove underbrush, and kill undesirable species or poor stems. For additional information see chapter 10.

11-3. Herbicides.

11-3.1. *General.* The Herbicide Manual for Non-cropland Weeds (app. A, no. 11) provides a thorough discussion and description of herbicides and their uses. The following supplemental information involves areas requiring intensive treatment: areas around trees and

shrubs in landscape plantings and areas which need edging and spot sterilization adjacent to walks, fire plugs, signs, fences, in parking lots, storage lots, and gravel blankets. See paragraph 14-4 for control of pesticides, container labels, safety rules, and current information.

11-3.1.1. *Tree and shrub areas.* Herbicides used in landscaped areas should be relatively nontoxic to trees, shrubs, and ground covers such as pachysandra, myrtle, English ivy, euonymus, and ajuga, and they should keep both annual and perennial weeds and grasses under control Tables 8 through 13 of the Herbicide Manual (app. A, no. 11) provide a comprehensive guide to the selection of appropriate herbicides for ornamental plantings. Effective herbicides for landscape planting are listed in table 11-1 to supplement the information in the Herbicide Manual.

Table 11-1. Effective Herbicides for Landscape Planting (Subject to EPA change)

Herbicide	Type	Time of application	Weeds controlled	Remarks
Amitrole	Systemic	Summer	All	
Casoron (Dichlobenil)	Systemic	Winter, preplant or pre-season	All	
Dalapon	Systemic	Summer	Grass	
Dacthal	Systemic	Summer	Grass	Injurious to Ajuga and tender perennials
Dowpon	Systemic	Summer	Grass	
Dymid	Systemic	Summer, preplant or in season	All	
Dicamba	Systemic	Summer	Brush	Woody plant killer
Methyl Bromide	Fumigant	Summer, preplant	All	
Paraquat	Contact	Summer	All	Hazardous to humans
Phenoxy Compound (2, 4-D)	Systemic	Summer	Broad Leaf	
Princep (Simazene)	Systemic	Spring, preemergence	All	Absorbed by roots
Phytar 560	Contact	Summer	All	
Round-Up	Systemic	Summer	All	
Sinox	Contact	Summer	All	Dinitro compound
Stoddard Solvent	Contact oil	Summer	Succulent weeds and grass	Used about evergreens, injurious to Ajuga and tender perennials
TCA	Systemic	Summer	Grass	
Treflan (Trifluralin)	Systemic	Spring/Summer, preplant	All	
Vapam	Fumigant	Summer, preplant	All	

11-3.1.1.1. Precautions. Both contact and systemic herbicides are used around woody plants and ground covers. However, caution should be taken to spray only unwanted weeds and grasses and not the foliage of landscape plants. Furthermore, selective herbicides which may be safe for many plants may be toxic to some species. For example, Dacthal is safe for most ground covers but toxic to ajuga. The phototoxicity warnings on pesticide container labels should be carefully observed. Herbicides commonly used to kill broadleaf weeds in turf are often toxic to woody plants. Among these are the phenoxy compound (2, 4-D) and Dicamba (Banvel D). These should not be used in tree and shrub areas. Also, soil sterilants, such as Atrazine, Borate Sodium Chlorate, Diuron (Karmex), Fenuron, and arsenical compounds, should not be used near landscape planting since they break down slowly and leave toxic residues in the soil. Boron compounds dehydrate the plants they kill so thoroughly that they create a fire hazard.

11-3.1.1.2. Preemergence and postemergence herbicides. Preemergence herbicides prevent the germination of weed and grass seed and root activity in tilled soil. Casoron (Dichlobenil) is fairly effective if applied in winter or early spring, although some injury to certain plants may occur. Princep (Simazene) is useful in early spring and Treflan (Trifluralin) during the growing season. Postemergence herbicides kill weeds and grasses in various stages of growth. Paraquat and

Phytar are useful contact substances; Amitrole, Dalapon, Dacthal, and Round-Up are useful systemics.

11-3.1.1.3. Herbicides in mulch. Mulch is a weed growth deterrent. Now, herbicides incorporated with wood chips and spread over the ground have been found effective in controlling weed and grass growth beneath trees and shrubs. The materials must be well mixed, as by a concrete mixer. Among the herbicides which have been used are Casoron, Princep, and Treflan, but the work in this area is still experimental. The use of herbicides in mulch on military installations is not recommended except in formal programed coordination with herbicide specialists from the appropriate state agriculture experiment station.

11-3.11.2. Edging and Spot Sterilization. Herbicides termed soil sterilants not only provide complete kill at application but also remain in the soil for varying periods of time during which they kill any introduced seeds or plants. Soil sterilants must be used with extreme caution in landscape planting since their transport in water runoff after rain or irrigation or their drift during application may result in injury to desirable plants. The more commonly used herbicides for edging and spot sterilization are listed in table 11-2.

Table 11-2 Effective Herbicides for Edging and Spot Sterilization (Subject to EPA change)

Herbicide	Time of application	Weeds controlled	Remarks
Amitrole Amitrole/Simazine mix	Early growth to first bloom When plants are growing rapidly	Annual grasses and broadleaf weeds Grasses and broadleaf weeds	Decomposes rapidly Decomposes slowly, lasts longer than Amitrole alone
AMS (Ammonium Sulfamate)	Early growth to first bloom	Woody plants, mixed grasses, and broad- leaf weeds	Decomposes at medium rate
Atrazine	Preemergence or before plants are 1-1 1/2 tall	Non-selective	Lasts at least one year; do not use in tree and shrub areas
Borate-Sodium Chlorate	In spring when weeds are small	Non-selective	Decomposes slowly; flammable; do not use in tree and shrub areas
Bromacil Dicamba	In spring when weeds are small Preemergence and foliar	Both grass and broadleaf weeds Wide range of broadleaf weeds and some brush species	Use higher rates for perennial weeds; do not use in tree and shrub areas
Diuron	Before period of adequate precipitation	General vegetation at higher rates	Lasts more than one season at higher rates; do not use in tree and shrub areas
Picloram	Vigorous spring growth	Annual and perennial broadleaf weeds	Persists for 3 years or more in some soils; avoid drift; do not use in tree and shrub areas
Simazine (Princep)		Seeds and seedlings	Should not be used around some woody plants; follow instructions on label
Sodium Chlorate	Avoid application before long, rainy period	Non-selective	Decomposes slowly, lasts 1 to 4 years; flammable, observe all precautions; do not use in tree and shrub areas
TCA	When rain can be expected	Non-selective	Effective on moist grasses; lasts 1 year or longer; do not use in tree and shrubs areas

11-4. Plant Growth Retardants.

11-4.1. *General.* The practical value of chemicals to regulate plant growth has been a subject of scientific research for several years. Some progress has been made, but as yet, the general use of chemicals to retard shoot growth and development cannot be recommended as a maintenance practice. The chemicals which have influenced growth retardation in a number of species are not closely related and affect plant tissue differently. Some chemicals act only locally on the tissues treated; others are systemic and are transported throughout the entire plant. No one chemical or group of chemicals can be considered outstanding with all species and varieties of plants. The plants which respond most readily to regulating chemicals are those held most closely under artificial control, such as rhododendrons, azaleas, and herbaceous flowering plants. In all likelihood, future experimentation will expand the list, but at present, general use in landscape maintenance does not seem practical.

11-4.2. *Potential Uses.* The potential uses of growth retardants in landscape maintenance include:

11-4.2.1. Retardation of normal tree and shrub growth in order to eliminate or decrease pruning and training requirements.

11-4.2.2. Development of more compact and shapely

plants by "chemical pinching" rather than by removing lateral buds and shoots by hand.

11-4.2.3. Inhibition of retardation of flowering and subsequent fruiting of certain plant species.

11-4.2.4. Acceleration or retardation of the growth phases of a plant from juvenility to maturity.

11-4.2.5. Reduction of the growth rate of grass in order to save mowing costs.

11-4.3. *Application.* Experimental methods of applying chemicals to retard growth have included: spraying the foliage with chemicals in solution; injecting the bark of the trunk; painting a band about the trunk; and treating the roots by soil application.

11-4.4. *Plant Response.* The variation in plant response to the same chemical may be caused by environmental factors as well as by genetic differences, including: species or variety of plant; condition of plant tissues at the time of application; season of the year (plants are usually more affected by chemicals when in active growth); temperature and relative humidity; concentration of the chemical, which, in turn, may vary with the season and the condition of the plant; and method of application.

CHAPTER 12.
EQUIPMENT

12-1. Requirements.

12-1.1. General. The selection, use, and maintenance of grounds maintenance equipment is important to all grounds maintenance programs. Good equipment, plus a well-rounded supply of materials, a well-equipped repair shop, and an efficient maintenance program, determine the difference between economical and efficiently-operated programs and costly and inefficient programs utilizing old and wornout equipment and

maintenance methods.

12-1.2. Kinds of Equipment. There is a wide variety of equipment on the market today, designed to make grounds maintenance faster, more efficient, and more economical. Table 12-1 provides guidelines for selecting equipment for specific jobs. (See Forest Management publication at app. A, no. 3, for equipment at installations accomplishing forest management.)

Table 12-1. Suggested List of Grounds Maintenance Equipment

Item	Description	Performance	Uses
Aerator; greens	Self-propelled, Engine-8 hp. Width-Cuts 24-in. swath. Tines-Hollow, tapered. Hydraulic lowering and raising. Weight-805 lbs.	Removes 36 cores every sq. ft. of turf. Holes spaced on 2-in. centers, 3 in. deep. Aerates 8,000 sq. ft. per hour.	Aerating golf greens.
Aerator; large areas contour	Overall width-8 ft. Aerating pattern-6 in. o.c. Tines-8 per wheel, 96 per set. Interchangeable with coring, slicing or open spoon tines. Aerating wheels-12 spaced at 6-in. intervals. Weight-1,530 lbs. Dragmat-12 ft. wide by 10 ft. long. Towed by tractor with hydraulic hook-up.	Operates at speeds up to 10 mph. and aerates 6-ft.-wide swath. Dragmat attachment breaks up cores and grooms grass in one operation.	Aerating turf on hilly and undulating slopes.
Aerator; large areas, level	Similar to above except can be pulled by tractor with 3-point hitch.	Similar to above.	Aerating large level areas such as athletic fields.
Sprayer;aerosol or fog	Typical machine equipped with self contained power source, tank for insecticides, means of breaking up the liquid into desired droplet size, and force to impart initial velocity of fog as it leaves machine. Can be either skid- or wheel-mounted.	Smallest units treat a few acres; the largest, several square miles. Net width of coverage usually 400 to 500 ft. max., depending upon wind movements which are necessary to carry the fog over the area.	Controlling adult mosquitoes in restricted areas such as picnic and camping grounds and ball parks.
Sprayer;hydraulic, truck-mounted	Can be mounted on pick-up truck. Convenient model weighs about 220 lbs. with 4-1/2 hp. engine and 11-gal. tank.	Covers more area with less chemical load and equipment; cuts handling costs; reduces air pollution; uses lower volume of material.	Spraying sediment-free sprays in the low-gallonage range at pressures under 100 lbs. Also spraying in concentrated areas.
Sprayer; hydraulic, trailer-mounted	Generally towed by any tractor. Equipped with 200-gal. tank, 7-hp. air-cooled engine, pump providing 10 gpm. at 500 psi., and 20-ft. 5-in. boom which folds to 7 ft. 8 in. Also available with 100-gal. capacity.	Performs many turf management application control requirements, including spraying large turf areas with insecticides and fungicides. Can also spray herbicides on turf areas.	Spraying large park areas, golf courses, and other areas with large expanses of turf. Also smoothing ice skating rink surfaces.

Table 12-1. Suggested List of Grounds Maintenance Equipment-Continued

Item	Description	Performance	Uses
Sprayer; hydraulic, skid model	Made in a wide range of sizes suitable for transporting in jeep, truck or trailer. Smallest is the estate or wheel-mounted sprayer with 15- to 50-gal. capacity; largest with 500-gal. (and up) capacity.	Excellently performs all kinds of insecticidal and herbicidal control.	Insect control and sanitary chemical operations; weed control on rights-of-way.
Mistblower; back-pack	Has small, portable power unit, producing a fine mist. Spray covers 40 ft. horizontally and 33 ft. vertically.	Covers up to 10 times faster than hydraulic sprayers.	Spraying small, concentrated areas up to 33 ft. in height.
Sprayer, Mistblower or Concentrate Sprayer	Smaller models usually mounted on wheelbarrow or cart chassis with high-velocity, low-volume blowers delivering about 5,000 cu. ft. per min. at over 150 mph. Larger models (usually mounted on skids for truck, trailer or boat) deliver from 5,000 to 25,000 cu. ft. per min. at velocities from 100 to 150 mph.	Effectively covers from 50 to several hundred feet, depending upon size of machine, terrain, density of foliage, and direction and velocity of wind. Requires less volume of water resulting in operating economies.	Treatment of shade trees and residual and larvicidal treatment of large areas.
Power Duster	Available models light enough to be mounted on small farm tractors. Also a back-pack duster weighing about 22 lbs.	Useful in areas inaccessible to larger equipment.	Control of turf insects, distribution of insecticide pellets for mosquito control and dusting ornamental plantings.
Seeder, Pulverizer and Spiker	Combination of smooth grader, pulverizer and aerator with seed and fertilizer box creates loose seed bed for good germination. Also ideal for over-seeding or re-seeding. Can be mounted on any tractor with 3-point hitch.	Saves time and money since it does variety of tasks. Prepares seed bed, fertilizes and seeds about 2 acres per hr.	Seeding both blrge and small areas such as housing areas, parks, golf courses, military installations.
Fertilizer Spreader	Available in several models from 24 in. wide to 20 ft. wide. Hydraulic or ground-drive, mounted units furnished with hydraulic shut-off and turn-on. Towed by any tractor with PTO.	At 5 miles per hr. a machine; 8 ft. wide covers 4 acres per hr. 10 ft. wide covers 5 acres per hr. 12 ft. wide covers 6 acres per hr. 14 ft. wide covers 7 acres per hr. 20 ft. wide covers 10 acres per hr.	Spreading granular chemicals, herbicides, insecticides, fungicides and nematocides; also fertilizers and seed on all types of turf areas, large and small, dependent upon size of spreader.
Power Rake and Slicer	Self-propelled, heavy-duty machine. Engine-4 cycle, 10 hp. Width-19 in. swath. 34-1/2 in. overall. Blades-1/16 in. straight blades on 1-1/2 in. spacing; 1132 and 1/8 in. thick blades also available. Flail blade reel available.	Operates even in hard soils. Cuts about 10,000 sq. ft. per hour up to 1-1/2 in. deep.	Vertical mowing for thatch removal.
Power Rake, Scarifier and Grader	Rake measurements: Max. working width--10 ft. Min. working width-7-1/2 ft. Size of teeth-5/16 by 1 by 28 in. No. of teeth-44 (coarse). 60 (fine). Weight-625 to 695 lbs. Can be mounted on tractor with 3-point hitch. All controls managed directly from tractor.	With this machine one operator on a tractor can break up soil, remove stones and debris, level, spread, and fine grade.	Entirely preparing a good seed bed.

Table 12-1. Suggested List of Grounds Maintenance Equipment-Continued

Item	Description	Performance	Uses
Hydroseeder	Engine-7-1/2 hp., air-cooled. Pump-Heavy-duty slurry pump. Hose-50 ft., 1-1/2 in. water. Capacity-250 gal, 100 lbs. granular solids charge. Weight-850 lbs. empty. 3,000 lbs. charged. Can be mounted on pick-up truck.	Covers one acre per 4 hrs. in one-man operation.	Seeding, fertilizing and fiber-mulching in areas, one acre or less.
Hydroseeder	Engine-12-1/2 hp., air-cooled. Pump-Heavy-duty slurry pump. Hose-Heavy-duty, 1-1/2 in., water. Capacity-500 gal, 300 lbs. granular solids charge. Weight-1,350 lbs. empty. 5,850 lbs. charged. Can be mounted on truck or trailer.	Covers one acre per 2 hrs. in one-man operation.	Seeding, fertilizing and fiber-mulching in areas, 1 to 5 acres.
Hydroseeder	Engine-30 hp., air-cooled, Pump-Centrifugal, 400 gpm. at 70 psi. Spray range-80 ft. max. 20 ft. min. Capacity-800 gal, 1,800 lbs. granular solids charge. Weight-2,659 lbs. empty. 11,150 lbs. charged. Can be mounted on truck or trailer.	Batch time from full to empty in less than 15 min. As a rule, requires 500 gal. of batch to cover one acre.	Seeding, fertilizing and fiber-mulching in areas, 5 to 20 acres.
Hydroseeder	Engine-68 hp., watercooled. Pump-Centrifugal 500 gpm. at 100 psi Spray Range-150 ft. max. Capacity-1,000 gals., 2,500 lbs. granular solids charge. Weight-3,750 lbs. empty. 14,000 lbs. charged. Can be mounted on flat bed; recommended truck C.A. is 84 in. min. with G.V.W. rating of 15,000 to 19,000 bs.	Covers 2 acres in 30 min. Full load can be sprayed in 30 min. at distances from 20 to 150 ft.	Seeding, fertilizing and fiber-mulching in areas, 10 to 20 acres.
Hydroseeder	Engine-120 hp., water-cooled Pump-Centrifugal, 900 gpm. at 110psi Spray Range-175 ft. max. 20 ft. min. 350 ft. with extension hoses on the level Capacity-1,500 gal, 5,000 lbs. granular solids charge. Weight-6,000 lbs. empty. 23,800 lbs. charged. Can be mounted direct on chassis; recommended truck C.A. is 114 in. with G.V.W. rating of 27,500 lbs.	Covers 3 acres per load in 20 min.	Seeding, fertilizing and fiber-mulching on steep slopes and large areas, 10 acres and up.

Table 12-1. Suggested List of Grounds Maintenance Equipment-Continued

Item	Description	Performance	Uses
Hydroseeder	Engine-151 hp., water-cooled. Pump-Centrifugal, 950 gpm. at 125 psi. Spray Range-200 ft. max. 20 ft. min. 350 ft with extension hoses on the level Capacity-2,500 gals., 9,000 lbs. granular charge. Weight-7,150 lbs. empty. 35,150 lbs. charged. Has double channel construction struction so can be mounted direct on chassis; recommended truck, with tandem axles, C.A. is 131 in. with G.V.W. rating of 40,000 lbs.	Covers 5 acres per load in 20 min. or less.	Seeding, fertilizing and fiber-mulching on steep slopes and large areas, 15 acres and up.
Mower; rotary, riding	Engine-16 hp. governed at 3,300 rpm., air-cooled. Ground speed-0 to 8.5 mph. Blades-3 to 25 in. long. Weight-780 lbs. prime mover. 180 lbs. cutting deck. Height of cut-1 to 4 in.	Mows up to 18 acres in 8 hr. day at 5 mph. (2.25 acres per hr.) in one-man operation. Low center of gravity over al four wide-tread wheels provides good stability and traction on even on hillsides.	Mowing turf areas with numerous obstacles. With optional equipment can be converted into leaf mulcher or snow remover.
Mower; rotary, riding	Engine-4 cycle, 19.8 hp. at 3,450 rpm., water-cooled. Ground speed-0 to 10 mph. Blades-3 to 25 in. long. Weight-1,240 lbs. prime mover. 400 lbs. cutting unit. Height of cut-1-1/2 to 6 in. Cutting unit-72 in. Completely enclosed cab with roll-over protection system.	Mows up to 20 acres in 6-1/2 hr.-day at 5 mph. (over 3 acres per hr.) Cuts under over-hangs and trims close.	Mowing large turf areas. Can be converted to leaf mulcher, V-plow for snow, rotary broom, or a 48-in., two-stage snow thrower.
Mower; rotary, walk-behind, self-propelled	Engine-6 hp. at 3,600 rpm. Ground speed-3 mph. at 2,800 rpm. Blade-25 in. long. Weight-149 lbs. Height of cut-1 to 4 in. Width of cut-25 in.	Mows up to 2.5 acres per hr.	Mowing small lawn areas with numerous obstacles.
Mower; rotary, hand-propelled	Engine-4 hp. at 2,800 rpm. Blade-21 in long. Weight-71 lbs. Height of cut- 1/2 to 3 in. Width of cut-21 in.	Mows up to 1.5 acres per hr.	Mowing small lawn areas adjacent to buildings.
Mower; reel walk-behind, self-propelled	Engine-3.5 hp. at 3,600 rpm. Ground speed-3.6 mph at 2,800 rpm. 4.6 mph. at 3,600 rpm. Tires/Wheels-6in., solid rubber. 2 drums on ball-bearings. Cutter type-single, 21-in. reel Height-190 lbs. Height of cut-1/8 to 11/16 in. Width of cut-21 in.	Mows 2 to 3 normal-size greens per hr.	Mowing small golf greens.

Table 12-1. Suggested List of Grounds Maintenance Equipment-Continued

Item	Description	Performance	Uses
Mower; reel rubber tired	Prime mover-any tractor with PTO. Standard drive-4:00 X 15 in. dia. laminated, puncture-proof tires. Fairway drive-3:50 X 12.5 in. dia. laminated, puncture-proof tire Height of cut-7/16 in. to 3 in Width of cut-30 in. per unit. 5 units-11 ft. 10 in. 7 units-16 ft. 6 in 9 units-21 ft. 2 in 11 units-25 ft 10 in.	Mows 40 to 130 acres per day, depending upon number of units used. Laminated tires provide good traction for aloe.	Mowing large open turf areas, where fine, smooth cut is desired.
Mower; hollow-roller drive	Prime mover-any tractor with PTO. Height of cut-7/16 in. to 3.5 in. Width of cut-30 in per unit. 3 gang-7 ft. 5 gang-11 ft. 6 in. 7 gang-16 ft 9 gang-21 ft.	Mows 40 to 130 acres per day, depending upon number of units used. Reduces small-mower and hand-trimming cleanup. Permits mowing close to flower and shrub beds and curbs	Mowing on soft or sandy soils and under wet weather conditions on large, open turf areas where fine, smooth cut is desired.
Mower; reel, riding	Mowing tractor with hydraulically controlled pattern of gang mowers. Engine-gas or diesel, 107 or 78 hp. respectively. Width of cut-30 in. per unit. 3 units-7 ft. 6 units-12 ft. 7 units-14 f 6 in 9 units-20 ft 11 units-26 ft Power Steering. Roll-over Protection System.	Mows swaths 30 in. to 18-1/2 ft. wide in one-man operation Mows up to 80 acres per day.	Mowing large, semi-formal and limited-care areas.
Mower; reel, riding	Engine prime mover)-14 hp. at 3,600 rpm Ground speed- First: 3.7 mph. Second: 7 mph. Rev: 3.7 mph. Tires-Three 18 X 9.60 X 8, 2-ply, pneumatic, tubeless. Cutter-type-Three 21-in. reels. Weight-1,080 lbs. Height of cut-3/16 to 111/6 in. Width of cut-59 in	Provides uniform cutting height, appearance and playing characteristics to each green. Cuts one acre in about 30 min. Available with interchangeable spiker or thatcher.	Mowing large golf greens.
Mower, sickle-bar	Height of cut-2-1/2 in. Can be mounted on tractor with PTO or hydraulic control and operated from tractor seat. Normal operation uses less than 1 hp. from tractor engine.	Mows through 136-dgree angular range: 90-degree vertical cut to 45 degrees below horizontal Cuts about 1.6 acres per hr.	Highway mowing on shoulders and slopes; mowing tall grasses for hay crops; trimming hedges.
Spreader, Top-Dresser con- and Fertilizer	Topdressing turf following Hopper capacity-11.3 cu. ft. Spread width-39 in. Spread thickness-adjustable up to 1/2 in. Weight-561 lbs. Dragmat-6-1/2 ft wide X 6 ft. long, optional	Engine4 cycle, 6-1/4 hp. sistency of material. Spreads up to 175 ft. per min.	Designed to spread almost any thatching operation; spreading sand over icy pavements.

Table 12-1. Suggested List of Grounds Maintenance Equipment-Continued

Item	Description	Performance	Uses								
Brush Chipper	Several models and sizes available. Engine-25 to 100 hp. Weight-1,000 lbs. Cutting capacity-7 in. max. Can be trailer-mounted, towed by any tractor or small truck.	Reduces brush and small trees to chips in minutes. Reduction of volume about 10 to 1. Average length of Material in ft. Production rate Per Hour <table style="margin-left: auto; margin-right: auto; border-collapse: collapse;"> <tr> <td style="border-top: 1px solid black; border-bottom: 1px solid black; padding: 2px 10px;">15</td> <td style="border-top: 1px solid black; border-bottom: 1px solid black; padding: 2px 10px;">231 cu. ft. 2.0 Tons</td> </tr> <tr> <td style="padding: 2px 10px;">20</td> <td style="padding: 2px 10px;">288 cu. ft. 2.5 Ton</td> </tr> <tr> <td style="padding: 2px 10px;">25</td> <td style="padding: 2px 10px;">249 cu. ft. 2.2 Tons</td> </tr> <tr> <td style="padding: 2px 10px;">30</td> <td style="padding: 2px 10px;">189 cu. ft. 1.6 Tons</td> </tr> </table>	15	231 cu. ft. 2.0 Tons	20	288 cu. ft. 2.5 Ton	25	249 cu. ft. 2.2 Tons	30	189 cu. ft. 1.6 Tons	Disposal from storm damage to trees and pruning operations. Chips useful for mulching. Ideal in areas where burning is banned by law.
15	231 cu. ft. 2.0 Tons										
20	288 cu. ft. 2.5 Ton										
25	249 cu. ft. 2.2 Tons										
30	189 cu. ft. 1.6 Tons										
Wood Chipper, total	Engine-190 hp. at 1,800 rpm. Length-16 ft. 6 in. Width-8 ft. Weight-11,700 lbs. Chipper-40 in. Loader Boom Reach-13 ft. Swing-90 degrees. Can be towed by 3/4-ton truck.	Disposes of an entire tree up to 12 in. in diameter. Hydraulically operated boom loader eliminates all hand work.	Environmentally sound clear-cutting operations in right-of-way clearing, land clearing for construction, and highway clearing.								
Shredder-Grinder	Engine-3 to 5 hp. Hopper capacity-9-1/2 in. X 30 in. to 36 in. Can be transported by truck.	Reduces all kinds of waste and friable materials to bits in minutes. Produces mulching or soil building material from disposal materials, including shrub and tree trimmings from 3/8 in. to 1-1/2 in. Handles up to 35 cu. yds. per hr. in one-man operation.	Preparing waste materials for compost, soil improvement, mulch and organic fertilizer.								
Sweeper	Engine-5 hp. Sweeping swath-48in. Col. hopper capacity-4 cu. ft. Length-54.5 in. Width-55 in. Height-32.5 in. Weight-270 lbs. Broom material-Polypropylene. Can be towed by any small tractor.	Cleans up trash, gravel, leaves, dirt and thatch in one-man operation	Sweeping lawns, sidewalks, parking lots, streets and warehouses.								
Sweeper	Prime mover must have minimum 14-to-17-gpm. pump operating off prime mover hydraulic system. Sweeping Swath-60 in. Hopper capacity-8.5 cu. ft. Weight-620 lbs. Gutter broom, sprinkler system and vacuum system optional Can be mounted in place of bucket on loaders 'or forklift trucks.	Cleans up to 130,000 sq. ft. per hr. in one-man operation. With two-brush sweeping action, picks up bottles, cans, paper cups, etc.	Sweeping sidewalks, driveways, parking lots, streets, warehouses, and loading docks.								
Ray-O-Vac Cleaner	Powered by PTO from prime mover at 540 rpm. Engine-20 hp. at 3,600 rpm., air-cooled. Hooper capacity-5-3/4 cu. yds., fully enclosed. Weight-2,160 lbs. Flex-tip reel hard surface brush and thatching reel optional.	Versatile turf rake and vacuum machine. Lifts litter off turf, cleans hard surfaces and renovates turf by removing thatch.	Maintaining large turf areas such as parade grounds and golf courses.								

Table 12-1. Suggested List of Grounds Maintenance Equipment-Continued

Item	Description	Performance	Uses
Power Mulcher, small	Engine-30 hp., air-cooled Length-13 ft. Weight-1,750 lbs. Can be mounted on truck or trailer. Asphalt adhesive systems optional	Spreads 4 tons of hay per hr., 20% higher for straw. ranges up to 60 ft. in still air.	Mulching medium-size areas and spreading tree seeds, sprigs, fertilizer, lime, and mists.
Power Mulcher, large	Engine-6 cylinder, water-cooled in- dustrial gas engine rated at 102 gross continuous BHP at 2,800 rpm. Length-15 ft Weight-3,600 lbs. Can be mounted on truck or trailer. Asphalt adhesive systems optional	Spreads 15 tons of hay per hr., 20% higher for straw. Ranges 85 ft to 95 ft in still air.	Mulching highway slopes, steep slopes and large, seeded areas.
Tree Spades	Several Models available. Hydraulically operated and capable of digging, moving and tran- splanting any tree or shrub up to 6 in in diameter. Can be mounted on trailer.	Digs, moves (to new location up to 2-1/2 miles round-trip) and plants average of thirty, 4in. diameter trees in 8-hr day, in one-man operation	Preserving trees and shrubs in construction areas, parks, highway beautification projects, and on golf courses.
Stump Cutter	Several models available. Hydraulically operated in a ver- tical, circular motion Engines-30 to 65 hp. Cutting width-50 in. to 72 in. Cutting depth-6 in. to 24 in. Weight-1,400 to 5,200 lbs. Can be mounted on trailer.	Removes any stump 6 in. to 24 in. below ground in minutes in one-man operation. Saves labor and material costs, and solves stump disposal problem.	Removing stumps close to fences, buildings, drive ways and curbs, without tearing up the surroun- ding landscape.
Stump Razor	Self-propelled and operated in a horizontal, rotary motion. Removes any stump standing 5 in or less above ground Engine-8 hp. at 3,500W rpm. Cutting range-Max. 5 in above ground to 6 in. below ground. Weight-107 lbs.	Removes stumps efficiently and economically in minutes in one- man operation	Same as above with added advantage of being small enough to move through tight places.
Chain Saw	Lightweight, portable power tool available in several sizes. Usually consists of 2 units: po- wer unit (usually an air-cooled, 2-cycle engine) and cutting unit.	Cuts wood up to 32 in. in dia- meter. Select a saw with cutting bar 2 in. longer than average diameter of wood to be cut.	Clearing trees and brush; cutting firewood, fence posts, wood ties and cur- bs; and removing storm damage to trees.
Tractor Backhoe loader	Loading bucket capacity-1-1/2 to 2 cu. yds. Backhoe bucket capacity-7 to 12 cu. ft	Performs well under most cir- cumstances. The handyman of power tools with a performance record of many years.	Digs ditches, loads and transports earth, levels and grades, backfills, etc.
Log Splitter	Available in several models. Some have own power source with 4-hp. gasoline engine and 2- stage hydraulic pump. Others designed for use on tractors with 3-point hitch hydraulic system (the economical choice if auxilliary hydraulic sys- tem is available).	Splits logs up to 52 in. in length in fast, economical time. Delivers a full 10 tons of split- ting force.	Making firewood for re- creation areas.

Table 12-1. Suggested List of Grounds Maintenance Equipment-Continued

Item	Description	Performance	Uses
York Rake	A riding tractor and York rake is combination that makes short work of many finish grading jobs. With addition of scarifier and grader blade, it becomes versatile, triple-duty tool. Can be mounted on tractor with 3-point hitch.	Rake and attachments do many jobs: grading, leveling and smoothing; removing stones and other debris; mulching and pulverizing soil; spreading top soil; distributing crushed stone, gravel or cinders.	Developing and preparing parking areas, driveways, etc, for paving, maintaining unpaved roads and parking areas; cutting ditches; preparing seed-beds; etc.
Power Post-hole Digger	Augers available in various sizes for normal and coarse soil condition. Digging depth-40 to 48 in. Auger can be mounted on tractor with 3-point hitch.	Makes digging holes easy and more economical trees and shrubs.	Digging holes for fence posts and for planting
Aerial Tower	Hydraulically powered. Booms travel travel up-and-out or down. All controls from bucket with one-hand control system. Work height max.-45 to 95 ft. Can be mounted on truck.	All aerial towers should meet "American National Standards for Vehicle-Mounted, Elevating and Rotating Work Platforms; ANSI A92.2-1969" as required by Williams-Steiger Occupational Safety and Health Act of 1970, Part 1910, Occupational Safety and Health Standards, Section 1910.67.	Trimming trees, maintaining lines and lighting, painting and all "overhead" work.
Sod Cutter	Available in several sizes: from 12- to 18-in. cut. Heavy-duty sod cutters cut sod into strips and roll it automatically. They come with either sulky roller attachment or walk-behind model Engine-10 to 13 hp. Weight-391 to 748 lbs.	Most efficient method for cutting sod. Small, powered sod cutters cut up to 135 ft. of sod per minute. Heavy-duty machines cut 1-1/4 to 1-1/2 acres of sod per day in one-man operation	Replacing sod in worn-out areas of large expanses of grass and controlling erosion.

12-1.3. Power Equipment.

12-1.3.1. *Repair or replace decisions.* The principal advantages of power equipment for grounds maintenance are the reductions in hand labor and maintenance costs. However, since good equipment is increasingly expensive, there is a tendency to try to "make do" with old or worn out equipment. Such a policy eventually nullifies past advantages. It then becomes necessary to justify a repair or replace decision to those responsible for authorizing capital investments. Many factors should be considered in justifying such a decision.

12-1.3.1.1. An estimated repair bill may be greater than the trade-in value of a machine.

12-1.3.1.2. New technology and equipment may make it uneconomical to operate a machine although the machine may have one or two more years of life remaining.

12-1.3.1.3. Management objectives should include lowest overall cost, maximum efficiency, a low level of maintenance, and available manpower.

12-1.3.1.4. Among human considerations are the machine's safety and reliability, comfort and ease of operation, ease of adjustment and service, efficiency,

and basic simplicity or complexity.

12-1.3.1.5. A "total cost" perspective indicates that the initial purchase price is only one of several economic factors which should be evaluated. Other economic factors include initial investment (less estimated trade-in value of the equipment), savings in operating costs per year, savings in labor costs per year, savings in maintenance costs per year, and savings due to the lower risk of downtime with a new machine.

12-1.3.2. *Payback period.* The payback period is a simple method of presenting and evaluating repair or replace decisions and first-time investment decisions. A payback period table can be prepared with factors from subparagraph 12-1.3.1.5. By assigning dollars to each of the first four factors, the number of years required to "pay back" the initial investment can be determined. As an example, table 12-2 is based on a 4-year-old riding mower with 4,500 hours of use. Assume that: the mower is worth \$300 as a trade-in; the estimated repairs amount to \$1800; a new mower costs \$4000; the economic life of the new unit will be 6 years; and the old unit will

need major repairs in 2 years. Table 12-2 indicates that it will take 2 years to save or return the dollars spent for

the new machine; in other words, the payback period for the initial investment in a new mower is 2 years.

Table 12-2. Payback Period

Dollars out	Year 1	Year 2	Year 3	Year 4	Year 5
Initial investment	4,000	0	0	0	0
Trade-in value	300				
Total out	3,700	0	0	0	0
Dollars out	Year 1	Year 2	Year 3	Year 4	Year 5
Operating cost savings (gas, oil)	300	500	700	800	900
Labor cost savings	300	400	400	400	400
Maintenance cost savings	1,800	400	400	400	400
Total in	2,400	1,300	1,500	1,600	1,700
Cumulative dollars saved	2,400	3,700	5,200	6,800	8,500

12-1.3.3. Mowing costs. Table 12-3 can aid in determining mowing costs. The following example shows how to use the table: What does it cost to mow one acre with a 22-inch push mower if a laborer is paid \$2.50 an

hour? Multiply \$2.50 by 2.6 (approximate mowing hours per acre). This equals \$6.50 as the direct labor cost of the work.

Table 12-3. Figuring Mowing Costs

Width of cut (inches)	Mowing speed (mph)	Push (P) or rider (R)	Approximate mowing hours/acre	Labor cost/hour	Labor cost/acre
19	2	P	3.1		
21	2	P	2.8		
22	2	P	2.6		
25	2	p	2.3		
28	2	p	2.0		
28	3	R	1.3		
30	2	P	1.8		
30	3	R	1.2		
36	2	P	1.5		
36	3	R	1.0		
56	3	R	.6		
56	4	R	.5		
68	3	R	.5		
68	4	R	.4		
75	3	R	.45		
75	4	R	.35		
84	3	R	.4		
84	4	R	.3		

12-2. Care of Equipment. (For Air Force, see AF 77-series regulations and manuals.)

12-2.1. General Maintenance. Maintenance designed to prevent costly breakdowns includes two basic activities: periodic inspection of equipment to uncover conditions which may lead to breakdowns or excessive depreciation, and upkeep to remedy such conditions while still in a minor stage. By following these two basic activities through regular lubrication, job planning, and scheduling of repairs, certain major returns can be expected: fewer breakdowns with a corresponding

decrease in production downtime; fewer large-scale or repetitive repairs; lower costs for simple repairs made before breakdowns (since less manpower, fewer skills, and fewer parts are needed); less overtime pay for ordinary adjustments and repairs; and less standby equipment. The best way to achieve preventive maintenance is through periodic inspection to discover and correct unsatisfactory conditions. Frequency of inspection depends upon the amount and degree of use and varies from one area to another. To establish a

frequency cycle, begin with an analysis of the equipment, based on such factors as age, condition, value, amount of use, safety requirements, number of hours or miles operated, and susceptibility to wear, damage, and loss of adjustment. All equipment manufacturers supply detailed maintenance procedures for their equipment. Operators and maintenance crews should strictly adhere to these procedures.

12-2.1.1. Maintenance programs. Most maintenance programs can be divided into three groups: routine upkeep, periodic inspections, and contingent work. The contingent work may be done at irregular intervals when equipment is down for other reasons. The more work which can be squeezed into this category, the fewer downtimes will be required.

12-2.1.1.1. Routine upkeep. Routine upkeep of motorized equipment includes such items as lubricating, changing oil, checking tires and batteries, washing, tuning-up, checking spark plugs and points, and inspecting brakes. If the operator finds any of these items deficient, he should report it to the main service garage. For safer and more efficient operation throughout the working season: check the oil level every time the machine is to be used; clean the air filter every 5 hours; change the oil according to the frequency and viscosity recommended by the manufacturer; keep the entire machine clean (clean engines run smoother, operate cooler, and last longer); and check all nuts and bolts frequently.

12-2.1.1.2. Periodic inspections. Periodic inspections should be made at the garage by trained personnel. During these inspections, each moving part of the equipment should be checked and wornout parts removed and replaced. Following inspection, equipment should be thoroughly cleaned and lubricated.

12-2.1.1.3. Contingent work. Contingent work consists of repairs for major breakdowns or general overhaul of the equipment. At this time, the equipment should be inspected as during a regular inspection period, with all wornout or broken parts removed and replaced.

12-2.1.2. Preventive maintenance. The best maintenance is preventive maintenance. A program of preventive maintenance reduces the number and extent of repairs, thereby extending considerably the life and use of the equipment. Preventive maintenance, in the long run, saves time and money.

12-2.1.2.1. Spare parts. Maintain an adequate stock of spare parts in order to avoid expensive delays when equipment is needed. At the end of each fiscal year, all equipment should be checked thoroughly to anticipate

equipment and spare parts requirements for the following year.

12-2.1.2.2. Operator training. An important factor in making preventive maintenance effective is the proper training of the driver or operator. Improper operation is a major factor in mechanical failures of motor vehicles. Carelessness can nullify all efforts at proper maintenance. Wherever practicable, assign a regular driver or operator to each piece of equipment and make him responsible for it.

12-2.2. Maintenance of Power Equipment.

12-2.2.1. Tractor battery care.

12-2.2.1.1. Liquid level. The most important factor in lengthening battery life in a tractor is keeping the liquid at the proper level. The liquid should be checked regularly; in most cases, once a week. Since the charging process has a tendency to evaporate water but not acid, more water must be added at intervals to maintain the correct level. Unless some of the solution is accidentally spilled, it is not necessary to add acid. Distilled water is best for use in batteries; next best is clean, soft water (i.e., without dissolved minerals). Most batteries have some sort of marker to indicate the proper liquid level. Do not fill above this mark, or the solution may overflow when the battery is being charged, causing some acid loss.

12-2.2.1.2. Hold-down arrangement. Check the hold-down arrangement which should hold the battery firmly but not injure it. Most manufacturers provide heavy-duty batteries for use in tractors, and the cases of these batteries are designed to withstand the extra jolting and bouncing of tractor service. However, if the battery is not securely fastened, the case may be damaged when the tractor is operated over rough ground.

12-2.2.1.3. Cranking capacity. Cranking capacity is especially critical in cold weather. A fully charged battery has only 40 percent of the capacity at 0° Fahrenheit that it has at 70° Fahrenheit. Yet, it takes at least as much power to start an engine at the lower temperature so it is important to keep the battery fully charged. The amount of charge is best checked with a hydrometer. A trickle charger that operates on 110 volt a.c. can be used to keep a battery fully charged. The charger is plugged into an electrical outlet, and two small wires are clamped to the battery terminals. It charges slowly and should be left attached for some time, even overnight. If a good battery needs frequent recharging, check the generator and regulator performance. Do not expect a battery to give

dependable service for much longer than the guarantee period, especially in cold weather.

12-2.2.1.4. Corrosion. An accumulation of corrosion products or fuzz at the terminals of a tractor battery indicates two things: poor maintenance and a battery unable to contribute fully to tractor performance. When a battery is charged by the generator, the hydrogen gas given off escapes from the cells. The gas carries with it a very slight amount of acid. This vapor settles on the battery top and provides a damp surface to which dust and dirt cling. The acid attacks the metal of the battery terminals, the cable clamps, and the frame that holds the battery in place. The corrosion products form a path that permits the battery to discharge itself. All batteries not in use have a tendency to discharge, but if corrosion has collected on top of the battery, the rate of discharge is much faster. If allowed to continue, other corrosion products may eventually form an insulating layer between the battery terminals and the cable clamps. This tends to increase circuit resistance and prevents full battery capacity from reaching the starter motor.

12-2.2.1.5. Cleaning. To prevent an increased rate of self-discharge and poor starter performance, battery terminals and cable connectors should be cleaned at regular intervals to prevent corrosion formation.

12-2.2.2. Preparation for seasonal use.

12-2.2.2.1. Lubricants. If recommended in the operator's manual, switch to lightweight lubricants during the winter. Some tractors need hydraulic fluid which is used in hydrostatic transmissions and in implement operations such as lift cylinders and three-point hitches. Like engine oil, hydraulic fluid must lubricate, protect against corrosion, and retard foaming. It must carry extreme forces at high pressures to perform work. Purchase the type of hydraulic fluid recommended by the machinery dealer since most manufacturers warn that warranties will be invalidated if the operator adds any brand other than that recommended.

12-2.2.2.2. Air cleaner. Check the air cleaner on a tractor to see if it is the replaceable dry type or the oil-bath type. A replaceable filter should be replaced for winter. An oil-bath filter should be cleaned and the oil replaced by a lubricant of the same weight as that in the engine crankcase.

12-2.2.2.3. Electrical system. Winter places harsh demands on the electrical system of tractors or other powered machines. Lights may be used more often, and starting is more difficult and protracted. Therefore, it is

important to make sure the electrical system is in topnotch condition. First, give the system a visual check and replace any frayed or cracked cables. Check the battery to make sure the electrolyte is at the required level. Then, put a battery charger on the battery, charge it fully, and make sure it is kept fully charged. A weak battery can fail to deliver enough energy to start a tractor on a cold day, and a discharged battery can easily freeze during a cold snap.

12-2.2.2.4. Spark plugs. Check the spark plugs. If new ones were installed during the previous spring, cleaning, setting the gap, and reinstalling them will probably suffice. Older ones, in doubtful condition, should be replaced. Distributor points should then be set by following the instructions in the operator's manual step by step.

12-2.2.2.5. Fuel system. If the fuel was not drained from the machine at the end of the last operating season, it should be drained immediately. Last season's fuel may contain gum and varnish that will cause carburetor parts, such as the float valve and main jet, to stick.

12-2.2.2.6. Drive belts. Drive belts should be inspected before each season of use, and belts that are cracked or frayed should be replaced.

12-2.2.2.7. Snowblower. It is important that the auger, blower, and discharge chute be kept clean and free of rust. Rust spots should be sanded clean and the areas repainted. It is advisable to use a silicone spray on the auger, blower, and discharge chute before each use of the machine, particularly if the machine is used in wet snow. If the discharge chute becomes plugged with snow, always be sure to shut off the engine and disconnect the spark-plug wire before attempting to clear the chute.

12-2.23. Engine oils. To perform its essential lubrication job, an oil must remain at the right thickness across a broad temperature range without wearing out and turning into sludge or allowing metal surfaces to rust.

12-2.2.3.1. Viscosity. The first important measure of oil performance is its thickness or body. An oil must be thin enough to run freely through tiny passages in the tractor or mower engine; yet, it must be thick enough to resist scuffing and abrasion. A basic fact is that oil tends to be thicker (have higher viscosity) at low temperatures and thinner at high temperatures. Viscosity is the "weight" listed on the top of the can, usually SAE 5, 10, 20, or 30. Oils of 5- and 10-weight are low-viscosity oils. Oils in the 30- and 40-weight range are of comparatively high

viscosity. If two numbers are indicated (for instance, 10W30), it means that the oil is a multiple-viscosity grade; the oil behaves like a thin SAE 10W at low temperatures and like a thicker SAE 30 oil at high temperatures. The only safe rule to follow in selecting a weight is to choose the oil recommended by the implement's manufacturer; use the exact grade of oil listed in the owner's manual.

12-2.2.3.2. Oil service classifications or grades. The service classifications listed on oil cans tell what function the oil is manufactured to perform. Obviously, an oil designed for service in a lawn mower, for example, would not work well in a diesel-truck engine. Oil

manufacturers have developed a series of service grades to guide in the selection of the right oil. Some two decades ago, The American Petroleum Institute (API) sponsored the development of a series of API engine classifications: ML, MM, MS, DG, DM, DS. About 1970, a new system of API service classifications was devised. The new system includes nine classes: five for spark-ignition engines and four for diesel engines. The new and old systems are compared in table 12-4.

12-2.2.3.3. Engine oil requirements. Inside a tractor or mower engine, the oil lubricates, transfers heat, cleans, holds dirt in suspension, and protects against corrosion.

Table 12-4. Oil Classifications

New API service class	Previous API service class	Typical duty
Service-station classes		
SA	ML	Gasoline and diesel engines in utility service
SB	MM	Gasoline engines in minimum-duty service
SC	MS(1964)	Engine-warranty maintenance service for 1964 through 1967 gasoline engines
SD	MS(1968)	Engine-warranty maintenance service for gasoline engines beginning with 1968 models
Commercial and fleet engine services		
CA	DG	Diesel engines in mild to moderate duty with high-quality fuels
CB	DM	Diesel engines in mild to moderate duty with lower-quality fuels
CC	DM	Lightly supercharged diesel engines in moderate to severe duty and certain heavy-duty gasoline engines
CD	DS	In severe operating conditions; supercharged diesel engines in high-speed, high-output duty

Note: This data is not all inclusive. Improved oils are continually being researched and developed.

12-2.2.3.3.1. Check the oil level before operating any engine. On tractors, oil is usually measured with a dipstick with two marks. The top mark indicates whether the oil is full and the bottom mark indicates whether it is low. Never operate a tractor with the oil level below the bottom mark. On lawn mowers, the oil level is usually measured by removing a plug and observing the oil height. If the oil is low, the mower should not be operated until oil has been added to the indicated level.

12-2.2.3.3.2. Follow the instructions in the operator's manual concerning change intervals and procedures. Also use an oil with the viscosity specified in the owner's manual.

12-2.2.3.3.3. Before changing oil, run the engine until it warms to a normal operating temperature. This procedure agitates the oil and gathers up the contaminants and dirt in the crankcase so that most of them are removed when the oil is drained.

12-2.3. Preparation for Winter Storage. Winterizing is simplified considerably if powered equipment is not going to be used during the winter. The level of service for winter storage for a tractor is the level of service which should be given all other grounds maintenance equipment.

12-2.3.1. Cleaning and painting. The first step in winterizing is a thorough cleaning. Then the paintwork should be closely inspected. Use steel wool or sandpaper to clean rust spots from painted surfaces. Use a spray primer and paint to touch up the surfaces and restore the implement to a newish appearance.

12-2.3.2. Coolant. Look at the engine. If the equipment needs a tuneup or major service, now is the time to take it to the shop. If no tuneup is needed, proceed with simple winterizing. For machines with a separate cooling system, such as water-cooled tractors, check the coolant level and temperature at which it freezes. If adequate

protection for the expected temperature in the area is not provided, either add the necessary coolant or drain the coolant. Remember that there are taps on the bottom of the radiator and on the engine block; both must be opened for complete draining. Place a tag in a highly visible spot which notes that all coolant has been removed, and that the drains are open. This step helps to avoid damage should someone else try to start the engine in the spring before checking to make sure there is a proper coolant supply.

12-2.3.3. Lubricants. Drain the oil from the engine crankcase. Some manufacturers recommend that the crankcase be refilled immediately with the oil to be used next season. Others recommend refilling with a flushing mixture which can be left during the winter. If the crankcase is left empty or refilled with a flushing solution, it is imperative to place another tag near the control area so that the tractor will not be inadvertently started without the proper lubricant.

12-2.3.4. Fuel system. It is a good practice to drain the fuel system, including the tank, carburetor, and fuel lines. Leave the drains open and let the system dry out naturally.

12-2.3.5. Battery. For the best protection of the battery, remove it from the machine, recharge it fully, and store it

in a dry place where the temperature is above freezing. If the battery is left on the tractor in freezing temperatures, keep it fully charged to prevent freezing.

12-2.3.6. Waxing. The last step for winter storage is protection of the exterior painted surfaces and brightwork. A good, heavy coat of wax will keep the equipment looking good during the winter and provide considerable rust protection.

12-2.4. Winter Care for Hand Tools. Hand tools are the easiest equipment to prepare for winter. The essential job is to prevent rust, but other tasks which prolong hand tool life can be accomplished at the same time. Examine hand tools for irreparable damage or wear. Discard the summer casualties and then replace them. Examine the remaining tools. Wood handles can often be glued with a suitable epoxy or wood cement if the damage consists merely of a crack. Then rub a coat of boiled linseed oil into the handles of all implements. Finally, use either a commercial rust remover or a pad of steel wool to clean off any rust. Painting a tool protects against further rust, but adequate protection can also be provided by a thick coat of heavy oil on the metal parts.

CHAPTER 13.
POLLUTANTS AFFECTING PLANTS

13-1. Definition. Pollutants recognized herein are substances, usually chemical in nature, which invade water, soil, and air and cause some form of injury to plants.

13-2. Soil, Water, and Foliar Pollutants.

13-2.1. Salts, Damage, and Remedial Measures.

13-2.1.1. Salts.

13-2.1.1.1. Sodium Chloride (common salt). The most common pollutant of soil and water is sodium chloride. It is used as a deicer to melt snow and ice in winter and as a water softener in homes and cities. One of the components, sodium, not only is toxic to plants when in high concentration but also destroys soil structure so that plants growing therein may suffer from lack of aeration in the root zone. Chlorine, the other component, is toxic to most plants at a concentration of 100 parts per million. It is commonly added to potable waters from town and city reservoirs as a sanitary precaution against pathogenic organisms.

13-2.1.1.2. Calcium Chloride. In regions where the temperature drops below 0° F, sodium chloride is not effective as a melting agent on streets and highways. Calcium chloride is effective, however, to -50° F. It is twice as expensive as common salt and, therefore, is

used only in periods of extreme low temperature. Plants seem to suffer more from soil contamination by calcium chloride than by common salt.

13-2.1.1.3. Fertilizer salts. Ammonium nitrate, ammonium sulphate, and urea may be used to melt snow and ice. The soil where runoff occurs may accumulate an excess of nitrogen from these fertilizers which can cause "root-burn" injury to plants.

13-2.1.2. Roadside salt damage. In the snow belts where salt is heavily applied to the road surface, salt damage is common. Roadside salt damage is of two kinds: salt accumulation at the pavement edges, and splash from traffic. The first is cumulative in the soil and the plant. The first evidence is leaf margin burn and lack of vigor, followed by tip die-back and eventual death of the entire plant. Splash damage is most evident on evergreens planted too close to the highway. There is burning and defoliation on the pavement side with healthy foliage on the back side. Salt splash damage can occur on deciduous plants by absorption through the lenticels (pores) on the stems. Some plants' resistance to salt and salt spray damage are given in table 13-1.

Table 13-1. Tolerance of Some Plants to Salt and Salt Spray

Excerpt from "Seaside Plants of the World," by Edwin A. Menninger

HERBS AND SHRUBS		Belt I*	
Hardy	Half hardy	Tender	
Baccharis, Eastern	Chrysanthemum, Marguerite	Saltbush, Australian	
Saltbush, Fat-hen	Eriogonum, Ashy leaf	Saltbush, Big	
Saltbush, Mediterranean	Sea Ox-eye	Saltbush, Five-stamen	
	Belt II		
Bayberry	Autumn olive	Allspice, Carolina	
Bladder senna	Baccharis, Narrowleaf	Cherry, Hollyleaf	
Broom, Warminster	Barberry, Darwin	Daisybush	
Cotoneaster, Small-leaved	Barberry, Pratt	Daisybush, Coin leaf	
Heather, Scotch	Barberry, Rosemary	Lantana	
Honeysuckle, Box	Broom, Scotch	Pittosporum, Karo	
Matrimony vine, Chinese	Comprosmia, Hedge	Tephrosia, Purple	
Matrimony vine, Common	Elaeagnus, Thorny		
Plum, Beach	Knotweed, Pinkhead		
Rose, Rugosa	Lavender cotton, Grey		

Table 13-1. Tolerance of Some Plants to Salt and Salt Spray-Continued

HERBS AND SHRUBS		
Belt II		
Hardy	Half hardy	Tender
Salt-tree, Siberian	Marsh elder	
Sea buckthorn	Marsh mallow	
Sumac, Smooth	Tamarisk, Fivestamen	
Sweet pepper bush	Verbena	
Willow, Goat	Wax myrtle	
Willow, Creeping		
GRASS AND GRASS-LIFE PLANTS		
Belt I		
Beachgrass, American	Japanese lawngrass	Agave
Beachgrass, European	Kikuyugrass	Screwpine, Common
Bluestem, Little	Pampasgrass, Selloa	Screwpine, Veitch
Cordgrass, Salt-meadow	Panicgrass, Bitter	
Cordgrass, Townsends	Panicgrass, Dune	
Fescue, Red	Paspalum, Seashore	
Lovegrass, Purple	Reed, Giant	
Reed canarygrass	Saltgrass, Seashore	
Sea lymegrass	Sea oats	
Wildrye, European dune	Yucca, Aloe (Spanish Bayonet)	
	Belt II*	
Tall fescue	Bermudagrass	St. Augustinegrass
	Daylily	
GROUND COVERS		
Belt I		
Bearberry	Daisy, African	Lantana, Trailing
Glorybind, Seashore	Ivy, Algerian	Morning glory,
Juniper, Shore	Jackbean	Soilbind
Thrift, Common	Mesymbranthemum	Peavine, Maritime
Wormwood, Beach	Sedum, Goldmoss	Plum, Natal
Winter creeper	Sunflower, Cucumberleaved	
	Belt II	
Cottoneaster, Rock	Mondo grass	Cowpea, Seashore
honeysuckle, Japanese	Verbena, Sand	Fig, Rooting
Juniper, Creeping		Hemp, Bowstring
Lily turf		
Rose, Memorial		
Snow-in-summer		
Yew, Spreading		
VINES		
Belt I		
Virginia creeper or Five leaf ivy	Butterfly pea, Coastal	
	Treebine, Ivy	
	Belt II	
Bittersweet	Hydrangea, Climbing	Allamanda, Common
Grape, Fox		Bouganvillea
Honeysuckle, Everblooming		Jasimine, Italian
Ivy, English		
Trumpet creeper		
Winter creeper		

Belt I -Right on Shore

*Belt II-with some protection

13-2.1.3. Remedial measures. The most practical methods for control and repair of salt injury are:

13-2.1.3.1. Use only clean, uncontaminated water. If city-supplied water does not meet specifications, explore the possibility of using water from streams, lakes, or pumps from the ground.

13-2.1.3.2. Use a minimum of salt as a deicer along walks and roads where valuable plants are located. Abrasives such as sand can be substituted for salt.

13-2.1.3.3. Apply clean water in abundance to soils which have been contaminated with salt in order to leach out pollutive material.

13-2.2. Metallic Chemicals. Soil may become contaminated from the residues of spray materials containing copper, arsenic, and other metallic substances. The decomposition of these materials proceeds slowly, and often, new applications of spray material create accumulation faster than decomposition can take place. Presently, however, organic spray materials are used more frequently than metallic, inorganic ones.

13-2.3. Herbicides. Herbicides applied in excess amounts or deposited by runoff can contaminate soil and prevent or injure plant growth (para. 11-3.). Activated charcoal worked into the soil can take up and inactivate some of the injurious substances. Another method of freeing soil of these chemicals is to leach them by applying water frequently for several weeks.

13-2.4. Buried Organic Matter. Plant residues and other organic matter covered with earth, as in landfills, may undergo anaerobic respiration which produces certain phytotoxic gases such as methane and sulphur compounds. These gases may move laterally in the soil and injure trees and other plants a considerable distance away.

13-3. Air Pollutants. Phytotoxic (i.e., poisonous to plants) gaseous substances in the air may come from local or worldwide sources.

13-3.1. Local. Local pollutants may be gaseous or

particulate matter. Sulphur dioxide, generally the most common air pollutant, is formed from the combustion of coal and industrial manufacturing. Fluorides are also produced by coal-burning and manufacturing facilities. Particulate material includes small, windborne particles of cement dust, ceramic dust, and soot which may be carried some distance. They can injure plants by clogging leaves through the stomata, injuring the chloroplasts, and reducing photosynthesis.

13-3.2. Extraterrestrial. Pollutants formed in the outer atmosphere of the earth and carried long distances include ozone (O₃) and peroxyacetyl nitrate (PAN).

13-3.3. Symptoms and Tolerance. The symptoms of air pollution may be lesions of dead tissue between the leaf veins, mottling or chlorosis of the leaf blade, and browning and drying of the leaf margins. The symptoms vary not only with the pollutant involved but also with the species of plant and its condition. Some plants are much more tolerant than others of air pollution, particularly from local-source pollutants. A list of these plants can usually be obtained from the state agricultural experiment station or cooperative extension service. In addition, although the evidence is still circumstantial, it is thought that some plants can absorb and filter out pollutants, thus cleaning the air for all organisms.

CHAPTER 14.
 SAFETY

14-1. Management and Administration.

14-1.1. General. Commanders are responsible for, accountable for, and authorized to: design, develop, implement, and administer an effective safety program related to natural resources management. Various Executive Orders and DoD documents related to safety management and administration apply to all missions within Federal Agencies, including natural resource management. Safety precautions and safe and maintenance practices are included in the following:

- | | |
|------------------|--|
| AFR 127-101, | Ground Accident Prevention Hand-book. |
| NAVFAC 5100.11B, | Safety Program Management. |
| TM 5-629 | } Herbicide Manual |
| NAVFAC MO-314 | |
| AFM 91-19 | } Military Entomology Operational Handbook |
| TM 5-632 | |
| AFM 91-16 | |
| NAVFAC MO-310 | |

AFR 127-12, Air Force Occupational Safety & Health (AFOSH) Program. US Department of Labor Occupational Safety and Health Administration-OSHA 2206 (29 CFR 1910). General Industry Safety and Health Standards.

For safety training in preparedness or presuppression activities, and safety precautions in fire suppression, see chapter 10, Fire Protection on Military Lands.

14-1.2. Management. Commanders will insure that policy, programs, and project safety plans are developed to provide a safe and healthful environment for employees (civilian and military), contractor work forces that may be required to be in the areas, and the visiting public.

14-1.3. Administration. Commanders should take advantage of the professional safety directors that service their commands for assistance in developing policy and programs pertinent to their specific activity. Commanders should conduct periodic surveys to determine the effort and effectiveness of resource managers in implementing and complying with established safety programs.

14-2. Health and Environment.

14-2.1. General. Personnel employed in establishing and maintaining the varying requirements relating to natural resources management are often exposed to health hazards and potential bodily injury. Operations requiring the handling, storing and use of fertilizers, lime and other soil amendments, or pesticides and soil sterilants may require the wearing of approved respiratory equipment, goggles and protective clothing. Safety shoes should be worn when performing jobs exposing the feet to injury by machines such as powered lawn mowers and on jobs requiring the handling of heavy objects. Personnel not fully trained and skilled must be closely supervised at all times. Effective training programs, including on-the-job training, must be established in order to attain the highest possible skill level. Training must include accident prevention policies and safe operation procedures.

14-2.2. Medical Consultation and Examinations. Preventive Medicine personnel will assist and provide consultation service concerning health hazards occurring during natural resources management operations. Prompt medical attention will be provided for any injury. Practical measures for the prevention of disease and injury and job related guidelines for medical treatment and periodic medical examinations, as may be appropriate to natural resources management personnel, are contained in AR 40-5 and AFRs 127-12 and 161-33 (app. A, no. 13).

14-3. Protective Clothing and Equipment. These items will be issued at the option of the installation commander. They include, but are not limited to, coveralls, gloves, safety shoes, headgear, goggles and respirators. Guides for the use and care of recognized occupational safety clothing and equipment are Contained in DA Pam 385-3 and AFOSH Standards 127-31 and 161-1.

14-4. Pesticides. The Environmental Protection Agency (EPA) has issued a number of regulations pertaining to substances which may have toxic effects on humans and other organisms within the environment. Among these

substances are pesticides which control plant disease organisms, fungi, weeds, nematodes, slugs, snails, mites, insects, and rodents. Pesticides are of varying types. Some kill by contact, affecting only the tissues they touch; others are taken into the plant or animal body and affect its entire system. Some pesticides act instantly; others act over a period of time. Some degrade very quickly; others break down quite slowly and may persist in the environment for months or even years.

14-4.1. Control of Pesticides. EPA regulates the manufacture, sale and use of pesticides and the training and certification of pesticide applicators using restricted pesticides. The Department of Defense (DOD) pesticide applicators receive intensive training and testing to determine those who qualify for certification. Such personnel are not required to have state certifications; Federal employee applicators of pesticides on military proper- ties need only be certified in accordance with the DOD certification program. However, all contracted pesticide applicators working on military properties must be certified and licensed by the State.

14-4.2. Container Labels. The label on each pesticide container regulates the use of that pesticide; no deviations may be made from the instruction, except as approved by EPA. The label contains the EPA registration number used for the identification of the product. The label also identifies the chemical(s) (i.e., active ingredient(s)), common name, trade name, chemical name, any hazards, the use for which the pesticide is registered, recommended dosage, limitations, compatibility when mixed with other substances, phytotoxicity or injury to plants, storage and disposal precautions, and the degree of hazard to humans (wherein, DANGER and the skull and crossbones=poison, most hazardous; WARNING=moderately toxic; and CAUTION=slightly toxic or relative13 nontoxic). It is illegal to exceed the maximum recommended dosage on the label.

14-4.3. Safety Rules. The rules to be observed by DOD pesticide applicators are:

14-4.3.1. Read and follow the instructions on the pesticide label.

14-4.3.2. Wear the required protective clothing and appliances (masks, etc.) when using a pesticide.

14-4.3.3. Use proper application equipment. Keep the equipment in good condition.

14-4.3.4. Store pesticides in isolation from other substances.

14-4.3.5. Dispose of empty containers in accordance with EPA and DOD instructions.

14-4.3.6. Wash down spray equipment in accordance with EPA and DOD instructions.

14-4.4. Current Information. New pesticides are

constantly being developed and registered for sale and use. In addition, both Federal and State regulations are frequently changed. It is important, therefore, for pesticide applicators to keep informed of the latest developments. The easiest way to obtain current information is to contact the Pesticide Hot Line (app. D, no. 6). major commands, and the State agricultural extension service through the local county agricultural extension agent, and to request placement on the mailing lists for periodic circulars on pests and pesticides.

14-5. Poisonous Plants. In this group are included a wide variety of plants whose plant parts are toxic to humans or animals by contact or ingestion. The State agricultural extension service, through the local county office, is a good source of assistance on plant identification. In case of possible plant poisoning call the installation medical center, the nearest physician or check with the nearest Poison Control Center. Such emergency telephone numbers should be kept by the telephone. Preventive measures should include a program of education to recognize the immediate danger and, when practicable, a specific program of eradication. Some poisonous plants are given in table 14-1.

14-5.1. Woodland or outdoor recreation areas are frequently infested with poison ivy (*Rhus radicans*), poisonoak (*Rhus toxicodendron* and *Rhus diversiloba*), and poison sumac (*Rhus vernix*). The toxic agent is a phenolic substance called urushiol which causes severe inflammation of the skin.

14-5.2. Garden ornamentals including castor bean (*Ricinus communis*), oleander (*Nerium oleander*) and common mistletoe (*Phoradendron spp*) contain dangerously poisonous substances which can be fatal if ingested in relatively small amounts. The toxic substance, ricin, is found in the fleshy part of the mature seed of the castor bean. All parts of the oleander plant contain a toxic material and the smoke of the burned leaves may affect some persons. The whitish green berries of mistletoe are poisonous to eat.

14-5.3. Poisonous plants are relatively common on range land but most are distasteful to livestock and are eaten in harmful amounts only when good forage is lacking. Halogeton (*Halogeton glomeratus*), tansy ragwort (*Senecio jacobaea*) and milk vetch (*Astra galus spp*) have been the cause of serious livestock losses in the past.

14-5.4. Plants which contain potentially toxic drugs or narcotics may frequently be found growing wild and should be eradicated to eliminate the dangers involved.

Common examples are foxglove (*Digitalis purpurea*), marijuana (*Cannabis sativa*), and sacred-datura (*Datura meteloides*).

Table 14-1. Some Selected Poisonous Plants

<i>Scientific name (species-spp.)</i>	<i>Common name</i>
<i>Asclepias galioides</i>	Poison milkweed
<i>Astragalus</i> spp.....	Poison milkvetch
<i>Cannabis sativa</i>	Marijuana
<i>Cicuta douglasii</i>	Water hemlock
<i>Conium maculatum</i>	Poison hemlock
<i>Datura meteloides</i>	Sacred-datura
<i>Datura stramonium</i>	Jimson weed.....
<i>Delphinium</i> spp.....	Larkspur.....
<i>Digitalis purpurea</i>	Foxglove
<i>Phoradendron</i> spp	Mistletoe
<i>Halogeton glomeratus</i>	Halogeton
<i>Lupinus</i> spp	Lupine.....
<i>Nerium oleander</i>	Oleander.....
<i>Rhus diversiloba</i>	Poison-oak.....
<i>Rhus radicans</i>	Poison-ivy
<i>Rhus toxicodendron</i>	Oakleaf-ivy
<i>Rhus venix</i>	Poison sumac
<i>Ricinus communis</i>	Castor bean
<i>Sarcobatus vermiculatus</i>	Greasewood.....
<i>Seneciojacobaea</i>	Tansy ragwort
<i>Solanum nigrum</i>	Black nightshade
<i>Veratrum californicum</i>	False hellebore
<i>Xanthium pensylvanicum</i>	Cocklebur.....
<i>Zigadenus</i> spp.....	Deathcamas.....

14-6. Equipment.

14-6.1. Prevention of accidents and injuries involving power equipment requires that safety features be built into, or installed onto, the specific piece of equipment; that detailed operation and maintenance procedures provided by the manufacturer be strictly complied with; and that rules for safe operation be followed. Examples of installed safety features are: an anti-roll bar which guards against personal injury in tractor rollover or rear

tipover accidents; and a brush guard to protect tractor operators while moving through brush areas or under overhanging limbs.

14-6.2. Effective training programs, including on-the-job type training, must be conducted to attain the highest possible operational skill level. Unsafe practices and conditions detected must be corrected. Conditions beyond the scope of grounds maintenance personnel will be referred through the command for corrective action.

PART II. LAND MANAGEMENT AND GROUNDS MAINTENANCE.
CHAPTER 15.
ESTABLISHMENT AND MAINTENANCE OF GROUNDS

15-1. General Provisions. Maintenance of grounds is essential to the mission of the DOD installation. Lands, facilities, and equipment must be protected continuously from deterioration and depreciation by dust and erosion. Welfare and morale of personnel is fostered by healthful, pleasant surroundings, and suitable outdoor recreational facilities. To accomplish these objectives, grounds maintenance operations should be conducted in an orderly sequence designed and adjusted to take advantage of the varied ecological factors involved, including climate, topography, soil vegetation, and land use. Timeliness in the application of accepted agronomic practices and techniques is essential to their success.

15-2. Critical Plant and Animal Habitats. Critical habitats of endangered and threatened native species of flora and fauna must be preserved and protected. Critical habitat areas will be identified and posted as necessary to assure that grounds maintenance activities do not disturb these protected areas. (See para. 4-3, Outdoor Recreation and Cultural Values publication (app. A, no. 5), and the Fish and Wildlife Management publication (app. A, no. 4).)

15-3. Special Interest Areas. Special interest areas should be designated in the natural resources management plan, and those of exceptional value should also be placed on national and State registers.

15-3.1. Historical and Archeological Areas. Procedures for identifying and preserving historical and archeological properties are described in Historic Preservation: Administrative Procedures, and Historic Preservation: Maintenance Procedures (app. E, no. 13). Grounds maintenance activities involving, or supporting, historical and archeological areas will comply with Executive Order 11593, "Protection and Enhancement of the Cultural Environment," and PL 96-95, "Archeological Resources Protection Act of 1979."

15-3.2. Natural Areas. There is a Natural Landmark Program administered by the Heritage Conservation and Recreation Service for the purpose of preserving nationally significant areas of ecological biological and geological importance. (See para. 4-4.2 and the Outdoor Recreation and Cultural Values publication (app. A, no. 5).) Preservation does not exclude natural resources

management in all situations. For example, a natural landmark which contains an important geological feature may be able to sustain grazing or timber cutting, both uses which will not adversely affect the geological feature. The experts and professionals who helped to identify the special interest area should provide guidance concerning the kinds and levels of use which the area can withstand without damage. Some special interest areas may require protection beyond their immediate confines to discourage improper use or pollution from encroachment. In these situations, buffer zones should be established which permit only the most compatible uses.

15-4. Preventive Maintenance. To operate grounds work on the basis of accomplishing repairs when failures occur will soon result in a fairly complete breakdown of a grounds maintenance program. Work on grounds must be accomplished at the season when the stage of plant growth is favorable and when soil and climatic conditions permit. Many operations, such as reseeding perennial grasses, must be done at prescribed favorable periods or they will be unsuccessful and may not be undertaken again successfully until the following year. Well-maintained grounds provide a comfortable margin of reserve for emergencies, and this is provided by a preventive maintenance program which anticipates requirements and accomplishes work when it can be done with the least effort and expense. The grounds crew should consist of persons having experience in maintaining plant growth and in handling the special equipment required. Without a designated grounds maintenance crew, it will be difficult, if not impossible, to accomplish preventive maintenance satisfactorily. Some important areas and activities requiring scheduled preventive maintenance operations are as follows:

15-4.1. Erosion Control. Early detection of wind and water erosion permits immediate corrective action to prevent serious damage to grounds. Schedule

frequent inspection of installation grounds to identify erosion areas and to collect data for development of project estimates if damage is severe enough to warrant major repairs. Methods and means to prevent or correct erosion (terraces, vegetated channels, and masonry structures) are described in chapter 7.

15-4.2. Field Drainage. In addition to scheduled inspections, during and after heavy rains check for flood damage and ponding of water in building areas, improved grounds, and areas adjacent to fixed structures. Ponds developing on lawns and physical training areas indicate the need for correction of grade or installation of tile. Correct grades to direct excess water into the existing drainage system. If structures or grounds are damaged, reevaluate the watershed requirements and redesign the drainage system to provide for adequate water disposal. Check all drainage channels to determine maintenance requirements. Clean channels and reduce slopes where necessary to permit planting of easily maintained vegetation.

15-4.3. Fire Hazards. Adopt approved fire-preventive measures (chap. 10). Identify areas with excess flammable material and reduce it. Firebreaks minimize fire hazard by localizing fires if they break out. Check and determine if firebreaks are clear of flammable material which would allow fire to cross the break. Use herbicides to control brush and weeds (Herbicide Manual (app. A, no. 11).) Burn excess vegetation only during periods when fires are readily controllable. Take into account the time of day, season, soil moisture, humidity, and flammability of the material to be burned. Before burning brush and weeds, make sure there is adequate firefighting equipment on hand to control the fire or extinguish it quickly. Coordinate all burning with guidelines contained in chapter 10.

15-4.4. Control of Objectionable Plants. Objectionable plants include those which are poisonous to personnel and animals, those which adversely affect the appearance of grounds, and those which interfere with the efficiency of drainage systems. Study State lists and laws pertaining to noxious plants in your locality and learn the approved methods of controlling them. Remove cattail, willow, water hyacinth, and other undesirable plants from drainage systems by spraying with herbicides or other effective means. Prevent field bind-weed, Canada thistle, halogeton, quack grass, and other undesirable growths from spreading to uninfested areas, especially areas used for agricultural purposes. Mow Russian thistle frequently to prevent it from going to seed.

15-4.5. Equipment and Supplies. Keep grounds maintenance equipment in working order by frequent inspection and prompt repair. Check kinds and quantities of repair parts needed to assure that equipment will be serviceable when needed. Keep fire plows and other firefighting equipment ready and available for use in emergencies. Evaluate the requirements for seed, herbicides, and fertilizers, and requisition adequate quantities of fresh supplies sufficiently in advance so that they will be on hand when needed.

15-4.6. Trees and Shrubs. Prune shade trees to reduce the possibility of damage from wind and ice. Schedule the pruning of trees the branches of which overhang power lines or grow into them. For new plantings, select trees and shrubs that are adapted to the local soil and climate and are resistant to disease and insects. Remove unnecessary plants that require extensive maintenance (hedges that require frequent trimming, crowded shrubs, etc.) and those that interfere with the use of tractor-operated mowers. Remove and destroy diseased plants, especially those that have diseases likely to spread to other plants, and trees that have been seriously damaged by insects. Remove decayed trees and dead branches, especially those that threaten to fall on structures, power lines, road-ways, walkways, and rail lines.

15-4.7. Grading and Smoothing.

15-4.7.1. Improved grounds. Smooth, fill, or grade areas where ground surfaces are too rough or irregular for satisfactory equipment operations. Check elevations with instruments to assure satisfactory drainage. Install drainage structures where grading will not be adequate.

15-4.7.2. Unimproved grounds. Remove stumps, rock, and other obstructions that interfere with mowing equipment. Removal of obstructions to mowing is important in many unimproved ground areas because mowing is an essential fire-prevention measure. Clear and grade abandoned building sites so that they can be mowed with tractor-operated equipment. Maintain wooded areas in accordance with recognized woodland management procedures to conserve the resources and to reduce fire hazards which may endanger installation property.

15-5. Grasses and Legumes.

15-5.1. Scope. This chapter prescribes methods to use

in establishing* and maintaining grasses and legumes for use in land utilization categories as follows:

Improved grounds (e.g. lawns, parade grounds, and recreation areas).

Semi-improved grounds (e.g. airfields, heliports, field training areas, antenna fields, ammunition magazines, and embankments).

Unimproved grounds (e.g. firing ranges, wildlife food and cover areas, agriculture or grazing outleasings, fire breaks, and drop zones). Maintenance activities are included in a general manner. For specific maintenance refer to chapters 6, 8, 11 and 16 for drainage, fertilizers/amendments, vegetation control, and irrigation respectively; to paragraph 15-13 for mowing practices; and to paragraphs 15-7, 15-9, and 15-10 for maintenance of golf courses, roadsides, and antenna facilities, respectively.

15-5.2. Areas.

15-5.2.1. Improved grounds.

15-5.2.1.1. *Lawn type plantings.* Plantings in this category are used for lawns, cemeteries, and adjacent areas where attractive appearance is necessary. Some foot traffic is expected on these areas. Irrigation is required for establishment and maintenance in most areas, especially in zones of low rainfall. Fertilizer rates are moderate. Mowing is normally accomplished on a weekly basis during the periods of rapid growth at a height of approximately 2-1/2 inches. (See para 15-13.) Renovation consists principally of topdressing to correct irregularities in grade, removal of thatch for species such as zoysia and the fine-leaf Bermuda grasses, fertilization, and replanting of bare spots. Crushed rock aggregate or similar material is used in low rainfall areas where irrigation is not available.

15-5.2.1.2. *Recreation areas and parade grounds.*

Plantings in this category are used for ball fields, parade grounds, children's playgrounds, golf courses, and similar areas where heavy foot traffic is expected. Irrigation is normally required for both establishment and maintenance. Underground irrigation systems are desirable in most planting zones. Fertilizer rates are relatively heavy to assure rapid recovery of the turf when damaged by foot traffic. Mowing is normally required on a twice weekly basis, at least during periods of rapid growth. Golf greens require almost daily mowing. Height of mowing is based on turf requirements of the activity concerned. Renovation consists of repairing traffic damage by filling holes and replacing sod, removal of

thatch, and heavy fertilization.

15-5.2.2. *Semi-improved grounds.*

15-5.2.2.1. *Ammunition magazines and embankments.* Vegetative and aggregate cover on these slopes is intended to control erosion. Fertilization is limited to seedbed treatment at time of establishment and occasional applications when necessary to prevent loss of the established planting. Irrigation is not required except when use of vegetative material (sprigs, plugs, plants) requires water to insure survival at planting time. Mowing is performed when necessary to preserve a vegetative cover, usually about twice annually. Height of mowing is normally 3 to 6 inches. Renovation consists of repair of eroded spots, replanting where necessary, and elimination of brush. Crushed rock aggregate, gravel, and similar materials are used in low rainfall areas where vegetation produces inadequate cover for erosion control.

15-5.2.2.2. *Airfields, heliports, field training areas, antenna fields, and similar areas.* Plantings for these areas are used primarily for control of soil erosion and dust control. Irrigation is unnecessary except where vegetative materials (sprigs, plugs, plants) require water to insure survival at time of planting. Fertilization is limited to seedbeds at time of planting for initial establishment and occasional treatments to prevent loss of established planting. Mowing of these areas will be required at intervals depending on intensity of use.

15-5.2.3. *Unimproved grounds.* Plantings in this category are used primarily for the control of soil erosion and required vegetative cover in outlying areas requiring soil stabilization of a watershed. This also includes reseeding required on agriculture or grazing outleasings and plantings adapted to wildlife food and cover. Mowing is normally performed only to prevent the development of fire hazard or excessive weed growth, usually once or twice annually.

15-5.3. *Species of Plants to Use.* The grounds maintenance supervisor has available a wide assortment of species and varieties of plants to use to establish vegetative cover. Some of these are described in the following paragraphs. Others may be determined to be more useful for specific sites after consultation with local agricultural agencies. Table 15-1 contains a summary of seeding rates of the principal plants used for various sites.

*Coordinate with the publication at app A, no. 15, "Planting Turf."

15-5.3.1. *Southern perennial grasses.* These grasses are also called warm-season grasses since they grow most actively during the warm summer months and are relatively dormant during the remainder of the year. Light

frosts usually turn these grasses brown in color. Many southern grasses are planted by vegetative material (springs or plugs) rather than seed.

Table 15-1. Seeding Rate Table

Kind	Pure live seed (percent)	Weed seed (percent)	Pounds per 1,000 square feet				Seeds per pound (thousands)	
			Lawns* (Note 1)	Recreational areas** (Note 2)	Embankments+ (Note 3)	Unimproved++ (Note 4)		
Bahia, Pensacola	56	0.50	2.0	30	20	160
Barley.....	89	0.10	3.0	50	50	14
Bentgrass.....	88	0.50	30	8,000
Bermuda, common ¹	82	1.00	1.0	2.0	1.0	30	15	1,750
Bluegrass, Kentucky	68	0.50	2.5	2.5	2.5	30	20	2,000
Bluegrass, Canada.....	64	0.50	2.5	30	20	2,000
Bluestem, little ²	14	2.00	3.0	35	25	250
Bluestem, King Ranch ²	33	2.00	2.0	30	20	750
Brome, smooth.....	80	0.50	3.0	30	20	150
Brome, annual ²	68	2.00	3.0	35	25	280
Buffalo.....	46	2.00	2.0	2.0	25	15	40
Carpet	83	0.50	20	20	1,500
Centipede.....	30	1.00	0.3	5	3	400
Clover, alsike ⁴	88	0.50	0.2	2	2	700
Clover, small hop ⁴	78	0.50	0.2	2	2	7,800
Clover, white ⁴	88	0.50	0.2	2	2	785
Dalisgrass	49	1.00	20	260
Fescue, chewings	78	0.50	3.0	3.0	40	30	600
Fescue, tall.....	88	1.00	5.0	5.0	5.0	50	35	200
Galleta ²	15	2.00	3.0	35	25	159
Grama, black ²³	9	2.00	3.0	35	25	1,300
Grama, side-oats.....	30	2.00	3.0	35	25	143
Grama, blue ²³	26	2.00	3.0	3.0	35	25	800
Harding grass.....	78	0.50	30	20	500
Indian ricegrass.....	45	2.00	3.0	30	20	141
Lespedeza, annua ⁴	86	1.00	0.5	20	20	340
Lespedeza, sericia	88	1.00	15	240
Lovegrass, weeping	80	1.00	2.0	0	25	1,500
Orchardgrass	81	1.00	5	500
Redtop	83	1.00	2.0	20	15	5,000
Rye	82	0.10	3.0	90	90	20
Ryegrass, annual	88	0.52	4.0	60	40	275
Ryegrass, perennial	88	0.50	4.0	4.0	4.0	60	40	335
Sand dropseed.....	65	1.00	1.0	25	15	5,000
Sorghum (sweet).....	83	0.25	3.0	75	75	75
Sudan.....	78	0.25	1.0	20	20	50
Timothy	89	0.25	25	15	1,200
Wheat	89	0.10	3.0	90	90	15
Wheatgrass, bluebunch.....	64	2.00	3.0	30	20	80
Wheatgrass, crested	81	0.25	4.0	4.0	30	20	200
Wheatgrass, fairway.....	81	0.25	4.0	30	20	300
Wheatgrass, intermediate	81	1.00	4.0	30	20	140
Wheatgrass, western	64	0.50	30	20	110

* Includes all lawn-type planting, cemeteries, etc.

** Includes parade grounds, children's playgrounds, etc.

+ Includes earth-covered magazines and roadsides.

++ Includes field plantings for erosion control not included in embankments.

¹ Rate based on unhulled seed. Use three-fourths these rates for hulled seed.

² Data furnished may not be reliable for a specific lot. Seed lot may have much higher or lower purity and germination percents.

Adjust seeding rates proportionately.

³Rate based on unhulled seed. Use half rates for hulled seed.

⁴Rate based on amount to be used in a seed mixture. Double these rates for pure seeding.

15-5.3.1.1. *Bahia grass (Paspalum notatum)* (fig. 15-1(9)). This long-lived perennial spreads from heavy stolons forming dense sod. It tolerates low fertility and sandy, somewhat droughty soils in the warm, humid southeastern states, being established by treated seed. It is principally used for grazing, airfields, roadsides, embankments, and unimproved grounds, seldom for lawns. The plant does not survive in dense shade.

15-5.3.1.2. *Bermuda grass (Cynodon dactylon)* (fig. 15-1(2)). Being both rhizomatous and stoloniferous it forms dense drought- and wear-resistant sod. It grows on a wide range of soils from heavy clays to deep sands, providing fertility is not limited. It will produce effective sod on both acid and calcareous soils. It tolerates saline conditions, but does not like waterlogged soils and is not shade tolerant. It is widely used on military installations in the south from warm-humid to semi-arid regions. It is ideal for physical training areas, airfields and other heavy- traffic areas. Irrigation is needed on sandy soils and semi-arid sites. It survives winter temperatures over a wider area than shown in figure 15-1(2), but other grasses are more suitable outside the area shown. The fine-leafed Bermudas are high- maintenance grasses requiring high nitrogen applications, frequent mowing, and specialized mowers, and should be restricted to recreational areas. Many strains have been developed, mostly for the southeast. The strain "U-3" is suitable for the Upper South and Pacific Southwest. "Coastal" is coarse-growing, useful for hay, pasture and rough lawns. "Tufcote," being mostly stoloniferous, is easily confined and more hardy than most improved strains.

15-5.3.1.3. *Bluestem, Little (Andropogon scoparius)* (fig. 15-1(13)). A long-lived native bunchgrass widely distributed but most prevalent in the flint hill sections of Kansas and Oklahoma. Growing from 1 to 3 feet tall, this drought-resistant grass is adapted to a wide range of soils and useful for range reseeding and erosion control plantings. Its near relative, Broomsedge (*Andropogon virginicus*), is often found in stands of Little Bluestem. Seed is not commercially available but hay, cut when the seed is ripening, and used as mulch on bare eroding sites, will establish stands. It is highly tolerant of low fertility soils and pioneers on many untreated subsoil sites.

15-5.3.1.4. *Bluestem, Yellow (Andropogon ischaemum)* (fig. 15-1(18)). The King Ranch variety is the most widely known and used. It is a semi-prostrate bunchgrass. Seed is available. It is valuable for hay, pasture and conservation plantings. It is best adapted to parts of Texas and Oklahoma, thriving on relatively shallow, low-fertility soils. Other strains are still in the testing stage.

15-5.3.1.5. *Carpet grass (Axonopus compressus)* (fig. 15-1(3)). It is the dominant stoloniferous species in many

pastures of the southern warm- humid region, growing on low-fertility, poorly drained soils. It is also suitable for extensive grassed areas. It is not as attractive as other lawn turf grasses since it produces seed heads that give an unkempt appearance. It is commonly grown in combination with low growing legumes, the most common being annual lespedeza, white clover and hop clover. These legumes supply a certain amount of nitrogen to the soil, thus benefiting the grass. Carpet grass will develop a satisfactory vegetative covering on poorly drained soil or on soil too low in fertility to support the common strains of Bermuda grass or other lawn grasses.

15-5.3.1.6. *Centipede grass (Eremochloa ophiuroides)* (fig. 15-1(5)). This low-growing stoloniferous perennial from Asia makes a dense turf of creeping stems and leaves. Adaptable to a wide range of soils in the coastal plain and gulf region to eastern Texas. It will grow on clay soils and even infertile sand, provided plant food and moisture are available to get it started. When maintained as a turf the fertilizer program must be managed to maintain the proper ratio of nitrogen and phosphorus. The heavier nitrogen ratio frequently used on Bermuda grass and St. Augustine grass is often detrimental to centipede grass. It tolerates shade better than Bermuda and almost as well as St. Augustine grass. Seed is sometimes available but it is usually established by sprigs or plugs.

15-5.3.1.7. *Dallis grass (Paspalum dilatatum)*. Dallis grass is useful for pastures and contributes valuable grazing throughout a large part of the Southeastern States (fig. 15-1(17)). It is a lawn weed, however, and its presence in lawns materially increases maintenance costs. It is an aggressive bunch grass, and its growth is marked by vigorous seeding stems which appear soon after mowing and make a ragged and unattractive turf. In pastures, dallis grass normally is mixed with carpet grass Bermuda grass, and legumes (hop clovers, white clovers, and lespedeza).

15-5.3.1.8. *Kikuyu grass (Pennisetum clandestinum)* Kikuyu grass is valuable for erosion control and lawns in the southern coastal areas of California and in Hawaii at

lower elevations. It spreads by rhizomes and stolons, produces very little seed, and is planted by sprigs like Bermuda grass. It can be a weed in irrigated cropland. It is not hardy where heavy freezes occur. Being drought resistant, it requires less irrigation than most turf grasses.

15-5.3.1.9. St. Augustine (*Stenotaphrum secundatum*). St. Augustine grass is known in some parts of Texas as carpet grass, but it should not be confused with carpet grass described in paragraph 15-5.3.1.5 above. The species is used principally for improved lawns. Some of the finest lawns in the South have been developed with it (fig. 15-1(7)). One of its more important advantages is that it endures shade better than any other lawn grass in the region to which it is adapted. St. Augustine is planted by sprigging (with stolons) or by spot sodding. In most regions it must be watered, at least during the drier parts of the summer. Because it does need irrigation, use of St. Augustine should be confined to small lawn areas where water is available.

15-5.3.1.1.0 Zoysia grasses (*Zoysia species*). Two common species of Zoysia grass are well adapted in the Southern States (fig. 15-1(4)). One, called Manila grass (*Zoysia matrella*), is a fine-leaved variety; the other, usually known only as Zoysia or as Japanese lawn grass (*Z. japonica*), is a broader-leaved type. The leading variety of this species is Meyer Zoysia. Mascarine grass (*Z. tenuifolia*), another fine-leaved strain, is not hardy except in Florida and southern California. Emerald Zoysia (*Z. japonica* x *Z. tenuifolia*) is one of the leading varieties in the Southern States. The Zoysias require less fertilizing and less mowing than most other lawn grasses. Zoysia is planted in one of two ways: by sprigging or spot sodding at 12- to 18-inch intervals. In sprigging, plantings are made with stolons; in spot sodding, small squares or plugs of grass are set into the soil or in existing sod of another variety of grass. Zoysia runners spread slowly and sometimes take two or three years to develop into a mature sod, even where weeds and grasses having been removed to make way for Zoysia. Development of mature sod can be hastened by using the proper kind and amount of fertilizer. Zoysia plugs planted in existing bluegrass sod will, where adapted, eventually replace the bluegrass and form a continuous turf. Complete lawn coverage using this method sometimes takes as much as 5 years. Mixing of Zoysias with Bermuda grass is not recommended.

15-5.3.2. Northern perennial grasses. These grasses are also called cool-season grasses since they grow most actively during the cooler months of the spring and fall and are relatively dormant during the summer. Light frosts do not injure the leaves so that the turf holds its

green color well into the winter. Most northern perennial grasses are planted with seed rather than with vegetative material.

15-5.3.2.1. Bent grass (*Agrostis spp.*). Bent grasses are used extensively for golf greens wherever climatic conditions permit (fig. 15-1 (8)). Colonial and velvet bent grasses are planted with seed; creeping bent grass is planted with stolons. Many superior strains and varieties have been developed. This manual does not attempt to evaluate these strains, since local conditions determine the ones that are best adapted. When bent grass is included in a lawn mixture, the species tends to dominate in those sections receiving considerable irrigation, where the soil is relatively acid (pH under 5.0), and where the turf is closely mowed. For this reason the species is not recommended for lawn mixtures. Bent grass is excellent in a mixture with bluegrass and redtop on waterway banks in the Northern tier States, clothing them to the water's edge but not invading shallow water.

15-5.3.2.2. Bluegrass, Canada (*Poa compressa*) (fig. 15-1(16)). Mention is made here of this grass since it is frequently confused with Kentucky bluegrass in military specifications. It forms an open sod, persisting on low-fertility soils in the Northern States after other species have failed. The plant has some value on sandy soils near the Great Lakes, on road-banks, and on other low-maintenance areas. The red fescues are equal or superior to it on most sites but not on slopes with a southern exposure where soil surface temperatures become lethal for the fescues.

15-5.3.2.3. Bluegrass, Kentucky (*Poa pratensis*) (fig. 15-1(1)). This is the most commonly used grass for turf, on lawns, athletic fields, airfields and miscellaneous areas. Its natural range is throughout the cool-humid region, but where irrigation is provided it is successfully planted in the northern two-thirds of the United States. In semi-arid areas it may survive only where shaded. The optimum soil temperatures for root growth lay between 55 and 73 degrees Fahrenheit. Bluegrass stops growing and goes dormant when soil temperatures reach 80 degrees or above. It is best to soils derived from limestone but is satisfactory on heavy soils if fertility is adequate. It is sensitive to soil salt and may not persist where the soil pH is less than 5.0. Planted with seed, it spreads underground by short rhizomes. Since it is sensitive to close mowing, do not cut to less than 2 inches. Under close mowing it is subject to invasion by annual bluegrass. When growth slows in summer, increase the

mowing height. Lower mowing height at the last fall cut to avoid matting and snow mold in the snow belt. Many varieties have been developed and released: "Cougar" for the northwest; "Fylking" from Sweden for low mowing, "Park" for northern tier states from Minnesota; "Kenblue" from native stands in Kentucky. "Merion," released by the U.S. Golf Association and the U.S.D.A., is best mixed with common for overall satisfactory performance since it is subject to several diseases in the warmer areas. Most bluegrass plantings are mixtures with other cool-season sod-forming grasses. Use locally proven varieties.

15-5.3.24. *Red and Chewings fescue (Festuca rubra)*. Chewings fescue and red fescue are strains of the same species and are used in the same climatic zones (fig. 15-1(3)). Mix with other grasses to provide a more dense and continuous turf. It endures shade better than Kentucky bluegrass and persists better on highly acid soils in areas where both are adapted. This species is widely used in commercial mixes, but there is little evidence that the fescues are useful in planting mixtures outside the limits indicated on the adaptation map. For partial shade a mixture of 50 percent creeping red fescue (Pennlawn, Illahee, Trinity or common) and Kentucky bluegrass (common or Merion) is quite generally satisfactory. For heavy shade the creeping red fescue should be increased to 55 to 65 percent.

15-5.3.2.5. *Orchard grass (Dactylis glomerata)*. This species fills essentially the same position for hay and pasture in the Central and Eastern States as does brome grass in the cornbelt. In mixtures with legumes, orchard grass is of value for western irrigated pastures. It is a bunch grass, is leafy and palatable to livestock, and grows well both in shade and in the open. It will survive south of the area shown in figure 16-1(18), but there are other grasses better adapted to those areas. Do not use for lawns and physical training areas. It lacks durability under traffic and tends to form widely spaced bunches.

15-5.3.2.6. *Redtop (Agrostis alba)*. Redtop is not usually planted by itself. This is a bunch grass and is planted by means of seed. Its principal value is for roadside planting and erosion control (fig. 15-1(14)). Exclude it from seed mixtures used for improved lawns because of the bunchy, open-type turf that it develops. It is also being used for overseeding Bermuda grass golf greens in the fall for winter cover. Transition from redtop to Bermuda in the spring occurs gradually without interruption for play.

15-5.3.2. 7. *Rye grasses (Lolium spp.)*. These grasses include various species and strains that are not well marked by distinguishing characteristics and habits. The

two most common types are perennial rye grass and domestic Italian or annual rye grass. Both types are perennial under certain climatic conditions and both are annual under others. The higher prices for perennial rye grass are not justified except in the Northeastern and Northwestern States (or other locations), where the species is truly perennial. Rye grasses in general do not have a specific range of adaptation, and their use varies with geographical location. Lawns are planted with rye grass in the South to obtain winter color, but this is not advocated for military installations except for golf greens and tees. The brown, winter color of Bermuda grass and other southern lawn grasses is not objectionable. Rye grass is often combined with lawn seed mixtures, but such mixtures should be restricted to zone 1 (fig. 15-2).

15-5.3.28. *Smooth brome grass (Bromus inermis)*. Although this grass is widely adapted, its principal value is in the cornbelt and adjacent sections to the north and northwest (fig. 15-1 (7)). It is widely used for pasture, hay, and erosion control. The grass spreads by rhizomes and develops a tough sod where soils are fertile. It is not recommended for lawns because of its wide blades and open turf growth. Seed sources are important for the species. Use northern sources for northern plantings and midwestern sources for southern parts of the brome grass range.

15-5.3.2.9. *Tall fescue (Festuca elatior var, arundinacea)*. The Goar strain of tall fescue is especially well adapted to the Southwestern States. The Kentucky 31 strain is preferred for eastern conditions and the alta and Goar strains for western areas. Follow the adaptation map (fig. 15-1 (6)) pending development of more accurate information. The species is aggressive and drought resistant for the area to which it is adapted and is valuable for erosion control. The grass is wide-bladed and has a bunch growth habit, but tends to become finer-bladed under mowing. It is suitable for pastures, ball fields, airfields, and similar areas and is satisfactory for open areas adjacent to lawns. It may be substituted for Kentucky bluegrass on lawns where bluegrass does not thrive (e.g. sandy soils) typical of the southern border of the bluegrass adaptation zone in Kansas and eastward. Use tall fescue on lawns unmixed with other species. The species may be mixed with bluegrass for other than lawn purposes, but the percentage of bluegrass seed in the mixture should not

be more than 10 percent of the total.

15-5.3.2.10. Timothy (*Phleum pratense*). Timothy is a bunch grass that is adapted to the Northeastern States. Its principal use is for hay, but it is also valuable in pasture mixtures. In addition to the area shown in the adaption map (fig. 15-1 (17)), timothy is used locally in mountain valleys at high altitudes in the Western States. Exclude timothy from seed mixture for improved lawns.

15-5.3.3. Drought resistant perennial grasses. Many species of drought resistant grasses are available in arid zones for vegetative cover and erosion control. Most of these are native species, some of which may not be available commercially. Determine availability of seed supplies from local representatives of the U.S. Department of Agriculture before listing them in Army specification.

15-5.3.3.1. Black grama grass (*Bouteloua eriopoda*). Black grama grass is a southern plains and desert bunch grass (fig. 15-1 (17)) reproducing by seed only. Principal uses are for erosion control and air- fields. Seed supplies may not be commercially available, and mature hay may be used from local range lands.

15-5.3.3.2. Blue grama grass (*Bouteloua gracilis*). Blue grama is a native grass adapted to the semi-arid and subhumid plains and intermountain States. It is a natural companion to buffalo grass over much of its range (fig. 15-1 (14)). Blue grama is more capable than buffalo grass of surviving on more arid, sandier, and shallower soils and therefore will dominate it in such areas. Buffalo grass will usually dominate on the deeper or clay loam soils. Blue grama is useful for pastures, lawns and where intensive maintenance is unnecessary. Over the southern parts of its range of adaptation, it is a typical bunch grass. At higher elevations and in the northern part of its range it tends to spread by short rhizomes and develops large irregular patches of turf similar to those of buffalo grass. Blue grama is established by seeds. Plant in a crop residue of wheat, Sudan grass, or similar material, or mulch the area with hay or straw. The seedlings become established slowly, and require protection from drying winds. Seed source is important. Do not use northern-grown seed in southern latitudes or southern-grown seed in northern latitudes.

15-5.3.3.3. Buffalo grass (*Buchloe dactyloides*). Buffalo grass is abundant over the subhumid and semi-arid prairies and plains from Texas to North Dakota (fig. 15-1 (12)). Preserve native buffalo grass turf where possible because reestablishing this grass is often difficult and slow. Buffalo grass is an excellent pasture grass,

spreading by stolons to develop a dense compact turf. Although it is suitable for improved lawns, other grasses are more durable and are superior to it for most lawn conditions. Blue grama is a natural companion of buffalo grass in most areas and is included in seed mixtures for erosion control. Buffalo grass is planted by spot sodding with squares or plugs set level with the surface of the seedbed, or started from treated seed. Plantings are covered with mulch to prevent wind damage and to conserve moisture at the surface of the soil, since the seedlings are slow to become established. Irrigation of newly planted plugs is usually necessary. For large unimproved areas, planted mulches developed by growing Sudan grass or sorghums are preferred to applied mulches because of cost.

15-5.3.3.4. Bluebunch wheat grass (*Agropyron spicatum*). This is a native bunch grass, adapted to the northwestern plains (fig. 15-1 (11)). Planting is by seed only. Principal uses are for erosion control and airfields. Do not use on improved grounds. Intermediate wheat grass is a similar introduced species and should be used only upon the advice of technicians familiar with local planting conditions. There are also other wheat grass species and varieties having similar habits of growth that may be substituted.

15-5.3.3.5. Crested wheat grass (*Agropyron desertorum* and *A. cristatum*). This grass is adapted for hay but is used primarily for pasture. Crested wheat grass is a bunch grass and develops a rather open turf which is not suitable for lawns. It can be planted advantageously for erosion control in building areas where lawns are not necessary. Because of the high wind velocities common to the area of its adaptation (fig. 15-1 (5)), it is usually planted into the residual stubble of some cereal grain such as wheat, if fall planted, or into residual stubble of Sudan grass, sorghum, or millet, if spring planted. This grass is one of the more valuable grasses for northern semi-arid areas and is widely utilized at Army installations for grazing, dust and erosion control, and unimproved grounds. The common variety (*A. desertorum*) is preferred to the fairway variety (*A. cristatum*) for most plantings.

15-5.3.3.6. Galleta grass (*Hilaria jamesii*). This is a high plains (fig. 15-1 (15)), native grass, reproducing by seed and rhizomes. Planting is by seed only. Principal uses are for erosion control on unimproved grounds including ammunition storage areas and airfields. Do not use on improved grounds. Seed supplies may not be commercially available, and mature hay from local range

lands may be used. A similar species, tobosa grass (*Hilaria mutica*), may be substituted for galleta where the plant occurs nearby in native range lands.

15-5.3.3.7. *Indian rice grass (Oryzopsis hymenoides)*. This is a desert and intermountain bunch grass (fig. 15-1 (13)), reproducing by seed only. Principal use is for erosion control on unimproved grounds. Do not use on improved grounds. The species survives on sandy soils better than most grasses and is used also on barren or rocky soils where other species do not thrive.

15-5.3.3.8. *Little bluestem (Andropogon scoparius)*. This is a native prairie bunch grass (fig. 15-1 (13)), reproducing by seed only. Principal uses are for erosion control and airfields on unimproved grounds such as ammunition storage areas. Do not use on improved grounds. It survives on sandy, barren lands where cultivated species do not thrive.

15-5.3.3.9. *Love Grass (Eragrostis spp)*. Sand love grass (*E. trichodes*) is valuable for the stabilization of sandy soils in western Oklahoma and Kansas. Weeping love grass (*E. curvula*) is adapted to about the same areas as Bermuda grass. Its special area of use is on sterile excavated or eroded soils in the Atlantic Coast and Gulf States which will receive little or no maintenance or fertilization. Lehmann (*E. lehmanniana*) and Boer (*E. chloromelas*) love grasses are used for erosion control in southern Arizona and New Mexico deserts where storm runoff provides additional soil moisture. These love grasses are bunch grasses and are established from seed. They exhibit strong seedling vigor and for this reason are easily established. They generally do not persist in competition with native grasses and shrubs but stabilize unimproved grounds temporarily until more permanent plants crowd them out.

15-5.3.3.10. *Sand dropseed (Sporobolus cryptandrus)*. This is a bunch grass native to the plains, prairies, and intermountain region (fig. 15-1 (16)). Planting is by seed only. Principal use is for erosion control on barren, stony, or sandy sites, where other species do not thrive. Mixing the species with blue grama is a common practice, since the two species have similar areas of adaptation. Do not use the species on improved grounds.

15-5.3.3.11. *Side-oats grama (Bouteloua curtipendula)*. This is a bunch grass common in the plains and prairie areas (fig. 5-1(9)). Planting is by seed only. Principal use is in mixtures for erosion control on slopes. Do not use on improved grounds.

Seed source is important. Do not use northern-grown seed in southern latitudes or southern-grown seed in northern latitudes.

15-5.3.3.12. *Western wheat grass (Agropyron smithii)*. This grass is a native species adapted over an area

similar to that of crested wheat grass (fig. 15-1(10)). The grass spreads by rhizomes, and does not make a dense turf. It is not as drought resistant as crested wheat grass and for this reason is not recommended for agricultural plantings where crested wheat grass may be used. It has some value in large open areas of Army installations. It is especially useful for grassed waterways.

15-5.3.4. *Temporary or annual grasses.*

15-5.3.4.1. *Annual brome grasses (Bromus spp.)* are cool-season, fall-planted, annual bunch grasses used for airfields and erosion control in Pacific Coast States where perennial grasses do not survive the dry summers. Chess and cheat are also names given to this group of grasses. Planting is by seed only. Pastures and cultivated areas are often dominated by these grasses. Seed supplies are not always available commercially so that planting may require the use of mature, hay, obtained from local uncultivated areas. Blando, a variety of *Bromus mollis*, is one variety selected for its superiority to most naturalized common varieties (fig. 15-1(16)).

15-5.3.4.2. *Annual rye grass (Lolium multiflorum)* is a cool-season bunch grass, widely adapted for temporary or emergency plantings for erosion control, or as a companion or cover crop. Planting is by seed only, usually during the fall or early spring. The species is also called Italian rye grass and domestic rye grass. See also paragraph 15-5.3.2.7.

15-5.3.4.3. *Cereal grains* are fall- or early springplanted species, widely used for erosion control and for emergency cover crops where applied mulches are impractical. Barley (*Hordeum vulgare*), rye (*Secale cereale*), oats (*Avena sativa*), and wheat (*Triticum aestivum*) are typical. Planting is by seed only.

15-5.3.4.4. *Sorghum (Sorghum vulgare)* is a warm-season, spring- or summer-planted crop used in agriculture for forage and grain. The species, in its many forms, may be used for erosion control and emergency cover crop where applied mulches are impractical. For agricultural purposes, the crop is normally planted in rows, but when used as a planted mulch, plant with a grain drill as for cereal grains. 15-5.3.4.5. Sudan grass (*Sorghum sudanense*) is a warm-season, spring-or summer-planted bunch grass, widely used for erosion control and emergency cover crops where applied mulches are impractical. Permanent grasses may then

be planted into the dead vegetative residue after Sudan grass has matured.

15-5.3.5. *Miscellaneous grasses.* See paragraph 7-4, Sand Dune Control, for miscellaneous grasses (some described above) used for stabilization of sandy areas. Beach grasses (not described above) are important stabilizers. The following information is appropriate:

15-5.3.5.1. *Beach grass, American (Ammophila breviligulata).* American beach grass is a native rhizomatous perennial along the Atlantic Coast and the Great Lakes; it is used extensively in the East as a primary stabilizer for lakeshore and coastal sand dunes. Plant clumps of three to five stems, from 8 to 12 inches deep on 2-foot staggered centers. It responds for 2 to 3 years to an initial application of slow release magnesium-ammonium-phosphate fertilizer placed under or at the side of the plants. Hand planting and mechanical planters are used. Stock is available from commercial nurseries. Some stock can be secured by thinning native stands. Dipping in a mud slurry immediately prior to planting often increases survival percentage of late spring plantings. (See para. 7-4, sand dune control.)

15-5.3.5.2. *Beach grass, European (Ammophila arenaria).* This naturalized grass is less rhizomatous and more sensitive to high temperatures immediately after transplant than American beach grass, but is preferred on Pacific Coastal dunes. Nursery-produced stock is used. Depth of planting and spacing is the same as for American beach grass. For new plantings on active coastal dunes 60 pounds of nitrogen, preferably ammonium sulphate, is recommended. The best time to apply is late winter or very early spring before new shoots appear.

15-5.3.6. *Miscellaneous legumes.* Legumes are valuable supplements to grasses for erosion control and are usually used in mixtures with grasses.

15-5.3.6.1. *Clovers.* There are many species of clovers commonly used in mixtures with bluegrass and Bermuda grass. Alsike clover (*Trifolium hybridum*) and white clover (*Trifolium repens*) have value in mixtures of cool season grasses (fig. 15-1(9) and 15-1(15)) for erosion control on unimproved grounds and embankments. These are not normally of value in improved lawns and should not be included in mixtures for athletic fields. Both species are perennial but are short lived and rely on seed for continuing persistence in the planted mixture. Hop clovers (*Trifolium agrarium*, *camestrum*, and other species), and bur clovers (*Medicago arabica*, *hispida*, and other species) are frequent natural mixers in Bermuda, carpet, and other southern pastures and grasslands. AU are objectionable in lawns and athletic

fields but are of some value for erosion control on unimproved grounds. They are low-growing, mostly annual plants which produce abundant seed supplies. Sweet clovers (*Melilotus species*) are winter annual or biennial species used principally for a temporary cover crop or pasture or to build up the soil preparatory to permanent plantings. Sweet clovers are tall, stemmy plants and are not generally useful on military installations except as a part of an agricultural leasing program.

15-5.3.6.2. *Lespedezas.* There are two general types of lespedezas; low annuals typical of common lespedeza (*Lespedeza striata*) and Korean lespedeza (*L. stipulacae*), and the perennial types of which sericea lespedeza (*L. cuneata*) is typical. Lespedezas are used principally for erosion control and wildlife food in the Southeastern United States (fig. 15-1(12)). Sericea lespedeza is used effectively on slopes which are too steep to mow. Grasses are normally better adapted to mowed slopes. Various species of shrubby lespedezas are valuable in the Southeastern States for quail food plots (e.g. *L. bicolor* and *L. japonica*).

Note; See paragraph 15-6.6 and table 15-3 for ground cover plants which include another legume (Crown vetch) for soil erosion control on areas too steep to mow.

15-5.4. *Planting Zones.* The areas recommended for the individual species are illustrated in figures 15-1. These maps do not delineate areas on which the various species are known to survive or where they may occur naturally, but rather represent areas where their use in new plantings is desirable. Do not use a species outside the area recommended except on the advice of a turf specialist familiar with the specific problem area and its intended military use. The selection of species provided in the following paragraphs of this section must be adjusted to local conditions of soil, slope, and climate. In figure 15-2, the United States is divided into seven planting zones to provide a convenient grouping of treatments countrywide. The map has been designed primarily for selection of species for improved grounds and recreational areas. To avoid numerous zone maps, the same map is used herein for all grass and ground cover plantings. In general, zone 2 represents an area where Kentucky bluegrass, unmixed with other species, is used on lawns. Zone 6, in general, represents an area where Bermuda grass may be used unmixed with other species. Zones 1 and 3 represent areas where chewings

or red fescue is of value in the turf mixture. Perennial rye grass is a common component in turf in zone 1 but not in zone 3. The northern edge of zone 4 represents, in general, the northern limit for Bermuda grass and the southern edge is approximately the southern limit for Kentucky bluegrass. The northern edge of zone 5 represents, in general, the northern limit for other southern grasses: St. Augustine, centipede, and Pensacola bahia. Zone 7 represents an area where such plants as iceplant and kikuyu may be used as well as other adapted species.

15-5.5. Lawn-Type Plantings. Plantings in this category are intended for lawns, cemeteries, and adjacent areas where foot traffic is light or infrequent. It is anticipated that irrigation is available in most areas of these plantings where 30 inches or less average annual rainfall occurs and on other sites which must be watered to sustain adequate growth.

15-5.5.1. Planting zone 1. Use 40 percent Kentucky bluegrass, 40 percent chewings or red fescue and 20 percent perennial rye grass.

15-5.5.2. Planting zone 2. Use Kentucky bluegrass unmixed with other species with the following exceptions:

15-5.5.2.1. Along the southern edge of the zone on sites where bluegrass does not thrive (slopes facing south or west, in sandy or stony soils), use tall fescue (Kentucky 31 or alta) or U-3 Bermuda grass (or other improved strain). Meyer Zoysia may be substituted for Bermuda grass in Illinois and eastward.

15-5.5.2.2. In deep shade in Indiana and eastward, especially on the north side of buildings, use 25 percent Kentucky bluegrass and 75 percent chewings or red fescue.

15-5.5.2.3. West of the 97th meridian where irrigation is impractical, use crested wheat grass, buffalo, and blue grama within the areas of recommended use (fig. 15-1 (5), (12), and (14)). In areas where these grasses do not survive because of low rainfall, use a 1- to 2-inch blanket of crushed rock or gravel aggregate graded as follows:

Passing 1 1/2-inch sieve-100 percent

Passing 1-inch sieve-60-90 percent

Passing 1/4-inch sieve-0-20 percent

15-5.5.3. Planting zone 3. On clay loam or silt loam soils with good depth, use a 50-50 mixture of Kentucky bluegrass and chewings or red fescue. On sandy loam or shallow soils, especially those which will not be maintained under high-fertility conditions, use 30 percent Kentucky bluegrass and 70 percent chewings or red fescue. Improved strains of these grasses may be available.

15-5.5.4. Planting zone 4. Use U-3 Bermuda grass or other adapted, lawn-type improved strain east of the 96th meridian and common Bermuda west of the 96th meridian. Do not use fine-leaved types intended for golf greens or coarse pasture types (e.g. Coastal). Observe the following exceptions:

15-5.5.4.1. For shady areas or deep clay loam soils, use Kentucky bluegrass in localities where the species is in general use. For lawn areas with heavy shade, rye grass may be required to be planted each fall.

15-5.5.4.2. For areas on which irrigation is not practical in central Oklahoma and Texas within the zone, use a 50-50 mixture of buffalo and blue grama grasses.

15-5.5.5. Planting zone 5. Use Bermuda grass, centipede grass, Zoysia, or St. Augustine grass, depending on conditions of shade and sun and local evaluation. Use improved strains of Bermuda and Zoysia grasses upon advice of technicians having a knowledge of local requirements. In the absence of other local requirements, use Tiflawn or Sunturf Bermuda in the open sun; Manila grass (matrella) or Meyer in semishade; and centipede or St. Augustine in shade. Do not use the fine-leaved Bermuda grass intended for golf greens or the coarse-leaved types, such as the Coastal variety.

15-5.5.6. Planting zone 6. Use Bermuda grass unmixed with other species. The common strain is acceptable for most sites. Use improved varieties where technical advice on special requirements is available. Avoid the fine-leaved strains intended for golf greens and the coarse pasture types (Coastal Bermuda). In shady situations and in high altitudes (6,000 feet or over) where Bermuda grass does not thrive, use Kentucky bluegrass or perennial rye grass.

15-5.5.7. Planting zone 7. Use Bermuda grass on typical open sites. The U-3 strain is preferred for most conditions. In shady situations or in high altitudes where Bermuda grass does not thrive, use Kentucky bluegrass or perennial rye grass. On slopes adjacent to lawns, which may not be irrigated but are part of the improved grounds, use iceplant or kikuyu grass.

15-5.5.8. Planting zone, Alaska. Use improved strains of Kentucky bluegrass.

15-5.5.9. Planting zone, Hawaii. Use common, locally available strains of Bermuda grass in the open sun and

St. Augustine, centipede, or Manila grass in shady situations.

15-5.5.10. *Planting zone, Caribbean.* Use Tiflawn or common Bermuda grasses. Manila grass may be substituted on sites where established planting indicates it will survive, especially for small, highly improved lawns. Unless fertilized and irrigated, other grasses such as hurricane grass (*Andropogon pertusus*) will replace Bermuda grass in the Canal Zone. These local species are not objectionable but seed supplies are not available commercially.

15-5.6. *Recreational Areas and Parade Grounds.* Plantings in this category are intended to be used for ball fields, parade grounds, children's play-grounds, and similar areas where heavy foot traffic is expected. It is anticipated that irrigation facilities will be available for such areas where needed (para. 16-3).

15-5.6.1. *Planting zone 1.* Use Alta fescue or a 50-50 mixture of Kentucky bluegrass and perennial rye grass.

15-5.6.2. *Planting zone 2.* Use Kentucky bluegrass unmixed with other species. South of latitude 40, substitute tall fescue (Kentucky 31 or Alta) on sandy loam soils.

15-5.6.3. *Planting zone 3.* Use a 50-50 mixture of Kentucky bluegrass and chewings or red fescue.

15-5.6.4. *Planting zones 4, 5, 6, and 7.* Use Bermuda grass. East of the 97th meridian and in zone 7, use improved selections such as U-3 or Tiflawn. Substitute tall fescue (Kentucky 31 or Alta) in zone 4 where heavy fall and winter use is expected. In high altitudes (5000 ft or more) substitute Kentucky Bluegrass or perennial rye grass.

15-5.6.5. *Planting zone, Hawaii.* Use locally Bermuda available fine-leaved strains of common Bermuda grass.

15-5.6.6. *Planting zone, Alaska.* Use improved strains of Kentucky bluegrass.

15-5.6.7. *Planting zone, Caribbean.* Use improved selections of Bermuda grass, e.g., Tiflawn.

15-5.7. *Airfields.* Plantings in this category are intended to be used for soil stabilization and cover to prevent dust and water erosion on airfields. Where turf is to be used for the landing of aircraft, select grasses in the zones of adaptation that will withstand traffic. Unless otherwise noted, it is anticipated that irrigation will not be available for plantings for airfields.

15-5.7.1. *Planting zone 1.* Use tall fescue north of latitude 40 within the zone, and Blando brome grass or Harding grass south of latitude 40.

15-5.7.2. *Planting zone 2.* Use Kentucky bluegrass east of the 97th meridian within the zone, and crested wheat grass in the remainder of the zone, observing the following exceptions:

15-5.7.2.1. Within the ranges of their recommended use (figs. 15-1 (12) and (14)) on silt loam and clay loams, a 75-25 mixture of blue grama and buffalo grasses may be substituted for crested wheat grass. On sands and sandy loams within the range of their recommended use (figs. 15-1(14) and (16)), use a 75-25 mixture of blue grama and sand dropseed grasses.

15-5.7.2.2. On sandy loam softs, use smooth brome grass within the range of its recommended use (fig. 15-1(7)).

15-5.7.2.3. In low rainfall areas (approximately 10 inches and less) or other sites where grasses do not thrive, do not use turf; instead use a 1- to 2-inch blanket of crushed rock or gravel aggregate as specified in paragraph 15-5.5.2.3. If irrigation is practical in these low rainfall areas, use Kentucky bluegrass or crested wheat grass.

15-5.7.3. *Planting zone 3.* Use a 50-50 mixture of Kentucky bluegrass and chewings fescue. On sandy or shallow soils, especially those which will not be maintained under high fertility conditions, use 30 percent Kentucky bluegrass and 70 percent chewings fescue.

15-5.7.4. *Planting zones 4 and 6.*

15-5.7.4.1. East of the 98th meridian, use common Bermuda grass.

15-5.7.4.2. West of the 98th meridian, use common Bermuda grass where irrigation is practicable. Otherwise, use native species such as buffalo, blue grama, black grama, galleta, and sand dropseed grasses within areas of recommended use. Use crested wheat grass in elevations over 4000 feet. Where average annual rainfall is less than 10 inches, and on other sites where grasses do not thrive, use crushed rock or gravel aggregate as specified in paragraph 15-5.5.2.3.

15-5.7.5. *Planting zone 5.* Use Pensacola bahia within the range of its recommended use (fig. 15-1(9)) and Bermuda grass elsewhere within the zone.

15-5.7.6. *Planting Zone 7.* Use Harding grass or Blando brome grass. Do not use Harding grass where average

annual rainfall is less than 15 inches.

15-5.7.7. Planting zone, Alaska. Use smooth brome grass from Northern United States or Canada seed sources, or improved strains of red fescue.

15-5.7.7. Planting zone, Hawaii. Use common Bermuda grass. In areas of low rainfall where Bermuda grass does not survive, use a light covering of gravel or aggregate to prevent soil erosion until native covering of gravel or aggregate to prevent soil erosion until native plants volunteer and stabilize the area. Avoid the use of aggregate adjacent to run ways, taxiways, and parking aprons.

15-5.7.9. Planting zone, Caribbean. Use Pensacola bahia grass, or common Bermuda grass.

15-5.8. Ammunition Magazines, Embankments, Field Training Areas, and Antenna Fields. Vegetative and aggregate cover on ammunition storage magazines, barricades, roadside and other embankments, and similar sites is intended to control dust and water erosion. It is anticipated that irrigation will not be available for these plantings. (For additional information on wind and water erosion control see chap. 7).

15-5.8.1. Planting zone 1. Use alta fescue north of latitude 40, and native annual brome grasses (e.g., Blando brome) or annual rye grass south of latitude 40 within the zone.

15-5.8.2. Planting zone 2.

15-5.8.2.1. In Illinois and eastward within the zone, use tall fescue (Kentucky 31 or Alta). Japanese honeysuckle may be substituted for tall fescue south of latitude 40.

15-5.8.2.2. In Iowa, Missouri, and Minnesota, within the zone, and westward to the 98th meridian, use smooth brome grass.

15-5.8.2.3. North of latitude 40 and west of the 98th meridian within the zone, use a 2-inch cover of crushed rock or gravel aggregate or basaltic rock, limestone, conglomerate granite, or other similar materials which are resistant to disintegration upon weathering, graded:

 Passing 1-inch sieve-100 percent

 Passing 3/4-inch sieve-60-90 percent

 Passing 1/4-inch sieve-0-20 percent

The above grades apply to ammunition storage magazines. For other than such magazines use grades prescribed in paragraph 15-5.5.2.3. Crested wheat grass and blue grama may be substituted for aggregate where high altitudes (4000 feet or more) permit these species to persist.

15-5.8.3. Planting zone 3. Use a mixture containing 30 percent Kentucky bluegrass, 50 percent chewings

fescue, 10 percent redtop, and 10 percent alsike clover.

15-8.4. Planting zones 4, 6, and 7.

15-5.8.4.1. East of the 98th meridian within these zones use common Bermuda grass. Tall fescue may be substituted on silt loam or clay loam soils within its area of recommended use (fig. 15-1(6)).

15-5.8.4.2. West of the 98th meridian in Oklahoma and Texas, use King Ranch bluestem, blue grama, and buffalo grasses within their respective areas of recommended use (fig. 15-1(18), (14) and (12)) where experience indicates they will survive on both favorable and unfavorable slopes of earth barricades. Otherwise, in areas west of the 98th meridian, use crushed rock or gravel as specified in paragraph 5-5.8.2.3.

15-5.8.5. Planting zone 5. Use Centipede grass on Pensacola bahia within their areas of recommended use (fig. 15-1 (5) and (9)) and common Bermuda in the remainder of the zone.

15-5.8.6. Planting zone, Alaska. Use smooth brome where the- to 2-inch layer of crushed rock or gravel aggregate as specified in paragraph 15-5.8.2.3.

15-5.8.7. Planting zone, Hawaii. Climatic zones are extremely variable. Use Kikuyu grass or other locally adapted grass species. In low rainfall zones where grasses do not survive, use crushed rock as prescribed in paragraph 5-5.8.2.3.

15-5.8.8. Planting zone, Caribbean. Use common Bermuda grass.

15-5.9. Unimproved Grounds. Plantings in this category are intended to be used principally for the control of dust and soil erosion where the area is used for infrequent troop training, bivouac, and similar purposes. Included also are plantings for watershed improvement, firebreaks, and utility rights of way. It is anticipated that irrigation will not be available in these areas (For additional information on wind and water erosion control see chap. 7).

15-5.9.1. Planting zone 1. Use Alta fescue north of latitude 40, and annual brome grasses or annual rye grass south of latitude 40 within the zone (e.g., Blando brome).

15-5.9.2. Planting zone 2.

15-5.9.2.1. In Illinois and eastward within the zone use Kentucky bluegrass. On sandy loam soils, substitute Kentucky 31 fescue.

15-5.9.2.2. In Iowa, Missouri, and Minnesota within the zone, and westward to the 98th meridian, use smooth brome grass.

15-5.9.2.3. North of latitude 40 and west of the 98th meridian on productive loam soils, use crested wheat grass.

15-5.9.2.4. On unproductive (shallow, sandy, heavy clay) soils west of the 98th meridian, use locally adapted native species. Refer to figure 15-1 for recommended use areas for Crested Wheat grass (5), Western Wheat grass (10), Buffalo grass (12), Little Bluestem (13), Indian Rice grass (13), galleta (15), and sand dropseed (16).

15-5.9.3. *Planting zone 3.* Use a 50-50 mixture of Kentucky bluegrass and chewings fescue. On sandy or shallow soils use 30 percent Kentucky bluegrass and 70 percent chewings fescue.

15-5.9.4. *Planting zones 4 and 6.*

15-5.9.4.1. East of the 97th meridian, use common Bermuda grass. Korean lespedeza or other annual species of lespedeza within their range of recommended use (fig. 15-1 (12)) may be substituted on waste areas for erosion control.

15-5.9.4.2. From the 97th meridian, west to the 104th: In zone 4, use a mixture of 70 percent blue grama, 15 percent buffalo, and 15 percent sand dropseed grasses; in zone 6, use King Ranch bluestem within its range of recommended use (fig. 15-1 (18)), or similar species of Asiatic bluestems or the mixture prescribed above for zone 4.

15-5.9.4.3. West of the 104th meridian, use black grama, sand dropseed, gaueta, Indian rice grass, and other

native species that are available within their areas of recommended use (fig. 15-1 (17), (16), (15) and (13)). In desert areas of low rainfall (less than 10 inches annually), a light covering of ungraded gravel or other aggregate may be used to prevent soil erosion until native species of shrubs, grasses, and other plants volunteer and stabilize the area. Small areas not subject to traffic may be stabilized by sprinkling with water from a water truck to form a crust until native vegetation becomes established.

15-5.9.5. *Planting zone 5.* Use Pensacola bahia within its area of recommended use (fig. 15-1 (9)) and Bermuda grass elsewhere. Korean lespedeza and other annual lespedeza varieties and weeping lovegrass may be substituted on waste areas and sterile subsoils for erosion control.

15-5.9.6. *Planting zone 7.* Use native annual brome grasses from mature hay obtained from uncultivated areas, Blando brome, or annual rye grass.

15-5.9.7. *Planting zone, Alaska.* Use smooth brome grass from northern United States and Canada seed sources.

15-5.9.8. *Planting zone, Hawaii.* Climatic zones are extremely variable. Bermuda grass or Kikuyu grass may be used in most zones. In low rainfall zones where grasses do not survive use rock aggregate as prescribed in paragraph 15-5.5.2.3.

15-5.9.9. *Planting zone, Caribbean.* Use common Bermuda grass or Pensacola bahia grass.

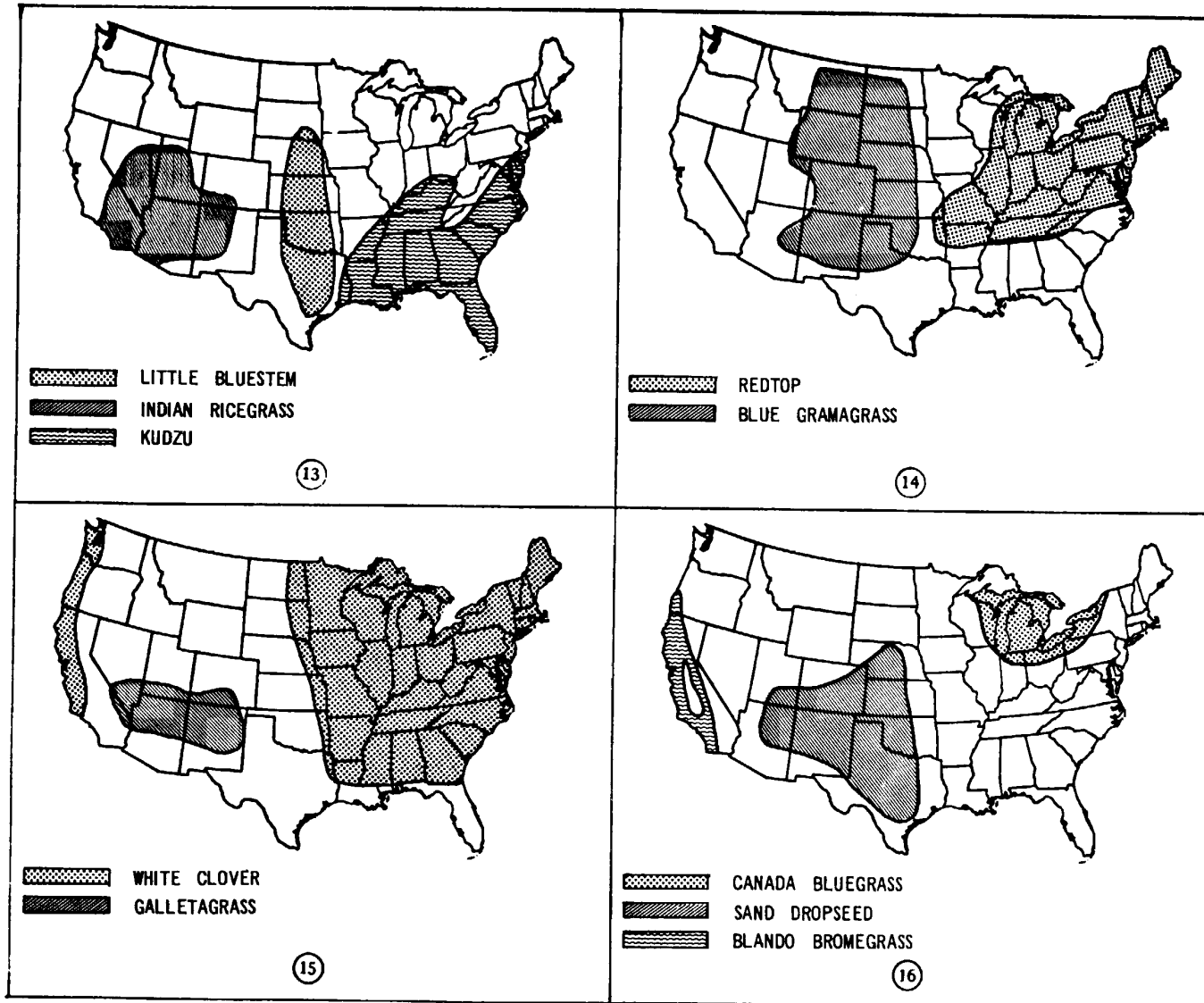

Figure 15-1. Zones of adaptation for grasses.

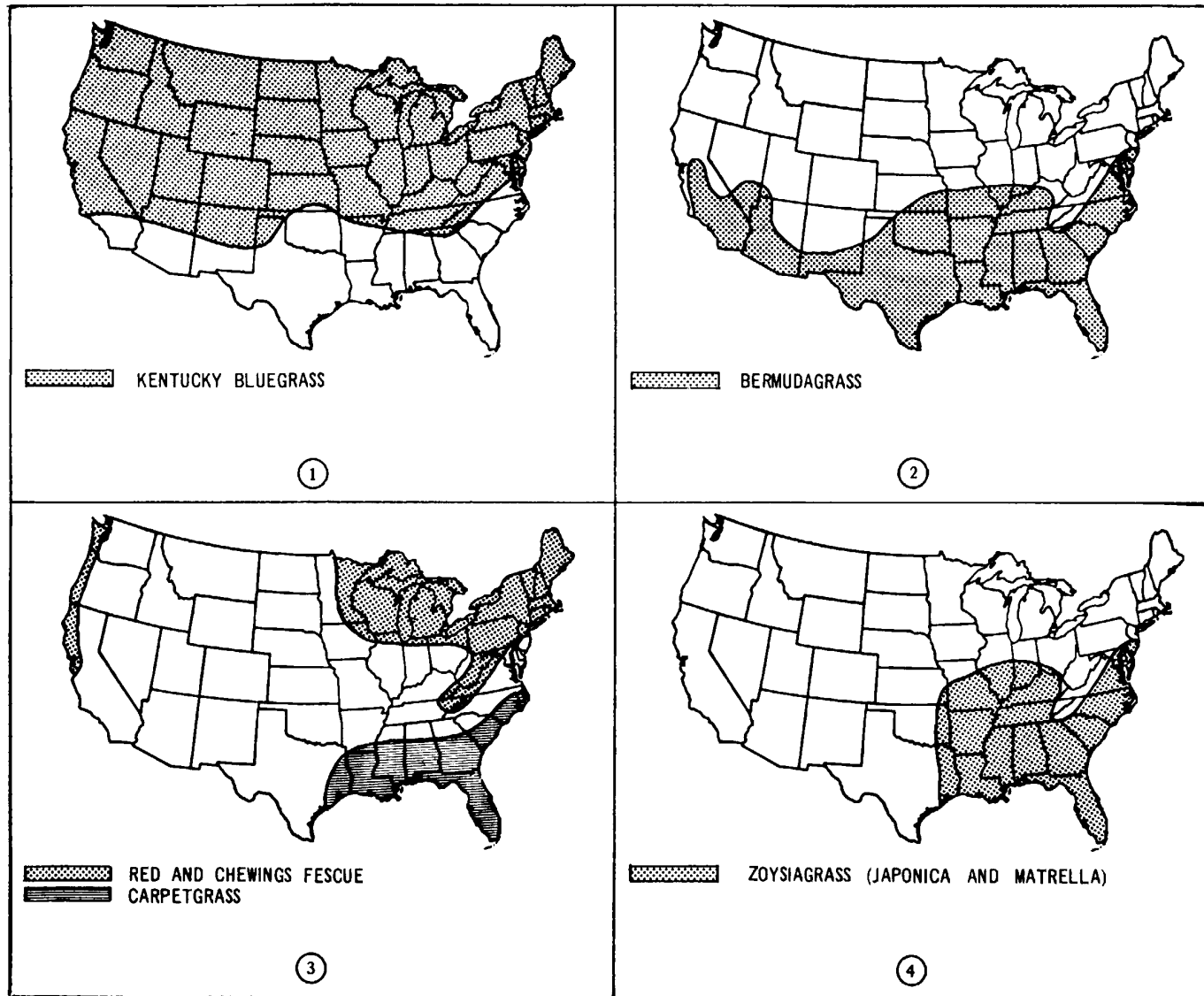

Figure 15-1. Continued.

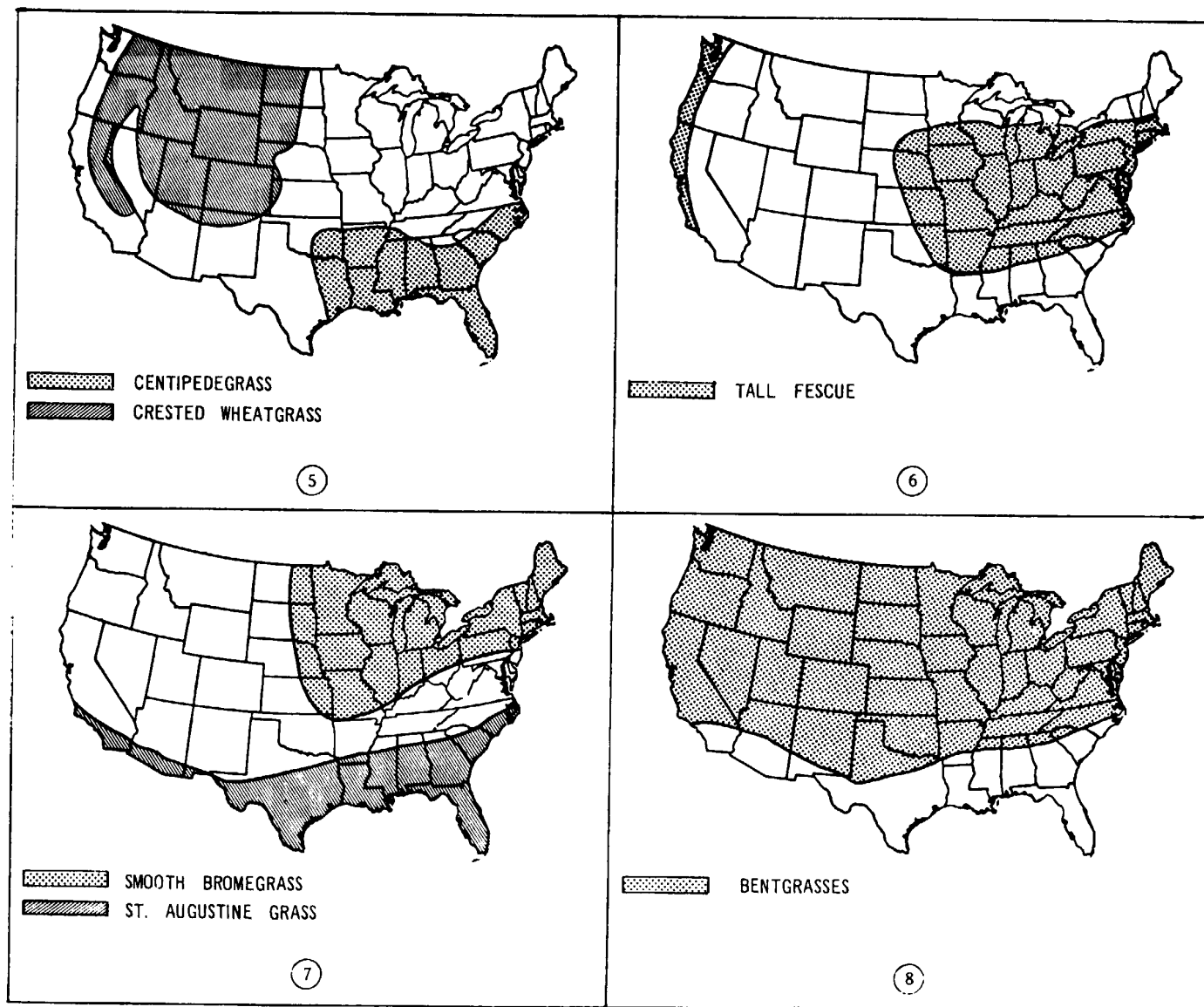

Figure 15-1. Continued

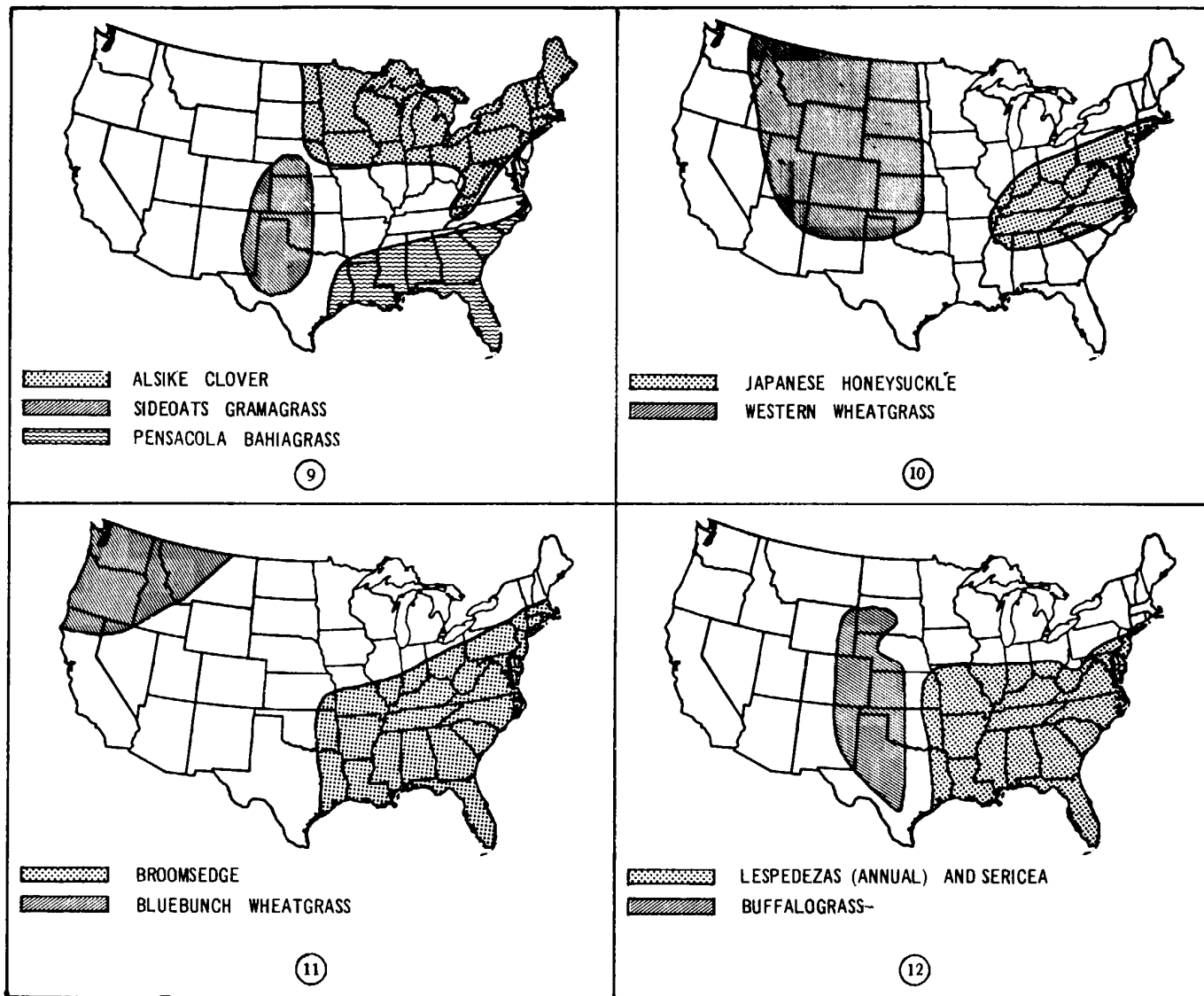

Figure 15-1. Continued

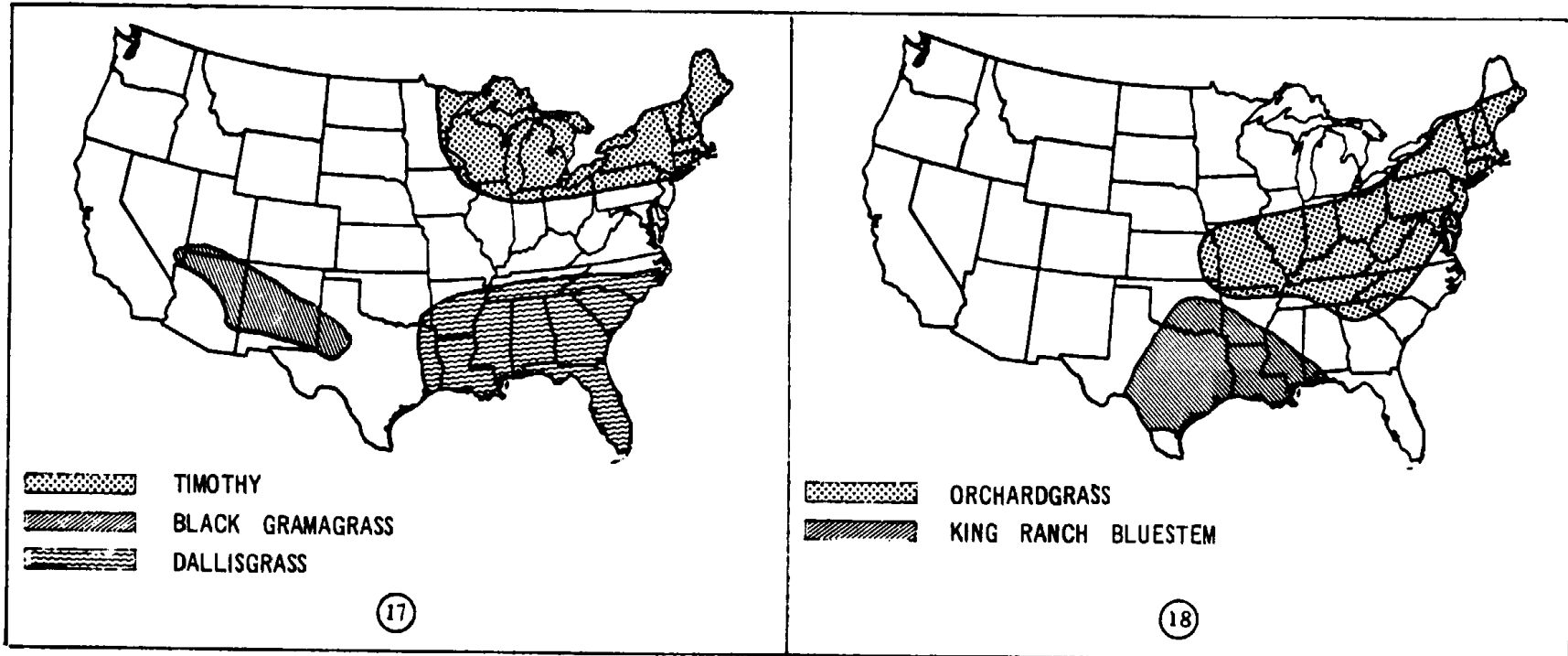

Figure 15-1. Continued

15-5.10. Tilling, Grading, and Drainage. Tilling and grading are important procedures in preventing erosion and preparing soil for the establishment of turf. Following construction, soil and subsoil materials are often in poor condition for planting. Remove debris remaining after construction operations. Break up any stone or gravel layers with a ripper or a subsoiler, then use a tractor-operated disk plow or a chisel-type tillage tool to mix and pulverize the upper 5 to 10 inches of soil. The rotary tiller is also helpful, but may be effective only to a depth of 2 or 3 inches. If practicable, irrigate soil that is too dry to permit tillage. Irrigation or rains should follow a tillage operation to permit settling of the soil before the seeding of improved lawns. Check grade elevations (by instruments where necessary) not only before seedbed preparation but also after seedbed preparation to assure that:

15-5.10.1. Runoff from rains does not accumulate on the planted area or against structures.

15-5.10.2. Prominent ridges, depressions, and unnecessarily steep grades are eliminated to insure economical maintenance of the planted area.

15-5.10.3. Sidewalks and other pavement edges are properly matched to adjacent soil surfaces to reduce the amount of trimming and edging required. Wherever possible, elevation of finished seedbed drainage. Pulverize and smooth the soil base prior to should be 1 inch below the elevation of pavement edges.

15-5.10.4. Imported or stockpiled topsoil is available for areas containing sand, rock, gravel, harmful salts or other material that cannot support normal plant growth. Unweathered topsoils normally support grasses satisfactorily if improved with fertilizers. Soils containing root remains and other indications of weathering are desirable for seedbeds but not essential. Make soil analyses of topsoil to be used (para. 5-4). Do not use topsoils of unspecified texture. (See chap. 8 for topsoil and soil mixes.) Make sure that materials used do not contain objectionable salts or noxious weeds (wild onion, dallis grass, nut grass, nimble Will, crab grass seed), or consist of materials inferior to the existing surface soils.

15-5.11. Seedbed Preparation.

15-5.11.1. Normal soils or subsoils. Where rock, gravel, or other obstructions do not interfere, till to a depth of 5 inches. Mix in fertilizers and limestone as prescribed in the applicable paragraphs that follow. Remove stones, tree roots, building refuse, or other materials that may interfere with seedbed preparation or future maintenance. Apply fertilizers and ground limestone, then allow rain or irrigation to overcome possible effects of limestone in depressing plant growth and to locate minor surface irregularities in the seedbed. At planting

time recheck grade elevations and follow with light harrowing, raking, and minor leveling, as necessary.

15-5.11.2. Abnormal soils or subsoils. Where rock, gravel, or other obstructions prevent tillage apply 4 to 6 inches of soil (para 15-5.10.4). Use clay loam where available; avoid sand and sandy loam except as described in paragraph 15-5.11.3. Smooth ail areas on which soil is to be spread to permit uniform final grading and soil application. Before spreading soil, loosen and roughen surfaces packed by construction equipment to eliminate obstructions to root penetration and to assure proper bonding of the soil materials. Improve deep sands by applying clay or silt loam as a surface cover or by mixing muck or other available materials into the sandy surfaces.

15-5.11.3. Recreational areas. Superior grade turf used for football playing fields, baseball infields, and similar intensive uses may require special soil mixes to provide conditions favorable to plant growth. Where such improvements are necessary, mix peat or other organic material into a sandy loam off the site and spread it uniformly over the area to a depth of 3 inches. Grade as necessary to assure drainage. Pulverize and smooth the soil base prior to spreading soil mix. As much as 8 inches of soils with exceptionally poor interior drainage.(clays and soils high in silt or fine sand content) may need to be removed and replaced with a mixture of sandy clay loam and organic soil. Mix reedsedge or sphagnum peat at a rate of 50 pounds (oven-dry basis) to each cubic yard of soil. Apply fertilizer, limestone, or both, and mix into the surface soil to the depth of 3 inches. Spread the mix long enough before seeding to permit rains or irrigation to display minor surface irregularities.

15-5.12. Fertilizing.

15-5.12.1. Initial fertilizing. Initial fertilizing should be based on complete laboratory tests of soil samples taken from the site to be planted, or, where available, on plot tests of established turf on nearby sites, or on both. Prior to seeding, improve the soil by mixing the following fertilizers into the freshly tilled seedbed at the rates indicated on a 1,000 square foot basis:

15-5.12.1.1. For soils deficient in phosphate and potash use 35 pounds of 5-10-5 commercial fertilizer or similar material. Substitute 5-10-10 for sandy soils, especially in the eastern humid zones.

15-5.12.1.2. For soils deficient in phosphate but not in potash use 6 pounds of ammonium nitrate and 12 pounds of super-phosphate or their nitrogen and phosphate equivalents. Substitute 10 pounds of ammonium sulfate for ammonium nitrate where iron deficiencies result in chlorosis of established turf in the area (evidenced by mottled light and dark leaf color).

15-5.12.1.8. For soils with adequate phosphate and potash, use 6 pounds of ammonium nitrate or its nitrogen equivalent. Substitute 10 pounds of ammonium sulfate where iron deficiencies result in chlorosis.

15-5.12.1.4. For soils with a pH of 5.5 or lower, use 50 pounds of agricultural ground limestone. (Coordinate with para. 8-3.)

15-5.12.2. *Followup fertilizing.* After seeding or planting, use the following kinds of fertilizer and rates of application on a 1,000 square-foot basis:

15-5.12.2.1. Immediately after planting, use 6 pounds of ammonium nitrate or its nitrogen equivalent.

15-5.12.2.2. From 40 to 60 days after seeding or planting, apply 6 pounds of ammonium nitrate or its nitrogen equivalent.

15-5.12.2.3. One year after planting warm-season grasses and in the following September for cool-season grasses, make soil tests (para. 5-4) and apply 20 pounds of 10-6-4 or similar grade of fertilizer to soils deficient in phosphate and potash. To soils deficient in phosphate but not in potash, apply 6 pounds of ammonium nitrate and 12 pounds of superphosphate or their equivalents. To soils where iron deficiencies are persistent, use 12 pounds of iron sulfate per 1,000 square feet, or spray the area as often as the deficiency appears with a solution of 2 ounces of iron sulfate in 5 gallons of water (11 grams per gallon). Coordinate fertilizing recommendations with those in chapter 8.

15-5.13. *Seed.*

15-5.13.1. *Seed quality.* Grass seed, as sold commercially, normally contains many impurities. When analyzed, a seed sample is reported as having a certain percent purity, which means that a specified weight of the sample (e.g., 100 grams) has a certain percentage by weight of grains or kernels. In many kinds of grass these seed grains may be inclosed in a chaffy husk. Chaffy husks without grains, weed seed, and other material not of the desired kind of seed are weighed and classified as impurities. The weed seed component is weighed and computed separately. A specified number of the seed from the lot weighed and computed as pure seed (e.g., 100 seed) are placed in a germinating chamber, where conditions of moisture and temperature

are favorable for germination. At intervals, the seed that germinate are removed and recorded. Seed that do not germinate and do not decompose are called "hard seed." Percent germination and percent hard seed are determined from these seed counts after a specified period of test for the seed kind. Hard seed may be of good quality, but germination is delayed because of dormancy or impermeable seed coat. There are some advantages to having some hard seed in the mixture, especially when plantings are made under dryland conditions. Noxious weed seed are counted and recorded in number per ounce or pound. These data are normally included on the label of the seed container.

15-6.13.2. *Federal standards.* Federal seed laws require that the containers of seed offered in interstate trade exhibit the percent germination, percent purity, percent weed seeds, and name of each seed kind by percent for species in excess of 5 percent. In addition, the label will normally show each weed seed that is considered noxious by the State in which the test is made. Canada thistle, field bind-weed, dodder, buckhorn, wild onion, quackgrass, and Johnson grass are common examples. The date of test and percent hard seed shall be shown on the label, and where applicable the source of seed. Specifications will meet the requirements of Federal Specification JJJ-S-181 and will state in the contract minimum percentages of germination and purity, maximum percentages of hard seed and weed seed, and the kinds of seed. For most grass seeds, percent germination and percent hard seed may be combined into one requirement for purchase or planting contracts. Weed seed will not exceed 1 percent of the total.

15-5.13.3. *Sampling and testing.* Where question arises as to accuracy of tests, or where date of test on the label indicates a new test to be necessary, obtain a composite sample from the seed furnished and send it to the appropriate State or commercial seed laboratory. Such tests provide a sound basis for claim by the Government if it is determined that the seed did not meet the specification. It is advisable to have samples drawn by a representative of a reputable seed testing laboratory or by a Department of Agriculture representative, where practicable. Seed that has not been tested for 12 months prior to the planting date will be retested.

15-5.13.4. *Pure live seed.* Guide specification CE-808

provides for seed procurement on the basis of pure live seed. This factor is derived by multiplying percent purity by percent germination. The use of pure live seed as a basis for procurement permits the vendor to use available seed supplies having variable purity and germination which result from seasonal conditions beyond his control. Greater flexibility is permitted the vendor without reducing the quality of the final product, which encourages more and lower bids. It also helps avoid delays due to inadequate stocks of one or more of the seed kinds of rigidly prescribed standards. Percent pure live seed for most seed kinds of interest to military installations is shown in table 15-1. For other kinds, use data from available manuals, textbooks, and specifications (e.g., Federal Specification JJJ-S-181). For single, unmixed species the data in table 15-1 are normally adequate without further computation. For mixtures with two or more seed kinds, compute as shown in the following example for a 50-50 mixture of Kentucky bluegrass and chewings fescue:

<i>Seed kind</i>	<i>Percent kind by weight in mixture</i>	<i>Percent pure live seed of each kind</i>	<i>Percent pure live seed in mixture</i>
(1)	(2)	(3)	(4)
Kentucky bluegrass	50	68	34
Chewings fescue	50	78	39
Total pure live seed in mixture, percent.....			73
Other than pure live seed, percent			27
			100

Note. Obtain data for column 3 from table 15-1. Compute column 4 by multiplying column 2 by column 3.

For more complete detail in computing seed mixtures, see Federal Specification JJJ-S-181.

15-5.13.5. Seeding.

15-5.13.5.1. Seeding rates. Table 15-1 provides a general guide for planting single kinds of the principal grasses and cereal grains. Somewhat lower rates may be used under ideal seedbed conditions or where rapid vegetative coverage is not necessary. When more than one seed kind is planted on the site, reduce the amount of each kind proportionately. For example, for Kentucky bluegrass and chewings fescue with planting rates of 2.5 pounds and 3.0 pounds per 1,000 square feet on lawns, respectively, plant 1.25 pounds of the former and 1.50

pounds of the latter, or 2.75 pounds for a 50-50 mixture. Compute to the nearest quarter of a pound for 1,000 square feet and the nearest pound for acre rates.

Seed is normally purchased unmixed and is mixed prior to planting.

15-5.13.5.2. Selection of mixtures. Avoid complex mixtures of many kinds. For a single site there is normally only one or two species which can be expected to persist in a mature, long-lasting turf (5 years of age or more). Species which do not contribute to a long-lasting turf should not be planted except as a companion crop (e.g., rye grass) to provide a quick cover for erosion control. Use light rates of temporary species to prevent competition and smothering of the permanent plants.

15-5.14. Seasons for Planting. The various climatic zones have definite seasons that are most favorable for the establishment of permanent vegetation (fig. 15-2).

15-5.14.1. Planting zones 1 and 3. Both fall and spring plantings are used. Late August to early September is the most favorable fall period; April is the most favorable spring period. Plant Sudan grass and sorghums for cover crops in May or June.

15-5.14.2. Planting zone 2.

15-5.14.2.1. East of the 98th meridian or westward where irrigation is used, plant Kentucky bluegrass, fescues, smooth brome grass, and crested wheat grass in September or April to May (depending on latitude).

15-5.14.2.2. Under dryland conditions, west of the 98th meridian, plant in the spring for all perennial species, preferably in March in southern parts of the zone to early May in the northern parts.

15-5.14.2.3. Plant Sudan grass and sorghums for cover crops in May or June and wheat or rye in September.

15-5.14.3. Planting zones 4 and 6.

15-5.14.3.1. Plant seed of Bermuda grass, King Ranch bluestem, tail fescue (Kentucky 31 and Alta), and lespedeza in April.

15-5.14.3.2. Plant spriggs or plugs of Bermuda grass or Zoysia in April through June.

15-5.14.3.3. Plant dryland species such as buffalo and blue grama grasses in late March or April.

15-5.14.3.4. Plant Kentucky bluegrass in September.

15-5.14.3.5. Plant cover crops such as Sudan grass and sorghums in May or June; and rye grass, oats, barley, wheat, and rye in September. Rye grass and oats may be planted in March through May where emergency plantings for erosion control are required.

15-5.14.4. Planting zone 5.

15-5.14.4.1. Plant seed of Bermuda, bahia, and centipede grasses in March through May.

15-5.14.4.2. Plant spriggs or plugs of Bermuda Zoysia, centipede, and St. Augustine in March through June.

15-5.14.4.3. Plant tall fescue (Kentucky 31 or Alta) in September or October.

15-5.14.4.4. Plant cover crops such as oats, rye, rye grass, barley, or wheat in October and November, and Sudan grass or sorghums in April through June.

15-5.14.5. Planting zone 7.

15-5.14.5.1. Plant Bermuda, kikuyu, ice plant, and St. Augustine in February through June. Where irrigation is not used, for ice plant for example, plant in December through March

15-5.14.5.2. Plant native brome grasses, Kentucky bluegrass, and tall fescue (Kentucky 31 or Alta) in October or November.

15-5.14.5.3. Plant cover crops such as Sudan grass or sorghums in March or April; and wheat, rye, rye grass, barley, and oats in September through November. Rye grass may also be planted in February through May as an emergency soil cover.

15-5.14.6. Planting zones, Caribbean and Hawaii Planting seasons are not well marked. Where the seedbed cannot be irrigated adjust planting period to dry and wet rainfall months.

15-5.14.7. Planting zone, Alaska Plant all perennial grasses in May or June, and cover crop grasses in July and August.

15-5.15 Planting Methods.

Note: For seeding and sprigging utilizing hydro-mulching see appendix J, Hydro-Mulching.

15-5.15.1. Seeding. Plant seed by use of special grass drills or grain drill attachments, by broadcasting over the area, or by spreading mulch containing viable seed. Uniform distribution is important. Cover the perennial grass seed to the extent practicable to a depth of 1/4 to 1/2 inch Cereal grains and similar large-seeded species should be covered to a depth of 1 to 2 inches depending on the soil type. Where seed is broadcast by hand or scattered on the soil surface with seed drills, follow the operation with light harrowing or raking to cover the seed. Inoculate all legume seed to be planted unless it is certain that sufficient nodule bacteria are present in the soil. The proper strain of bacteria must be present if nitrogen fixation is to take place. (Nitrogen fixation is the process by which nodule bacteria take nitrogen from the

air and change it into a form that can be used by plants.) Groups of legumes inoculated by different strains of bacteria are:

Alfalfa and sweet clover

Red, mammoth, alsike and white clover

Lespedeza

Soybeans

Crown vetch

Secure specific inoculant when seed is purchased and use it before the expiration date. Seed should be inoculated just before planting and as directed by the label on each container.

15-5.15.2. Sprigging.

15-5.15.2.1. Planting of Bermuda grass is normally by sprigs. Common Bermuda grass is generally established by seeding. The use of sprigs permits planting over a longer period of time, and assures survival through the first winter. The improved strains of Bermuda grass are available only as vegetative material.

15-5.15.2.2. Keep sprigs moist at all times and protect them from molding or heating in the piles. For best results, plant sprigs immediately after digging. Sprigs that are transported from harvest site to planting site, must be kept moist and protected from the sun and drying wind. Where sprigs must be shipped from distant points, be sure to coordinate plant shipments with the planting schedule to permit planting immediately upon receipt of shipment.

15-5.15.2.3. Where possible, plant sprigs in shallow furrows and cover with soil at once. Planting machines may be used on larger areas. Spacing of the rows is normally 18 inches and sprig clusters should be 12 inches apart in the rows. On unimproved grounds and airfields, Bermuda grass may be planted at greater distances. Space slow-spreading species such as centipede and Zoysia not greater than 18 inches between the rows. Spot sprigging may be necessary on embankments and slopes; this is accomplished by opening a slit with a spade and inserting the sprigs into the opening, then closing it by pressing with the foot. In planting zone 5, and North Carolina and Virginia in zone 4, leave part of each sprig cluster exposed to the air.

15-5.15.3 Firming and correcting grade. Use a cultivator-packer to smooth and firm seeded or sprigged areas prior to mulching. On lawns and recreational areas, assure that planting operations

have not created irregularities in the grade. Where irregularities in the grade occur, fill low spots and reseed where necessary.

15-5.16. Mulching. (Coordinate this subject with app. J, Hydro-Mulching.)

Note: Some of the mulch material and methods within this paragraph apply to landscape plantings.

Particular local conditions establish the need for a seedbed mulch. When in doubt, apply mulch. Mulching provides the following benefits: conserves moisture and prevents sharp temperature fluctuations in the soil, improves soil structure and aeration, prevents wind and water erosion, controls or reduces weed growth, and decreases maintenance costs. Mulches should be resistant to fire, attractive, and relatively inexpensive.

15-5.16.1. Classification Mulches may be classified as organic or inorganic.

15-5.16.1.1. Organic. Organic mulches are usually debris or byproducts of plants. Occasionally, animal manures may be used. The organic matter decomposes on the surface, and the decomposition products (i.e., humus and other compounds) slowly work down through the soil aggregates. A soil structure with greater porosity, which in turn develops into greater air- and water-holding capacity, results. Therefore, organic mulches are of definite benefit to the soil. Many of the more commonly used organic mulches are described in table 7-1.

15-5.16.1.2. Inorganic. Inorganic mulches are natural or manmade substances which provide long-term protection. Some commonly used inorganic mulches are described in table 7-2.

15-5.16.2. Selection. No one mulch is ideal for all situations. In prominent places where appearance is foremost and space limited, chunk bark, crushed rock, or arcillite may be used; in less conspicuous locations where stability is most important, wood chips, sawdust, or polyethylene plastic may be less expensive, while fully as efficient. Transportation is an important item determining the relative cost of a mulch. A more expensive mulch from a nearby source may cost less than a cheaper material located further away. Other factors to consider when selecting a mulch are its relative value for weed control, availability, ease of application, and fire hazard.

15-5.16.3. Application

15-5.16.3.1. Organic.

15-5.16.3.1.1. Time. The appropriate time to apply a mulch depends upon the objective of its use. The soil temperature beneath a mulch lags considerably behind the air temperature. In the spring, mulched soil is slow to

warm up, while in the fall it will stay warm until early winter. The primary objective of a winter mulch is to maintain a relatively constant soil temperature, thus preventing freezing and thawing. Therefore, a mulch applied just after the ground has frozen in early winter would be most beneficial. The objectives of a summer mulch are to conserve moisture, keep the root zone cool and prevent weed growth. Summer mulches should be applied in the spring before the onset of hot weather.

15-5.16.3.1.2. Depth. The appropriate depth of mulch necessarily varies with the material. As a rule, the greater the depth of any mulch, the fewer weeds that will appear. Recommended depths for various mulches are indicated in tables 7-1 and 7-2.

15-5.16.3.2. Inorganic. Bulk materials such as crushed stone, gravel and arcillite ordinarily are applied in excavated areas 2 to 3 inches deep. A sheet of polyethylene should be spread on the surface of the exposed soil; then the mulch should be spread on the sheet until it reaches the level of the original soil.

15-5.16.4. Disadvantages. The use of organic mulches may result in the following disadvantages:

15-5.16.4.1. Nitrogen deficiency. Bacteria and other soil micro-organisms break down the carbohydrates in organic matter, but in order to thrive, they must use nitrogen to form proteins and other compounds. These micro-organisms soon deplete the soil solution of nitrates. Plants growing in such a situation will suffer nitrogen starvation. Therefore, enough nitrogen must be added to mulch to satisfy the needs of the micro-organisms as well as the plants. It is recommended that 1.5 to 2 percent of elemental nitrogen (N) be added on the basis of the dry weight of the organic matter. Following is an illustration of this requirement:

One ton of sawdust contains approximately 50 percent water and 50 percent dry matter. On the basis of 2 percent, 20 pounds of N would be needed. Ammonium sulphate contains 20 percent N. Therefore, 100 pounds of ammonium sulphate would be required. The nitrogen fertilizer may be spread on the surface of the mulch if it is anticipated that rain or irrigation will soon follow to disperse the fertilizer throughout the mulch.

15-5.16.4.2. Frost damage. Mineral soil warms up much faster in the spring than mulches do. On cold nights, the warm soil will reradiate heat to the plants above. Therefore, some mulches may cause damage to ornamental plants which bloom or leaf out early in the

out early in the spring (before the frost-free period). However, the many advantages of mulch may outweigh the frost damage potential. The vegetative and flowering pattern of the plants should be considered in selecting a mulch. For example, an airy, loose mulch, such as evergreen boughs, may protect plants from winter winds and, yet, can be easily removed in the early spring to permit the soil to warm up.

15-5.16.4.3. Rodents. Most organic and some inorganic (e.g., polyethylene) mulches furnish a protected haven for mice during the winter. It is advisable to utilize an acceptable control measure for mice in the late fall or early winter where mulches are used.

15-5.16.4.4. Pests. Both harmful insects and the spores of fungus diseases may reside in mulches during the winter and other seasons. Spraying with insecticides and fungicides and periodically removing and renewing the mulch will help.

15-5.16.4.5. Weeds. The seeds of noxious weeds may be transported in many organic mulches, particularly hay, straw, and animal manures.

15-5.16.5. Storage. Storage can present a problem since organic mulches may decompose before their application. More expensive mulches should preferably be stored in a well ventilated area protected from the weather.

15-5.17. Sodding. Repair of previously planted areas may at times be performed by use of strips or squares of sod. Planting of steep slopes and channels may require sod rather than seed or sprigs. Do not use sodding unnecessarily since costs are relatively high. The following criteria will be observed:

15-5.17.1. Prepare the soil area to be sodded, generally, in the same manner as if the area was to be seeded. (See paras. 15-5.10. through 15-5.12.)

15-5.17.2. Wherever possible, obtain sod from a member of the appropriate State turf grass (sod) growers association. Many, if not all, of these organizations have guide specifications for sodding. The American Sod Producers Association, Inc., (app D, no. 7) does have guideline specifications for sodding. It is recommended that the installation land manager obtain a copy of these specifications.

15-5.17.3. Water sod until turf is well rooted.

15-5.18. Irrigation of New Turf. The establishment of good turf is often dependent upon a continuous supply of moisture at planting time. Irrigation is especially important for improved lawns, parade grounds, and recreational areas. Under conditions of low rainfall during the planting period, water should be provided for all sites

where a durable, long-lasting turf is required. (See chap. 16, Irrigation) Lawns, recreational areas, parade grounds, and the like which are to be irrigated recurrently after establishment should have an adequate and continuous water supply available prior to planting. For turf in low rainfall areas (less than 30 inches annually), especially on recreational areas, an underground irrigation system is necessary. Thoroughly moisten the seedbed, after seeding or sprigging, to a depth of 3 inches or more. After the initial irrigation, light, frequent sprinkling is better than heavy application. For small areas, hand watering is preferred, but be sure the stream is not directed against the seedbed. Set the nozzle to deliver a spray with large droplets and play the spray over the planted area. For large areas, use a slow-rotating sprinkler head, but operate the system at one position not more than 30 minutes to prevent puddling and runoff. Daily application may be necessary during periods of high temperature. For best results, all newly seeded areas receiving irrigation should be mulched. Watering unmulched areas may destroy the prepared seedbed. Continue irrigation as needed until the turf is well rooted, normally 30 to 60 days.

15-5.19. Preliminary Maintenance.

15-5.19.1. Mowing. For lawn and recreational areas mow turf after planting as soon as growth averages 3 inches high. For less intensively used areas allow 4 inches height before mowing. Continue to mow planted areas regularly until a firm turf is established, usually about 60 to 90 days. Use mowers with sharp blades to avoid pulling out young seedlings. Do not neglect mowing planted areas; to do so permits weedy growths to choke out permanent grasses and encourages seedling diseases.

15-5.19.2. Improving the grade. On improved grounds and recreational areas, provide close inspection for low spots or poor drainage. Repair where necessary by filling, shaping, and replanting. Correct minor irregularities by use of top-dressing with friable soil. Do not use sand for top-dressing, unless the original seedbed was of this material.

15-5.19.3. Repair. Inspect all areas for planting failures. Areas where loss of soil or seed from erosion has occurred will be repaired promptly, seeded, and mulched to take advantage of the proper planting season. Replace mulch that may have blown off. Fertilize areas that have been missed in the original treatments.

15-5.19.4. *Fertilizing.* Under some conditions, fertilizer rates used in making the planting have not been adequate to keep plant growth active during the establishment period. Where such conditions arise, as determined by the appearance of the turf, make a supplemental application, normally at a rate of 2 pounds of nitrogen per 1,000 square feet (e.g., 6 pounds of ammonium nitrate). Stunted growth and a yellowish leaf

color are indications that nitrogen is required, especially when irrigation and rainfall have been adequate for moisture supply. Subsequent fertilizer treatments should be as prescribed in chapter 8 and based on results of soil tests. Where soil tests indicate the pH should be increased, apply additional amounts of ground limestone, normally in increments of 50 pounds per 100 square feet, until correction has been attained.

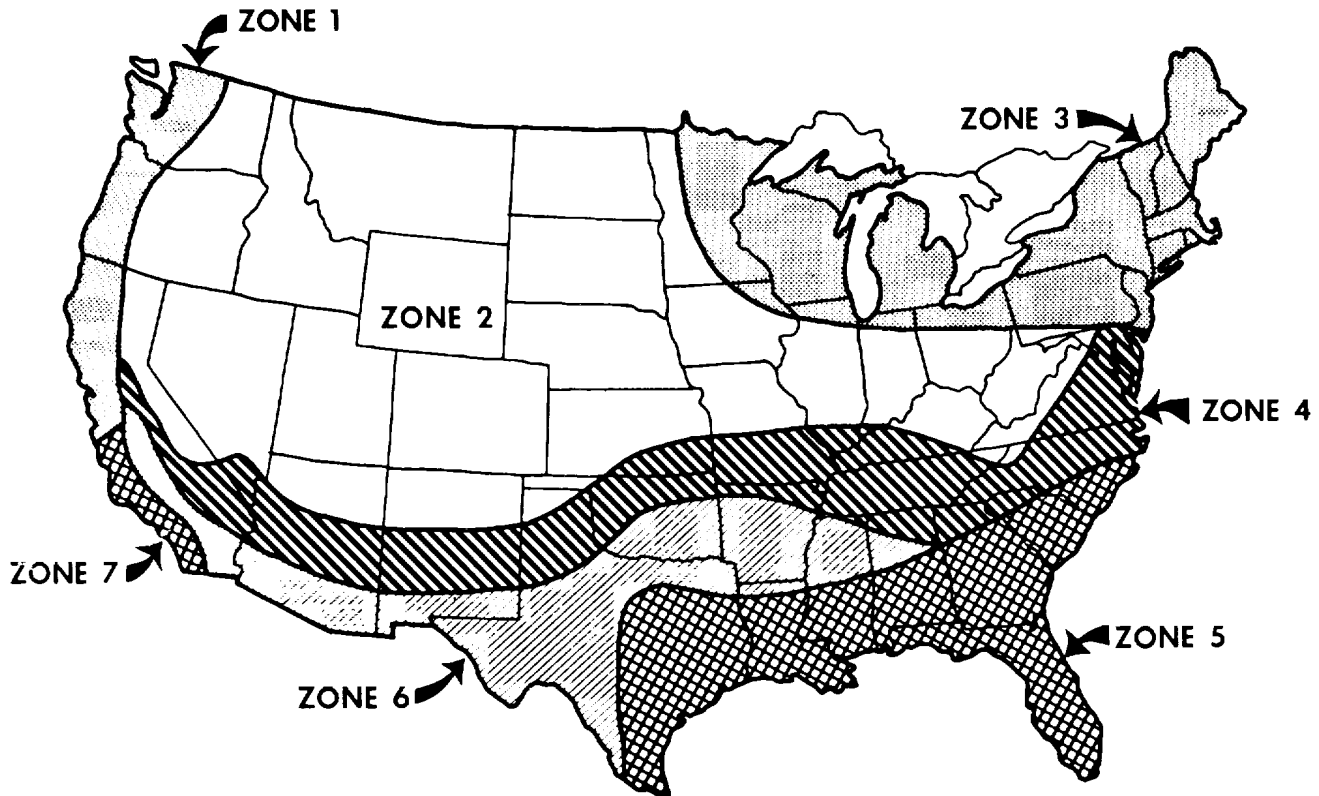

Figure 15-2 Planting zones for grasses.

15-6. Trees, Shrubs, Ground Covers, and Vines.

(The Landscape Planting and Maintenance Plan (see TM 5-803-5/AFM 88-17/NAVFAC P-960, Installation Design, chap. 1, Planting Design).

15-6.1. Purpose of the Planting Plan.

A landscape planting and maintenance plan for military installations provides a workable, longrange guide to assure establishment of a pleasant environment conducive to the health, welfare, and morale of personnel. The plan illustrates the arrangement of plant materials on the site and describes planting and maintenance methods. Follow the outline provided in annex I to appendix C.

15-6.2. Design Considerations.

The development of a landscape planting plan suitable to

the functions and character of a particular installation requires the professional training and skill of a competent landscape architect. If a trained and experienced person is not available at installation level, obtain the services of a specialist to prepare a complete plan. In the planting design, the objective is to-

15-6.2.1. Blend the buildings with the general landscape to obtain a harmonious effect.

15-6.2.2. Provide shade.

15-6.2.3. Screen unsightly parts of the installation.

15-6.2.4. Create windbreaks at strategic locations. Consider direction of prevailing winds, including desirable summer breezes; position of the structures or areas to be protected; and accumulation of snow

on roads and railroads. Evergreens furnish protection throughout the year and are usually more suitable than deciduous species.

15-6.2.5. Control erosion and dust.

15-6.2.6. Avoid plantings that will constitute traffic hazards, such as tall shrub groups at street corners and intersections.

15-6.2.7. Space trees, shrubs, and other ornamentals so they will not be overcrowded as they develop normally (table 15-2).

15-6.2.8. Place trees so they will not grow into electric and telephone lines, interfere with underground utilities, or prevent vistas from windows and doors.

15-6.2.9. Select only those trees, shrubs, vines, and other ornamentals that are known to be well adapted to the soil and climate of the region, and resistant to prevalent insects, diseases, and other pests.

15-6.2.10. Eliminate ail plant materials that require excessive and continuous maintenance. Closely clipped hedges are an illustration of undesirable plantings, because of the high labor requirements.

15-6.2.11. Emphasize the grounds adjoining principal structures at the installation, such as the installation headquarters, station hospital, and the main entrance to enhance the particular facility and not obstruct the view.

15-6.2.12. Limit foundation plantings of trees and shrubs to a minimum (generally not to cover more than one-fourth of the building foundation perimeter).

15-6.2.13. Eliminate vines wherever they may damage foundations, roofs, windows, or power and telephone lines, and where they may provide an entrance for termites or ants.

15-6.2.14. Avoid spacing shrubs or trees singly or in small groups which prevent use of tractor-operated mowers.

15-6.2.15. Restrict flower beds to hospital, cemetery, and club areas, main installation entrances, and the rear of residences, so that beds will not obstruct power mowing

equipment and raise maintenance costs.

15-6.2.16. Develop a practical maintenance program within the limitations of personnel, equipment, and materials available.

15-6.2.17. Use low shrub planting or vegetative screens to aid in directing foot traffic to established walks. This is more desirable than unsightly signs or other barriers which increase maintenance cost.

15-6.2.18 Use simple, informal planting arrangements that create an orderly appearance. Make extensive use of open lawn areas since such areas are pleasing to the eye, adaptable to many uses, and are relatively inexpensive to establish and maintain.

15-6.2.19. Use a planting plan which is compatible with the master plan for future development of the installation.

15-6.2.20. Limit the acceptance of planting materials available locally as gifts from nurseries, other military installations, and from private donors to those which conform to the planting plan.

15-6.2.21. Preserve and maintain sweeping curves of native vegetation and general pattern of terrain.

15-6.2.22. Locate shrub groups, roadside signs, and other markers so that they do not seriously interfere with mowing operations.

15-6.2.23. Design broad, easily mowed drainage channels with slopes no steeper than 3 to 1, where conditions permit.

15-6.2.24. The planting of street trees is one of the most effective uses of plant materials on military installations to visually reinforce the hierarchy of the vehicular road network and land use areas, provide shade, and improve the overall visual quality of the installation "street scape." A systematic design approach should be employed to establish a coordinated street tree planting plan.

Table 15-2. Spacing of trees and shrubs

<i>Mature height</i>	<i>Minimum distance from each other (in feet)</i>	<i>Minimum distance from a structure (in feet)</i>
Large shade trees (30 ft and taller)	35	20
Smaller trees, including broad crowned conifers.....	20	10
Shrubs over 12 ft and narrow crowned conifers.....	10	6
Shrubs, 6 to 12 ft.....	8	4
Shrubs, 2 to 6 ft.....	4	3
Shrubs, less than 2 ft.....	2	2

15-6.3. *Selection of Plants.* In addition to soil and climatic response the plants selected for planting should be weighed against other considerations:

- Need for rapid coverage or development.
- Site preparation and planting costs.
- Winter injury-ice storm and limb breakage.
- Retention of lower limbs.
- Tolerance to shade, salt spray, city fumes.
- Production of trash from twig, leaf, bark and fruit shedding.
- Retention of form with minimum pruning.
- Barrier species to deter trespassing.
- Low flammability index
- Tile clogging from roots.

15-6.4. *Planting Zones (Woody).* Since this manual can give only general guidelines on the usefulness of any specific species to broad geographic areas, check the plants listed in the tables against known local

performance. Add local lists of reliable plants to those indicated in the tables. Figure 15-3 shows planting zones within the United States. Zones in the Caribbean, Alaska, and Hawaii are not illustrated. The zones are based on climatic and soil conditions, including alkalinity and acidity of soils, humidity, need for irrigation, and summer and winter temperatures.

15-6.4.1. Zone 1 (Pacific Northwest) has acid soils and a relatively humid climate with most of the rain-fall during the winter months. Temperatures are not usually extremely high or low.

15-6.4.2. Zone 2 (Plains and Intermountains) has relatively alkaline soils and is dry and unfavorable for landscape trees and shrubs except when irrigated or where water accumulates as subirrigation or in drainageways. Extreme high and low temperatures are encountered.

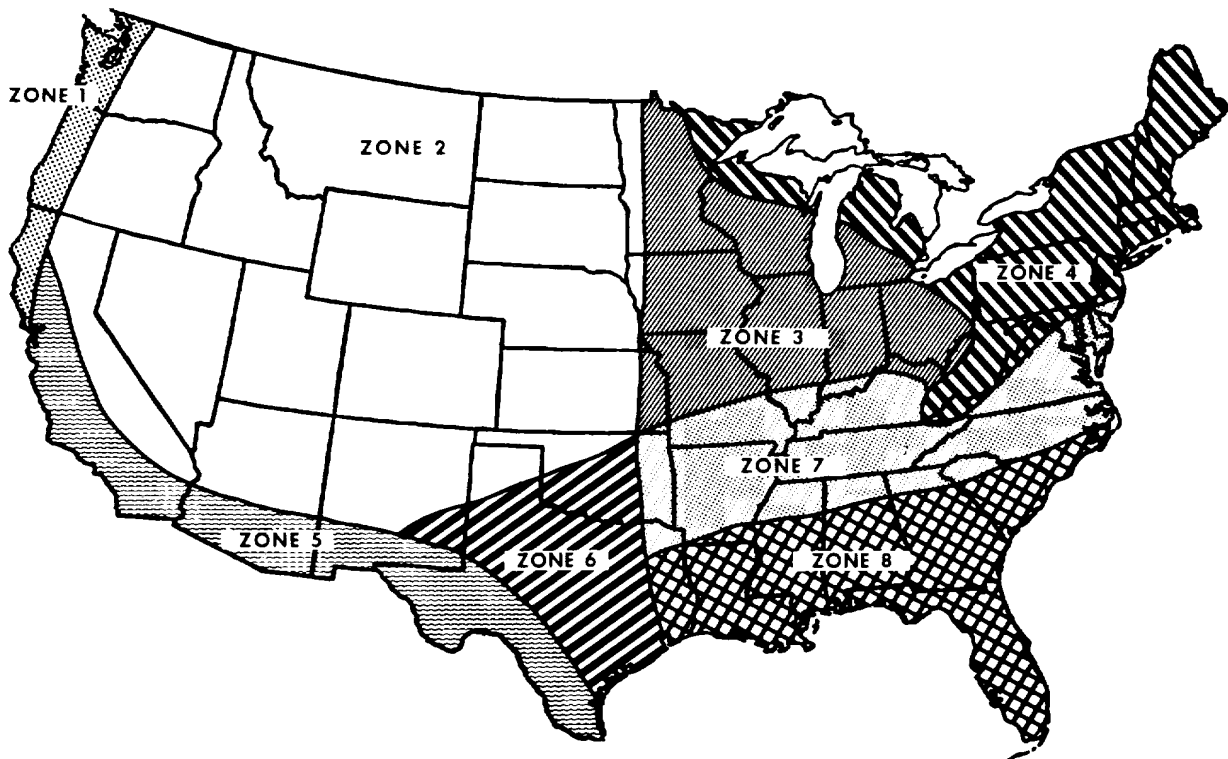

Figure 15-3. Zone for windbreak and landscape plantings.

15-0.4.3. Zone 3 (Midwest) has soils neither very acid nor very alkaline. There is adequate rainfall to support trees and shrubs without irrigation, except during infrequent severe droughts and in aid sites. High summer and low winter temperatures are typical.

15-6.4.4. Zone 4 (Northwest) has relatively acid soils. Rainfall is usually adequate throughout the year, and irrigation is not usually required. Winter temperatures are low.

15-6.4.5. Zone 5 (Southwest) has alkaline soils (extremely alkaline in some places) and is arid and unfavorable for most woody plants unless irrigated. High

summer temperatures are prevalent for most of the zone; winter temperatures are moderate and permit the use of species not adapted farther north.

15-6.4.6. Zone 6 (Central Southwest) has alkaline soils and little rainfall. Irrigation is usually required, specially in the western parts of the zone. Drought-resistant species with moderate resistance to low winter temperatures are required. Late spring freezes may damage plants. Summer temperatures are high.

15-6.4.7. Zone 7 (Midsouth) has soils neither very acid nor very alkaline. Year-around rainfall is usually adequate for plant growth without irrigation. Winter and summer temperatures are moderate.

15-6.4.8. Zone 8 (Southeast) has neutral to acid soils and adequate rainfall for plant growth without irrigation. Temperatures are moderate, permitting the use of material not hardy northward.

15-6.5. *Plant Lists (Trees and Shrubs)*. The following plant lists indicate typical trees and shrubs suitable for use at military installations within each zone. Other species may be added to this list on the advice of plant material specialists and on the basis of experience in local plantings in parks and lawns. The symbol W indicates species especially useful for windbreaks.

15-5.1. *Zone 1 (Pacific Northwest)*.

Shade and windbreak trees.

Sugar Maple (*Acer saccharum*)
Black Walnut (*Juglans nigra*)
Scarlet Oak (*Quercus coccinea*)
Oriental Plane (*Platanus orientalis*)
Decaisne Black Locust (*Robinia Pseudoacacia* var. *Decaisne*)
Northern Red Oak (*Quercus borealis*)
Western Hemlock (*Tsuga heterophylla* W)
Douglas Fir (*Pseudotsuga taxifolia* W)
Ponderosa Pine (*Pinus ponderosa* W)
Incense Cedar (*Libocedrus decurrens*)
Western Red Cedar (*Thuja plicata* W)

Ornamental trees.

Japanese Maple (*Acer palmatum*)
Shirotae. Oriental Cherry (*Prunus serrulata* var. *Shirotae*)
Carmine Crabapple (*Malus astrosanquinea* var. *Carmine*)
White Birch (*Betula papyrifera*)
American Holly (*Ilex opaca*)
Flowering Dogwood (*Cornus florida*)
Saucer Magnolia (*Magnolia soulangeana*)
Lavalle Hawthorn (*Crataegus lavallei*)
Fragrant Snowbell (*Styrax obassia*)
Blireiana Plum (*Prunus blireiana*)

Shrubs.

Warty Barberry (*Berberis uerruculosa*)
David Viburnum (*Viburnum davidi*)
Glossy Abelia (*Abelia grandiflora*)
Appleblossom Escallonia (*Escallonia viscosa*)
Salal (*Gaultheria shallon*)
Peking Cotoneaster (*Cotoneaster acutifolia*)
Azalea or Rhododendron (*Azalea* or *Rhododendron* spp)
Siberia Pea (*Caragana arborescens* W)
Japanese Barberry (*Berberis thunbergi*)
Chinese Holly (*Ilex cornuta*)
Oregon Grape (*Mahonia aquifolium*)

15-6.5.2. *Zone 2 (Plains and Intermountains)*.

Shade and windbreak trees.

Chinese Elm (*Ulmus pumila*)
(Dropmore variety in northern part of zone)
Common Hackberry (*Celtis occidentalis* W)
Cottonwood (*Populus* spp) W
Green Ash (*Fraxinus lanceolata* W)
Thornless Honey Locust (*Gleditsia triacanthos inermis* W (southern half of zone)
Russian Olive (*Elaeagnus angustifolia* W)
Northern Red Oak (*Quercus borealis*)
Ponderosa Pine (*Pinus ponderosa* W)
Eastern Red Cedar (*Juniperus virginiana* W (eastern one-fourth of zone)
Rocky Mountain Red Cedar (*Juniperus scopulorum*)

Ornamental trees.

Carmine Crabapple (*Malus astrosanquinea*)
Purpleleaf Plum (*Prunus cerasifera pissardi*)
Pauls Scarlet Hawthorn (*Crataegus oxyacantha*)
Tea Crabapple (*Malus hupehensis*)
Amur Maple (*Acer ginnala*)
Paperbark Birch (*Betula papyrifera*) (northern two-thirds of zone)
Colorado Blue Spruce (*Picea pungens glauca*)
Eastern Redbud (*Cercis canadensis*) (southern one-fourth of zone)
Golden Rain Tree (*Koelreuteria paniculata*) (southern one-fourth of zone)
Buffalo Berry (*Shepherdia argentea*) (northern half of zone)

Shrubs.

Mugho Pine (*Pinus mugho mughus*)
Chinese Lilac (*Syringa chinesis* W)
Spirea (*Spiraea vanhouttei*) (except for northern one-fourth of zone)

Japanese Barberry (*Berberis thunbergii*)
(southern one-half of zone)
Lilac Chastertree (*Vitex agnus-castus*)
(southern one-third of zone)
Tatarian Honeysuckle (*Lonicera tatarica*) W
Armur Honeysuckle (*Lonicera maackii*)
Siberian Pea (*Caragana arborescens*) W
Peking Cotoneaster (*Cotoneaster acutifolia*)
Kashgar Tamarix (*Tamarix hispida*) W (southern one-third of zone)
Pfitzer Juniper (*Juniperus chinensis pfitzeriana*)
Goldenbell (*Forsythia intermedia*) (southern one-third of zone)
Winterberry Euonymus (*Euonymus bungeanus*) (southern one-third of zone)
Rock cotoneaster (*Cotoneaster horizontalis*)

15-65.3. *Zone 3 (Midwest).*

Shade and windbreak trees.

Red Maple (*Acer rubrum*) W
Norway Maple (*Acer platanoides*) W
Thornless Honey Locust (*Gleditsia triacanthos inermis*) W
Pin Oak (*Quercus palustris*) (not in Wisc., Minn., northern Iowa)
Scarlet Oak (*Quercus coccinea*)
Northern Red Oak (*Quercus borealis*)
White Oak (*Quercus alba*)
Common Hackberry (*Celtis occidentalis*) W
American Linden (*Tilia americana*) W
Russian Olive (*Elaeagnus angustifolia*) W
American Elm (*Ulmus americana*) W (where elm diseases are not serious)
White Pine (*Pinus strobus*) W
Austrian Pine (*Pinus nigra*) W
Norway Spruce (*Picea abies*)

Ornamental trees.

Flowering Dogwood (*Cornus florida*) (Illinois, Indiana, Ohio)
Eastern Redbud (*Cercis canadensis*) (southern half of zone)
Japanese Flowering Crab (*Malus floribunda*)
European Mountain Ash (*Sorbus aucuparia*)
Paperbark Birch (*Betula papyrifera*)
Blue Spruce (*Picea pungens-glauca*)
Flowering Cherry (*Prunus serrulata*) (Southern half of zone)
Cockspur Hawthorn (*Crataegus crusgall*) W
Purpleleaf Plum (*Prunus cerasifera pissardi*)

Shrubs.

Korean spice Viburnum (*Viburnum carlesii*)
Spirea (*Spiraea vanhouttei*)
English Hawthorn (*Crataegus oxyacantha*)
Japanese Barberry (*Berberis thunbergii*)

Snowberry (*Symphoricarpos albus*)
Weigela (*Weigela florida*) (southern half of zone)
Goldenbell (*Forsythia intermedia*) (southern half of zone)
Tatarian Honeysuckle (*Lonicera tatarica*) W
Siberian Pea (*Caragana arborescens*) W
Common Lilac (*Syringa vulgaris*) W
American Plum (*Prunus americana*) W
Black Haw Viburnum (*Viburnum prunifolium*) W
Chenault Coralberry (*Symphoricarpos chenaultii*)

15-6.5.4. *Zone 4 (Northeast)*

Shade and Windbreak trees.

Red Maple (*Acer rubrum*)
Sugar Maple (*Acer saccharum*)
Littleleaf Linden (*Tilia cordata*)
London Plane (*Platanus acerifolia*)
Ginkgo (*Ginkgo biloba*) (male only)
Tupelo or Sour Gum (*Nyssa sylvatica*) (southern half of zone)
Black Cherry (*Prunus serotina*)
White Oak (*Quercus alba*)
Red Oak (*Quercus borealis*)
Scarlet Oak (*Quercus coccinea*) (southern two-thirds of zone)
White Pine (*Pinus strobus*) W
Eastern Hemlock (*Tsuga canadensis*) W
Norway Spruce (*Picea abies*) W
White Fir (*Abies concolor*)

Ornamental trees.

Japanese Flowering Crab (*Malus floribunda*)
Paperbark Birch (*Betula papyrifera*)
Blue Spruce (*Picea pungens glauca*)
European Mountain Ash (*Sorbus aucuparia*) (northern half of zone)
Shadblow (*Amelanchier canadensis*)
Amur Maple (*Acer ginnala*)
American Holly (*Ilex opaca*) (southern half of zone)
Russian Olive (*Elaeagnus angustifolia*) (northern half of zone)
Washington Thorn (*Crataegus phaenopyrum*)
Flowering Dogwood (*Cornus florida*) (southern half of zone)
Gray Birch (*Betula populifolia*) (eastern half of zone)
Purpleleaf Plum (*Prunus cerasifera pissardi*)

Shrubs.

Common Lilac (*Syringa vulgaris*)
Spirea (*Spiraea vanhouttei*)
Japanese Barberry (*Berberis thunbergii*)
Arrowwood (*Viburnum dentatum*) W

Japanese Yew (*Taxus cuspidata*) W
Goldenbell (*Forsythia intermedia*) (southern half of zone)
Savin Juniper (*Juniperus sabina*)
Winged Euonymus (*Euonymus alata*)
Slender Deutzia (*Deutzia gracilis*) (southern half only)
Koreanspice Viburnum (*Viburnum carlesii*)
Sweet Mockorange (*Philadelphus coronarius*)
Purpleleaf Sandcherry (*Prunus cistena*)
Manchu Cherry (*Prunus tomentosa*)
Fragrant Sumac (*Rhus aromatica*)

15-6.5.5. Zone 5 (Southwest).

Shade and windbreak trees.

Arizona or Velvet Ash (*Fraxinus velutina*) W
Pepper Tree (*Schinus molle*)
Chinese Tallowtree (*Sapium sebiferum*)
Cottonwood (*Populus spp*) W
Balm of Gilead (*Populus candicans*)
Chinese Elm (*Ulmus pumila*) W
Pecan (*Carya illinoensis*)
Arizona Cypress (*Cupressus arizonica*) W
Eucalyptus (*Eucalyptus spp*) (Calif. and Ariz.)
Athel Tamarisk (*Tamarix aphylla*) W
Olive (*Olea europaea*) (Calif. and Ariz.)
Aleppo Pine (*Pinus halepensis*) W

Ornamental trees.

Redbud (*Cercis canadensis* or *reinformis*)
Italian Cypress (*Cupressus sempervirens*)
Greenwattle Acacia (*Acacia decurrens*)
Flowering Peach (*Prunus amygdalus persica*)
Crapemyrtle (*Lagerstroemia indica*)
Glossy Privet (*Ligustrum japonica*)
Chastetree (*Vitex agnus-castus*)
Carob (*Ceratonia siliqua*)
Jacaranda (*Jacaranda acutifolia*) (Calif. and Ariz. only)

Shrubs.

Pittosporum (*Pittosporum tobira*) W
Loquat (*Eriobotrya japonica*) W
Primrose Jasmine (*Jasminum mesnyi*)
Glossy Abelia (*Abelia grandiflora*)
Sylvester Juniper (*Juniperus chinensis sylvestris*)
Cenizo (*Leucophyllum frutescens*)
Sweet Viburnum (*Viburnum tinus*)
Pfitzer Juniper (*Juniperus chinensis pfitzeriana*)
Photinia (*Photinia serrulata*) W
Pyracantha or Firethorn (*Pyracantha coccinea*)
Chinese Holly (*Ilex cornuta*)
Burford Holly (*Ilex cornuta burfordii*)

15-6.5.6. Zone 6 (Central Southwest).

Shade and windbreak trees.

Chinese Elm (*Ulmus pumila*) W (not where root rot is serious)
Cedar Elm (*Ulmus crassifolia*) (east of 100 meridian)
Sugar Hackberry (*Celtis laevigata*) W
Arizona or Velvet Ash (*Fraxinus velutina*) (Central Texas only)
Pecan (*Carya illinoensis*)
Arizona Cypress (*Cupressus arizonica*) W (southern half of zone)
Thornless Honey Locust (*Gleditsia triacanthos inermis*) W
Cottonwood (*Populus spp*) W
Spanish or Texas Oak (*Quercus texana*) southern half of zone)
Eastern Red Cedar (*Juniperus virginia*) W
Live Oak (*Quercus virginiana*) (southern half of zone) W
Aleppo Pine (*Pinus halepensis*) W (southern half of zone)

Ornamental trees.

Flowering Peach (*Prunus amygdalus persica*)
Redbud (*Cercis canadensis* or *reinformis*)
Crapemyrtle (*Lagerstroemia indica*) (southern half of zone)
Japanese Privet (*Ligustrum lucidum*)
Purpleleaf Plum (*Prunus cerasifera pisardi*)
Loquat (*Eriobotrya japonica*) (southern half of zone)
Golden Rain tree (*Koelreuteria paniculata*)
Italian Cypress (*Cupressus sempervirens*) (southern half of zone)
Deodar Cedar (*Cedrus deodara*) (southern half of zone)

Shrubs.

Japanese Barberry (*Berberis thunbergii*)
Virburnum (*Viburnum suspensum*)
Glossy Abelia (*Abelia grandiflora*)
Pyracantha or Firethorn (*Pyracantha spp*)
Lilac Chastetree (*Vitex agnus-castus*) W
Pfitzer Juniper (*Juniperus chinensis pfitzeriana*)
Elaeagnus (*Elaeagnus pungens*)
Primrose Jasmine (*Jasminum mesnyi*)
Cenizo (*Leucophyllum frutescens*) (southern half of zone)
Burford Holly (*Ilex cornuta burfordii*)
Sweet Viburnum (*Viburnum tinus*)
Desertwillow (*Chilopsis linearis*) W
Photinia (*Photinia serrulata*) (southern half of zone)

Kashgar Tamarix (*Tamarix hispida*) W
Yaupon (*Ilex vomitoria*) (southern half of zone)
Feather Bamboo (*Bambusa vulgaris*) W (San Antonio and southward)

15-6.5.7. *Zone 7 (Midsouth).*

Shade and windbreak trees.

Willow Oak (*Quercus phellos*) W
White Oak (*Quercus alba*)
Southern Red Oak (*Quercus falcata*)
Scholartree (*Sophorajaponica*) W
Tuliptree (*Liriodendron tulipifer*) (east of Mississippi River)
Red Maple (*Acer rubrum*) W
Southern Magnolia (*Magnolia grandiflora*)
Loblolly Pine (*Pinus taeda*) W
Shortleaf Pine (*Pinus echinata*) W
Eastern Red Cedar (*Juniperus virginiana*) W (Do not use near apple orchards)
Littleleaf Linden (*Tilia cordata*)

Ornamental trees.

Flowering Dogwood (*Cornus florida*)
Redbud (*Cercis canadensis*)
American Holly (*Ilex opaca*)
Saucer Magnolia (*Magnolia soulangeana*)
Japanese Maple (*Acerpalmatum*)
Crapemyrtle (*Lagerstroemia indica*) (eastern and southern part of zone)
Purpleleaf Plum (*Prunus cerasifera pissardi*)
Flowering Peach (*Prunus amygdalis persica*)
Sourwood (*Oxydendrum arboreum*)
Deodar Cedar (*Cedrus deodara*) (southern and eastern parts of zone)

Shrubs.

Primrose Jasmine (*Jasminum mesnyi*)
Glossy Abelia (*A belia grandiflora*) W
Cotoneaster (*Co toneas ter spp*)
Pfizer Juniper (*Juniperus chinensis pfizeriana*)
Showy Jasmine (*Jasminum floridum*)
Azalea (*Azalea spp*)
Pyracantha or Firethorn (*Pyracantha spp*) W
Golden Bell (*Forsythia intermedia*)
Chinese Holly (*Ilex cornuta*)
Wax Ligustrum (*Ligus trum japonica*)

15-6.5.8. *Zone 8 (Southeast).*

Shade and windbreak trees.

Live Oak (*Quercus virginiana*)
Willow Oak (*Quercus phellos*) W
Water Oak (*Quercus nigra*) W
Southern Red Oak (*Quercus falcata*)
Pecan (*Carya illinoensis*) W
Southern Magnolia (*Magnolia grandiflora*)

Loblolly Pine (*Pinus taeda*) W
Longleaf Pine (*Pinus palustris*) W
Slash Pine (*Pinus caribaea*) W
Deodar Cedar (*Cedrus deodara*)

Ornamental trees.

Japanese Privet (*Ligustrum lucidum*) (southern half of zone)
Crapemyrtle (*Lagers troemia indica*)
Flowering Dogwood (*Cornus florida*)
Redubd (*Cercus canadensis*)
Mimosa (*Albizziajulibrissin*)
American Holly (*Ilex opaca*)
Flowering Peach (*Prunus amygdalis persica*)
Saucer Magnolia (*Magnolia soulangeana*)
Japanese Maple (*Acerpalmatum*)
Loquat (*Eriobotryajaponica*)

Shrubs.

Pyracantha or Firethorn (*Pyracantha ssp*) W
Chinese Holly (*Ilex cornuta*)
Primrose Jasmine (*Jasminum mesnyi*)
Glossy Abelia (*A belia grandiflora*) W
Photinia (*Photinia serrulata*) W
Wax Ligustrum (*Ligus trum japonica*)
Feather Bamboo (*Bambusa vulgaris*) W (costal areas only)
Southern Waxmyrtle (*Myrica cerifera*)
Azalea (*Azalea spp*)
Rock Cotoneaster (*Cotoneaster horizontalis*)

15-6.5.9. *Zone 9 (Caribbean).*

Shade and ornamental trees.

White Siris (*Albizzia procera*)
Flame Tree (*Delonix regia*)
West Indian Locust (*Hymenaea courbari*)
Queen of Flowers (*Lagers troemia speciosa*)
Royal Palm (*Roystonea borinquena*)
African Tuliptree (*Spathodea campanulata*)
White Cedar (*Tabebuia pallida*)
West Indian Almond (*Terminalia catappa*)
Angelin Tree (*Andira jamaicensis*)
Black Olive (*Brucida buceras*)
Laurel (*Ficus nitida*)
West Indian Mahogany (*Swietenia mahagoni*)
Lignum Vitae (*Guaiaicum officinale*)

Shrubs.

Chenille Copperleaf (*A calypha hispida*)
Painted Copperleaf (*Acalypha wilesiana*)
Bougainvillea (*Bougainvillea glabra*)
Croton (*Codiaeum variegatum*)
Poinsetta (*Euphorbia pulcherrima*)
Cape Jasmine (*Gardeniajasminoides*)
Caricature Plant (*Grap tohyllum pictum*)
Hibiscus (*Hibiscus spp*)
Firecracker Bush (*Ixora coccinea*)

Crapemyrtle (*Lagerstroemia indica*)
Nosegay Frangipani (*Plumeria rubra*)

Ornamental vines.

Adenocalymna (*Adenocalymna alliaceum*)
Allamanda (*Allamanda cathartica*)
Mountain Rose (*Antigonon leptopus*)
Bougainvillea (*Bougainvillea* spp)
Solomon Island Ivyarum (*Scindapsus aureus*)

15-6.5.10. *Zone 10 (Alaska, South of Anchorage).*

Shade and windbreak trees.

Sitka Spruce (*Picea sitchensis*)
White Spruce (*Picea glauca*)
Blue Spruce (*Picea pungens glauca*)
Engelmann Spruce (*Picea engelmanni*)
Alaska Cedar (*Chamaecyparis nootkatensis*)
Balsam Fir (*Abies balsamea*)
Western Red Cedar (*Thuja plicata*)
Western Hemlock (*Tsuga heterophylla*)
Mountain Hemlock (*Tsuga mertensiana*)
Scotch Pine (*Pinus sylvestris*)

Ornamental trees.

European Larch (*Larix decidua*)
Eastern Larch (*Larix laricina*)
Red Alder (*Alnus rubra*)
Paper Birch (*Betula papyrifera* var. *neoalaskana*)
Balsam Poplar (*Populus tacamahaca*)
European Mountain Ash (*Sorbus aucuparia*)
Sitka Mountain Ash (*Sorbus sitchensis*)
White Willow (*Salix alba*)
Bebb Willow (*Salix bebbiana*)

Shrubs.

Tatarian Honeysuckle (*Lonicera tatarica*)
Siberian Pea (*Caragana arborescens*)
Siberian Dogwood (*Cornus alba sibirica*)
Juneberry (*Amelanchier alnifolia*)
Sitka Alder (*Alnus sinuata*)
Peking Cotoneaster (*Cotoneaster acutifolia*)
Siberian Crab (*Malus baccata*)
European Birdcherry (*Prunus padus*)
Common Lilac (*Syringa vulgaris*)
Pacific Serviceberry (*Amelanchier florida*)

15-6.5.11. *Zone 11 (Alaska, Talkeetna, Palmer, and Anchorage Climate Type).*

Shade and windbreak trees.

White Spruce (*Picea glauca*)
Blue Spruce (*Picea pungens glauca*)
Norway Spruce (*Picea abies*)
Lodgepole Pine (*Pinus contorta*)
Scotch Pine (*Pinus sylvestris*)
Eastern Tamarack (*Larix laricina*)
Black Cottonwood (*Populus trichocarpa*)
Balsam Poplar (*Populus tacamahaca*)

Paper Birch (*Betula papyrifera*)
Quaking Aspen (*Populus tremuloides*)

Small trees.

Boxelder (*Acer negundo*)
Native Willows (*Salix* species)
Thinleaf Alder (*Alnus incana*)
European Mountain Ash (*Sorbus aucuparia*)
Pacific Serviceberry (*Amelanchier florida*)
Serviceberry (*Amelanchier alnifolia*)
Siberian Crab (*Malus baccata*)
Red Siberian Crab (*Malus* spp)
European Birdcherry (*Prunus padus*)
Silber Buffaloberry (*Shepherdia argentea*)

15-6.5.12. *Zone 12 (Alaska, Fairbanks Climate Type).*

Trees.

White Spruce (*Picea glauca*), native sources only
Tamarack (*Larix laricina*), native sources only
Siberian Larch (*Larix sibirica*)
White Birch (*Betula papyrifera*), native sources only
Quaking Aspen (*Populus tremuloides*), native sources only.
Balsam Poplar (*Populus tacamahaca*), native sources only

Small trees and large shrubs.

Boxelder or Manitoba Maple (*Acer negundo*)
European Mountain Ash (*Sorbus aucuparia*)
Thinleaf Alder (*Alnus incana*)
Native Willows (*Salix* species)
Juneberry (*Amelanchier alnifolia*)
Highbush Cranberry (*Viburnum pauciflorum*), native sources only
American Highbush Cranberry (*Viburnum trilobum*)
Tatarian Honeysuckle (*Lonicera tatarica*)
Siberian Crabapple (*Malus baccata*)
Silverberry (*Elaeagnus commutata*)
Chinese or Late Lilac (*Syringa villosa*)

Medium and small shrubs.

False Spirea (*Sorbaria sorbifolia*)
Billiard Spirea (*Spiraea billiardii*)
Spirea (*Spiraea stevenii*), native sources only
Hansa Rose (*Rosa rugosa*)
Red Leaved Rose (*Rosa rubrifolia*)
Common Juniper (*Juniperus communis*)
Creeping Juniper (*Juniperus horizontalis*)
Labrador Tea (*Ledum* species)

Shrubs.

Tatarian Honeysuckle (*Lonicera tatarica*)

Redosier Dogwood (*Cornus acutifolia*)
Peking Cotoneaster (*Cotoneaster acutifolia*)
European Cotoneaster (*Cotoneaster integrifolia*)
Blackberried Cotoneaster (*Cotoneaster melanocarpa*)
Silverberry (*Elaeagnus commutata*)
Siberian Pea (*Caragana arborescens*)
Late Lilac (*Syringa villosa*)
Common Lilac (*Syringa vulgaris*)
False Spirea (*Sorbaria sorbifolia*)
Red Elderberry (*Sambucus canadensis*)

15-6.5.13. Zone 13 (Hawaii).

Shade Trees.

Formosa Koa (*Acacia confusa*)
Golden Shower (*Cassia fistula*)
Pink and White Shower (*Cassia javanica*)
Pink Shower (*Cassia grandis*)
Monkey Pod, Rain Tree (*Samanea saman*)
Chinese Banyan (*Ficus retusa*)
Jacaranda (*Jacaranda acutifolia*)
Pink Tacoma (*Tabebuia pentaphylla*)
Kiawe (*Prosopis* spp.)
Crapemyrtle (*Lagerstroemia indica*)
False Kamani (*Terminalia catappa*)
Paper Bark (*Melaleuca leucadendron*)

Shrubs.

Panax (*Nothopanax foylei*)
Star Jasmine (*Jasminum multiflorum*)
Tiare (*Gardenia taitensis*)
Ixora (*Ixora macrothyrsa*)
Turks Cap (*Malvastrum arboreum*)
Red Hibiscus (*Hibiscus rosa-sinensis*)
Snowbush (*Breynia nivosa*)

Tree Fern (*Cibotium chamissoi*)
Red Ginger (*Alpinia purpurata*)
Canna (*Canna indica*)

15-6.6. *Plant Lists (Ground Covers).*

Note: The following narrated information on ground cover plants should be coordinated with the tabulated information in table 15-3.

15-6.6.1. *Aaron's beard (Hypericum calycinum).* Aaron's beard is evergreen in the south, semi-evergreen around Washington, D.C. Its underground runners and fibrous roots form a dense, nonerodible mass on steep banks. Its spread is more rapid in full sun. Abundant yellow flowers appear in midsummer. For neat appearance cut the old wood to ground level occasionally.

15-6.6.2. *Akebia, five-leaf (Akebia quinata).* This twining vine easily smothers shrubs and small trees. Like Hall's honeysuckle it has gone wild in some places. Do not plant it near woods. Akebia rapidly develops an effective ground cover or, if allowed to cover a fence, a screen.

15-6.6.3. *English ivy (Hedera helix).* There are many forms and varieties of this vine. The variety Baltic is the hardiest. Slow to start, it requires much weeding for a year or two. Best growth is attained by yearly feeding and light additions of compost or peat moss.

15-6.6.4. *Bayberry (Myrica pennsylvanica).* If the grey fruits are desired, plants of both sexes are required. This plant is effective on the lee side of sand dunes. It makes an effective ground cover with its stooling, spreading habit. Inland it is treated as a shrub for informal screens and group plantings. Although deciduous it holds its leaves until mid-winter. In the deep south *M. cerifera*, a more tender species, is much used.

Table 15-3. Ground Covers

Plant Name ¹	Light	Size	Soil	Habit rate of spread	Use	Zones	Spacing
Aaron's beard (s) Hypericum calycinum	Sun & part shade	1'	Average	Rhizomatous Fast	Banks	1,3,4, 7,8	2'X2'
Akebia, five-leaf (d) Akebia quinata	Sun	Vine	Moist	Twining Fast	Banks not near woods	1,3,4 7, 8	4'X4'
English ivy (e) Hedera helix	Shade & part shade	6-10'	Average Moist	Mat & Clinging. Fast	Banks, foundations	3,4,7	1'X1'
Bayberry (d) Myrica pennsylvanica	Sun	5-10'	Sandy acid	Stooling Moderate	Dunes, screens, banks	3,4, 7	5'X5'
Bearberry (e) Arctostaphylos uva-ursi	Sun	6-12"	Rocky sites, acid sands	Trailing Slow 1st yr.	Dunes, banks	1, 2, 3, 4,7	3'X3'
Boston ivy (d) Parthenocissus tricuspidata	Sun to shade	Vine	Average	Climbing Fast	Walls, banks -	3, 4, 7	2'X3'
Carpet bugle (e) Ajuga reptans	Sun & part shade	4-6'	Average	Matting Moderate	Improved grounds	3,4,7	1'X 1'
Coralberry (d) Symphoricarpos orbiculatus	Sun & part shade	2-3'	Dry, thin	Rhizomatous Moderate	Seashore, banks, borrow pits	3, 4, 7	3'X3'
Crown vetch (s) Coronilla varia	Sun	1-2'	Average	Rhizomatous Moderate	Non-mowable slopes or seed	*	18"X18'
Day lilies (h) Hemerocallis sp.	Sun	2-3'	Moist clay	Sun or shade Moderate	Banks, seeps, culverts	3, 4, 6, 7, 8	2'X2'
Fleecflower (h) Polygonum Reynoutria	Sun or shade	1-2'	hot dry, med. to sandy	Rhizomatous Fast	Non-mowable sites	2,3,4, 5,6,7,8	2'X2'
Forsythia, "Arnold Dwarf" (d) Forsythia X spp.	Sun & part shade	3'	Average	Arching, stooling Fast	Banks, screens	3, 4, 7	3'X3'
Forsythia, drooping (d) Forsythia suspensa	Sun & part shade	6-8'	Shallow moist	Arching Fast	Banks, walls	3, 4, 7	6'X6'
Hollygrape, creeping (e) Mahonia repens	Part shade	1'	Moist to dry	Slow	Banks, imp. Grounds	1	3'X3'
Honeysuckle, Hall's (s) Lonicera japonica haiana	Sun & part shade	Vine	Moist, average	Mats, climbs Fast	Banks, slopes, roads	3, 4, 5, 6,7	3'X3'
Ice plant (e) Mesembryanthemum spp.	Sun	6-12"	Dry, sandy	Carpet Fast	Banks, roads	1, 5	1'X1'
Japanese spurge (e) Pachysandra terminalis	Shade	6-12"	Moist organic	Rhiz. Mats Moderate	Improved grounds	1,3,4, 3, 7,8	1'X1'
Juniper, creeping (e) Juniperus horizontalis	Sun - part shade	6"-2'	Dry acid to normal	Trailing Slow	Shallow rocky banks Improved grounds	3, 4, 7	4'X4'
Juniper, Sargent (e) Juniperus chinensis sargentii	Sun	12-14"	Dry acid to normal	Spreading Moderate	Shallow rocky banks	1, 3,4, 7	4'X4'
Juniper, shore (e) Juniperus conferta	Sun	12-18"	Sandy dry	Spreading Moderate	Shore establishment and dunes	1, 3,4, 7	3'X3'
Lantana, trailing (d) Lantana montevidensis	Sun	to 4'	Dry, hot	Trailing Fast	Banks	2, 5, 6	4'X4'
Lavender cotton (e) Santolion spp.	Sun	12-20'	Dry, hot sandy	Bunching Fast	Banks, parking lots small areas	5,6	2'X2'

See footnote at end of table.

Table 15-3. Ground Covers-Continued

Plant Name ¹	Light	Size	Soil	Habit rate of spread	Use	Zones	Spacing
Lily turf(e) Liriope supp.	Sun & shade	3-12"	Moist to dry Moderate	Sod former small areas	Under trees, banks	5,6,.7,	1'X1'
Lippia (e) Lippia canescens	Sun	2-4"	Dry well drained	Matting Moderate	Sub. for lawns	.2,5	1'X2' sods
Locust, bristly (d) Robinia fertilia	Sun	4-6'	Sandy-rocky well drained	Rhizomatous Fast	Banks, roads, min spa	3, 4, 7	6'X6'
Matrimony vine (d) Lycium halimifolium	Sun	3-5"	Moist, organic	Sprawling Fast	Walls, borrow pits	1,3,4, 7	5'X6'
Myrtle, periwinkle le) Vinca minor	Shade	6-10'	Moist loam	Rhizomatous Moderate	Under trees, shady banks, imp. grounds	1,3,4, 5, 6, 7	1'x1'
Rock cotoneaster (a) Cotoneaster horizontalis	Sun, part shade	2-3'	Well drained	Spreading Fast	Imp. grounds, half shade in Cal., banks	1, 3, 4, 7	3'X3'
Rose, memorial is) Rosa wichuraiana	Sun	2'	Moist to dry	Vine to 20' Fast	Seashore, banks, roads	3, 4, 7, 8	3'X3'
Snow-in-summer (e) Cerasteum tomentosum	Sun & part shade	3-6'	Well drained to droughty	Matting Fast	Improved grounds, slope	1, 3, 4, 7, 8	18 X 18
Sumac, smooth id) Rhus glabra	Sun	9-15'	Dry, poor	Thicket Fast	Unimproved lands, banks	3, 4, 7	6'X6'
Sumac, fragrant (d) Rhus aromatica	Sun	3-4'	Well drained	Stooling Moderate	Banks, roads, seaside	3,4,6, 7, 8	4'X4'
Sun rose (s) Helianthemum nummularium	Sun	6"-2'	Neutral moist, dry	Stooling Slow	Imp.grounds,banks, small areas	1,4,7, 8	1'X1'
Thyme) Thymus serpyllum	Sun, part shade	4-5'	Dry to Average	Creeping Slow	Imp. grounds,small areas	1,3,4, 5, 7	1'X1'
Virginia creeper (d) Parthenocissus quinquefolia	Sun-shade	Vine	Sandy, normal	Running Fast	Dunes, rock outcrops	3, 4, 5, 6, 7, 8	2'X2'
Winter creeper (e) Evonymus fortunei radicans	Sun, part shade	3-5'	Average to dry	Creeping tacking Moderate	Walls, banks	1,3,4, 5, 6, 7, 8	2'X2'
Winter creeper, purple leaf (e) Evonymus fortunei coloratus	Sun, part shade	6-12"	Average to dry	Creeping Moderate	Under trees, borders banks	1, 3, 4, 5, 6, 7, 8	2'X2'
Yellowroot (d) Zanthorhiza simplissima	Part shade	12-14"	Moist, Woody	Rhizomatous Slow	Moist, woody border	3,4,7,	1'X 1'

¹(d) deciduous, (e) evergreen, (h) herbaceous, (s) semi-evergreen
* See paragraph 15-6.6.9

15-6.6.5. *Bearberry (Arctostaphylos uva-ursi)*. It is one of the finest evergreen ground covers for light, droughty, acid soils. Slow to start, a single plant will spread from 10 to 12 feet. Use container-grown stock only. Light peat moss mulching is beneficial. Feed with acid forming fertilizers only, e.g., ammonium sulfate. Leaves turn reddish bronze in the winter.

15-6.6.6. *Boston ivy (Parthenocissus tricuspidata)*. This vine is more adapted to climbing masonry and stone buildings than a ground cover. It is substituted occasionally on concrete and masonry retaining walls. It does not mind smoky city conditions. Its brilliant fall foliage is one of the attractions.

15-6.6.7. *Carpet bugle (Ajuga reptans)*. This well known and widely used plant forms an almost weed-free mat. Generous organic additions to the planting site prior to planting reduces coverage time. Most varieties bronze in winter.

15-6.6.8. *Coralberry (Symphoricarpos orbiculatus)*. This native rhizomatous shrub is a weed called "Buckbrush" in the Midwest. Its usefulness in stabilizing poor, shallow sites on banks, borrow pits and gullies is not to be denied. Interplanted into a thin grass stand, it spreads as the grass cover declines. New construction cuts can be planted to coralberry and over-seeded with the bunch forming Chewings red fescue for erosion control

15-6.6.9. *Crown vetch (Coronilla varia)*. Crown vetch is a low-growing perennial legume used for erosion control on embankments, usually on slopes too steep to mow. Its special rea of adaptation is the limestone derived high-phosphate soils of Pennsylvania and Ohio, southward to Kentucky. The species is more difficult to establish and maintain on other soil sites and normally other species of plants should be used. North- and east-facing slopes, especially in the southern parts of its range, are more favorable to its survival The colorful flowers make the plant popular wherever it can be used successfully. Plants may be established with both seed and nursery-grown crowns. Seed is preferred for most planting conditions.

15-6.6.10. *Day lilies (Hemerocallis spp.)*. Many improved varieties are on the market but the old original *H. fulva* does the conservation job. Above culvert headers, along stream banks and seep areas it thrives: once established, mowing maintenance of these areas is eliminated. The fleshy roots give this plant good drought tolerance.

15-6.6.11. *Fleeceflow dwarf (Polygonum rey-noutria)*.

Good for large areas where winter neatness is not a factor, since there are a lot of dead tops each fall and winter. Fertilize yearly until a complete cover is attained. Thereafter little or no fertilizer is required and complete erosion control is attained. Brilliant fall foliage follows the profusion of pink blooms.

15-6.6.12. *Forsythia, "Arnold Dwarf" (Forsythia X spp.)*. This plant is small and compact. It arches with the tips rooting where they contact the ground. Bloom is very sparse compared to other Forsythias. It will be invaded by tree species from seed dropped by birds. It stagnates in poor, sour and droughty soils. It needs occasional feeding to keep it vigorous.

15-6.6.13. *Forsythia, drooping (Forsythia suspensa)*. Because of its long, pendulous or trailing branches its use should be limited to plantings along the top of high headwalls, retaining walls, bridge abutments and stream banks. Once established it furnishes each spring a pure cascade of gold. Flower buds sustain winter injury in the northern range of this plant. For a fast start the planting pits should be back filled with an enriched soil mix.

15-6.6.14. *Hollygrape, creeping (Mahonia repens)*. Use in landscape plantings on small areas. The rate of spread is slow. Even though this is the hardiest of the Mahonias, the foliage winter burns easily unless the plants are in protected spots.

15-6.6.15. *Honeysuckle, Hall's (Lonicera japonica halliana)*. The further north in its zone of adaptation, the more acceptable is this plant. The further south, the more rampant it becomes and more objections are raised. Confined and occasionally mowed, it makes a perfect bank cover. Maintenance may involve removal where it starts to climb trees. Overgrown areas have been renovated by concentrated grazing with cattle or sheep.

15-6.6.16. *Ice plant (Mesembryanthemum)*. Actually several genera are involved in the plants called Mesembryanthemum by the trade. Most are perennials, but a few are annuals. Once established they self-sow. Plantings on droughty soils in full sun will require some irrigation. The perennials should be cut back occasionally to induce bloom. A few degrees below freezing point causes injury.

15-6.6.17 *Japanese spurge (Pachysandra terminalis)*. Widely used, this plant grows in partial to full shade. High organic acid soils with peat moss top-dressings help keep it neat and compact. Sandy droughty soils and full exposure to the sun are no good. The plant must

have moisture at all times. Fallen leaves from adjacent trees should be removed.

15-6.6.18. *Junipers (Juniperus spp.)*. The horizontal mat-forming species should be spaced to permit spread without crowding. The bare ground between plants should be heavily mulched with wood chips, stone or similar material. Many cultivated strains are available. Choice should be made on the basis of locally proven performance and size of area to be planted. Use container-grown or balled and burlapped plants. Junipers are particularly suited to sunny, dry sites. They rank among the best of the evergreen ground covers.

15-6.6.19. *Lantana, trailing (Lantana montevidensis)*. It grows rapidly with a spread of 5 to 6 feet. It is highly drought resistant and requires full sun. Container-grown stock is more reliable than bare-root stock. An occasional pruning is needed to stimulate new branches and increase leaf canopy.

15-6.6.20. *Lavender cotton (Santolina spp.)*. The grey form is *S. chamaecyparissus*; the green form, *S. viridis*. They should be used only in very difficult dry, hot areas of small size. Pruning is needed yearly to overcome an open, ragged appearance.

15-6.6.21. *Lily turf (Liriope spp.)*. Lily turf and its counterpart Mondo grass (*Ophiopogon*) form a rough grass-like carpet. They complete well with shallow-rooted trees and are effective in sun and shade. Slow to start, they need weeding until the blanket is tightly woven. Annual spring fertilization speeds up coverage. After establishment, fertilize only when the leaves show yellowing. Bare-root plant divisions make satisfactory stock. Both species are mowable at a 3-inch height.

15-6.6.22. *Lippia (Lippia canescens)*. This drought tolerant, ground-hugging creeper is a lawn substitute in arid climates. Plant 2-inch sods on 1- by 2-foot or 2- by 2-foot spacings. Occasional mowing evens the stand and removes the flowers frequented by bees. Annual spring fertilization should be done. Top-dressing with humus or compost improves the stand. Zero temperatures cause considerable injury.

15-6.6.23. *Locust, bristly (Robinia fertilis)*. Since this species produces seed, 1-year seedling stock is planted. *Robinia hispida* (Roseacacia) is mostly sterile. Planting stock of this is made from root suckers called mallet cuttings and look like an inverted "T." Both plants form thickets 4 to 6 feet tall. Bristly locust seedlings give the best stands. Plantings of mallet cuttings are often disappointing. It will spread 20 feet underground in 2

years in light, sandy soils. This plant is best used on nonmowable areas like high rocky banks, borrow pits and other unimproved grounds needing a vegetative cover.

15-6.6.24. *Matrimony vine (Lycium halimifolium) and Chinese matrimony vine (L. chinense)*. These are shrubs with long trailing branches. Both are excellent soil stabilizers on banks and other sites where refined plantings are not required. In rich soils they may become weedy. One-year-old bare-root stock is used. Add one-half ounce of nonburning fertilizer to the bottom of each planting hole. In some locations these plants are attacked by red spiders.

15-6.6.25. *Myrtle or periwinkle (vinca spp.)*. Big-leaf periwinkle (*Vinca major*) is larger-growing, more tender and not as compact as the more widely used common periwinkle (*V. minor*). Both species perform best in partial shade on humus-filled soil. Occasional fertilization following establishment of a solid cover is advisable. Should leaf disease attack, mow to ground level and remove the clippings. Fertilize lightly. Recovery growth will be rapid. These plants can be used as an understory with tall shrubs on slopes to provide erosion control and eliminate mowing.

15-6.6.26. *Rock cotoneaster (Cotoneaster horizontalis)*. This is an excellent horizontal branching semi-evergreen shrub. Container-grown stock should be used. Although forming an attractive mat, it never gets dense enough to keep out weeds. Other species and varieties of prostrate cotoneasters are in the trade, like *C. dammeri* and *C. microphyllt*. All are susceptible to blight, borers, and scale. Use only with the advice of the local horticulturist.

15-6.6.27. *Rose, memorial (Rosa wichuraiana)*. This is also called Wichura rose. This glossy green, semi-evergreen, prostrate plant has a wide range of adaptability from New York to seaside plantings in Texas. Although it produces 10-t to 15-foot runners, close spacing (3-foot) should be used to attain quick coverage, thereby reducing weeding costs. Like all roses it prefers deep, well drained sites and responds to organic nitrogen.

15-6.6.28. *Snow-in-summer (Cerasteum tomen tosum)*. Best for small areas, this silvery grey mat requires some yearly maintenance for best effects. Mow after bloom to stimulate new growth. After a complete cover is established very little fertilizer should be used. It likes moist loams and clay loams better than sands. It grows dense enough to minimize weeds. Planting stock can be

purchased as single plant divisions or flats of rooted plants.

15-6.6.29. *Sumacs (Rhus spp.)*. The natives, (*Rhus glabra*, *R. copallina* and *R. typhina*) are the volunteers on subsoil sites and abandoned fields where seed sources are available. One-year-old bare-root seedlings are used. Direct seeding on slopes and road banks has been partially successful. Protect and encourage volunteers. Plant only unimproved grounds. Besides tolerating adverse sites, they provide winter wildlife food. More refined than the natives is fragrant sumac (*R. aromatica*). Tough, hardy and spreading underground, it is adapted to a wide range of sites from banks to seaside plantings. Its uses are: low screens, to lessen headlight glare, direct traffic, stabilize banks, and camouflage unsightly scars.

15-6.6.30. *Sun rose (Helianthemum nummularium)*. A refined, semi-evergreen plant best used as a landscape subject. It prefers a moist rich soil but shows some drought tolerance. Slow to start, it will spread to 3 feet. Varieties of many colors are available. Container-grown plants are most reliable.

15-6.6.31. *Thyme, creeping (Thymus serpyllum)*. Tolerant of drought and neglect, it is best mowed occasionally to maintain density. It is a low, dense, fragrant ground cover growing best in full sun. It is suitable only for small improved areas. Spring plantings are advised.

15-6.6.32. *Virginia creeper (Parthenocissus quinquefolia)*. This native climbing vine is not used much since it rarely makes a dense mat and is deciduous. It is effective on the lee side of sand dunes. It volunteers in abandoned gravel pits and will drape itself over rock outcrops. It grows well in shady locations.

15-6.6.33. *Winter creepers (Evonymus spp.)*. A very effective evergreen ground cover, much used but highly susceptible to Oyster Shell and Evonymus Scale. Minor attacks can be controlled by timely sprays. Where attacks are heavy, cut to the ground line or destroy the planting. Consult a horticulturist or landscape architect before planting *Evonymus* species.

15-6.6.34. *Yellowroot (Zanthorhiza simplisissima)*. A native of shady stream banks from Pennsylvania to Georgia, the flowers appear in spring before the leaves emerge. Best used in small areas on moist sites. Although rhizomatous its rate of spread is slow. It has been used effectively on road medians where a low, neat, foot-high cover is desired.

15-6.7. Plant Material Standards.

15-6.7.1. *Size*. Use of large planting stock is seldom justified. Plant materials in smaller sizes survive better than larger stock, are less expensive, and often reach mature size as soon as does the larger stock. The following heights are satisfactory for most plant materials:

Shade trees: 10 to 12 feet.

Evergreen trees (coniferous): 2/2 to 3 feet.

Evergreen shrubs (upright type): 1 1/2 to 2 feet.

Ornamental flowering trees: 4 to 5 feet.

15-6.7.2. *Use of native collected materials*. Nursery-grown stock can usually be transplanted more successfully than collected plants since collected plant roots are often damaged in the transplanting process. Collected trees from local timbered areas may be used if the work is supervised by trained personnel so that desired species and sizes are selected, the plants are dug properly, and plantings are made at the proper season. Deciduous stock to be collected should be marked while the leaves are present (before frost) so that specimens of the desired variety are obtained. Use paint or strips of colored cloth for marking. Selection of small trees is more important when using collected stock than when nursery-grown stock is provided. Even if a large tree survives transplanting, a smaller tree will often outgrow it and have better appearance within a few years. Evergreens such as holly, magnolia, and conifers should be moved with a ball of earth. During the first growing season, collected materials require more irrigation and control of grass and weeds than does nursery-grown stock. The plant must be watered periodically whenever rainfall is deficient.

15-6.7.3. Purchased planting stock.

15-6.7.3.1. *Balled or bare-rooted*. In purchase contracts specify balled and burlapped (B and B), containers (Cont), or bare-rooted (BR). Most deciduous plant materials may be planted bare-rooted during the proper planting seasons.

15-6.7.3.2. *Labeling*. Specify that stock be labeled as to species and variety. Labels should permit ready identification by labor foreman and should be of material and permanence to assure identification for at least 60 days. The purchase agreement should contain both common and scientific names.

15-6.7.3.3. *Shipment and delivery*. Plan shipments of planting stock to permit immediate planting as far as possible. If convenient, inspect stock at the nursery to

assure that the material has been grown under satisfactory conditions, freshly dug, and properly packed for shipment. Packing should protect the stock from freezing or drying. Make sure that balls or containers are not loosened or broken in shipment and that there are no broken branches nor abrasions on the bark.

15-6.7.3.4. General appearance. Stock should conform to type for the species desired and should be healthy and free of insects and disease. The foliage should be thrifty, resilient, and moist to the touch. Reject overage material plants with poorly balanced branching, weak-stemmed plants, and other material not well proportioned or fully branched.

15-6.7.3.5. Guarantees. Stock should be guaranteed as to species and variety ordered and freedom from those diseases and insects for which there are laws or quarantines. Strong initial growth should be guaranteed, although the cost of a guarantee of a full season's growth is seldom justified.

15-6.7.3.6. Height and spread or caliber relationships. Specify height and spread or height and caliber relationships. The following guides are useful, but may need adjustments for particular species required. These relationships agree in general with "American Standard for Nursery Stock," prepared by the American Association of Nurserymen, Inc. (app. E). Top and root balance should be analyzed carefully when the purchase specifications are prepared.

Conifer trees. (Examples: white pine, ponderosa pine, hemlock, deodar cedar, Norway spruce)

Height (feet)	Spread (feet)	Minimum ball size (inches)
1 to 1 1/4	3/4 to 1	10
1/2 to 2	1 to 1 1/2	11
2 1/2 to 3	1 1/2 to 2	13
4 to 5	2 1/2 to 3 1/2	17

Standard shade trees.

Minimum height (feet)	Caliber (inches)	Minimum ball size (inches)
7 to 9	1 to 1/4	16
10 to 12	1 to 1 1/4	20
12 to 14	2 to 3	24
14 to 16	3 to 3 1/2	32

Note: Unless otherwise specified, standard shade trees are to be free of branches to a point not to exceed 60 percent of their actual height. Height of branching should be in good balance with size of trunk and kind of tree. Trees with double or multiple leaders should not be accepted.

Ornamental trees. (Flowering dogwood, redbud, crapemyrtle, flowering crab, American holly.) The following represent caliber: height: number-of-branches relationships. Height is the governing measurement. For single-stem plants the caliber: branching relationship will

usually be as follows:

Minimum height (feet)	Caliber (inches)	Minimum ball size (inches)	Minimum number branches
2 to 3	5/16	12	3
3 to 4	7/16	13	4
4 to 5	9/16	15	5
5 to 6	11/16	16	6

Evergreen shrubs. (Conifers and broadleaf.)

Spreading and semispreading types. (Horizontal juniper, pfitzer juniper, jasmine, mugo pine, rock cotoneaster.) Measurement should be average spread and not greatest diameter. The following represent branch spread: ball size relationship.

Average branch spread (inches)	Minimum ball size (inches)
12 to 15	9
15 to 18	10
18 to 24	11

Globe or dwarf types. (Globe arborvitae, English boxwood, Japanese holly, snowberry and dwarf yew.) The following represent height: spread relationship and recommended ball size for each height:

Height (inches)	Minimum spread (inches)	Ball size (inches)
12 to 15	10	9
15 to 18	12	10
18 to 24	15	11
24 to 30	18	12

Upright type. (Upright yew, pittosporum, Japanese holly, myrtle, cenizo.) The following represent height: spread relationships and recommended ball size for each height.

Height (feet)	Minimum spread (inches)	Ball size (inches)
1 1/4 to 1 1/2	9 to 15	10
1 1/2 to 2	12 to 18	11
2 1/2 to 3	18 to 24	13
3 to 4	21 to 30	15

Deciduous shrubs. (Deutzia, mock orange, Japanese barberry, spiraea.) The following represent height: cane relationships. (Balls may not be required for fast growing species.)

Height (feet)	Minimum number of canes
1 to 1 1/2	3
2 to 3	4

15-6.7.3.7. Sizes of balls for trees and shrubs. The ball sizes may be ignored where plants are purchased in cans or other containers.

Less than 20 inches. Balls with diameters less than 20 inches should have a depth not less than 75 percent of diameter.

Twenty to thirty inches. Balls with diameters of 20 to 30 inches should have a depth not less than 66 percent of diameter.

Thirty-one to forty-eight inches. Balls with diameters of 31 to 48 inches should have a depth not less than 60 percent of diameter.

Larger than 48 inches. Percent of depth of larger balls should be scaled proportionately.

Note: See publication at appendix A, no. 17, entitled "Planting and Establishment of Trees, Shrubs, Ground Covers, and Vines."

15-6.8. Planting Seasons. The following rules apply generally to time of planting:

15-6.8.1. Plant deciduous trees and shrubs while vegetative growth is inactive. This excludes May and June for northern latitudes and April, May, and June for southern latitudes.

15-6.8.2. Plant evergreens in northern zones in late summer after new growth has hardened, and in the spring about the time new leaf growth begins. Plant evergreens in southern zones in early fall to permit root development before cold weather, and in the spring when new leaf growth begins.

15-6.8.3. Avoid all plantings in the southern half of the United States during midsummer to reduce loss of plants due to rapid transpiration.

Note: See paragraph 15-6.16 for use of anti-desiccants as a transplanting aid and protectorant prior to adverse weather situations.

15-6.9. Planting Procedures.

15-6.9.1. Temporary storage:

Dig the tree pits before the trees arrive so trees are out of the ground no longer than necessary. Large balled and burlapped trees should be placed in the holes directly from the truck.

If the plants must remain out of the ground for a few days, cover the balls of earth with soil to prevent drying of the roots near the surface.

Cover the roots of bare-root trees and shrubs with wet burlap or similar material as soon as they are unloaded if planting is to take place within a few hours.

Heel in other bare-root trees and shrubs at once in a trench deep enough and wide enough for the roots of the plants. Place them at a 45° angle, and cover the roots with soil to prevent drying. If shrubs are delivered in bundles, keep the bundles intact to facilitate future handling. Handle plants carefully to avoid injury. When

removing heeled-in plants, un-cover roots carefully. Do not grasp the tops of the plants and pull them out of the trench without removing the soil. Heel in the plants as near as possible to the planting site, preferably where water is available. Water heel-in stock periodically, but do not wash the soil from the roots when watering.

15-6.9.2. Pits:

In digging planting pits for trees, separate the soil into three piles: sod, topsoil subsoil Use the salvaged sod elsewhere to repair grassed areas. Arrange the piles to keep open the side of the pit from which the tree will be placed. If existing soil consists of sand or gravel or contains excessive building refuse, discard the material removed from holes and use good quality clay or silt loam.

Dig pits wide enough to accommodate all the roots without crowding or twisting. Prepare all pits with straight sides. Dig tree pits at least 2 feet wider than the spread of roots or ball of earth. Dig tree pits at least 2 feet deep or deep enough to permit at least 6 inches of topsoil below the roots. Deeper planting prevents enough air from reaching the roots and may kill the tree.

Shape the pit bottom so that the center is slightly raised for proper drainage. Place at least 6 inches of compacted topsoil in the bottom of the pit.

15-6.9.3. Setting balled plants:

Handle balled plants carefully. Lift plants by the ball, not by the plant stem, to avoid breaking the earth from the roots. After the plant is set, loosen the burlap from the top of the ball or cut away. Remove plants from metal containers with care to avoid damaging the root system. Use tinshears to cut the sides of the can to permit the plant to be lifted from the container. Lift from underneath the soil block, not by the plant stem.

Set all plants plumb before backfilling. Damage to plants may result from air pockets formed under the roots when the tree or shrub is moved after the backfill has been placed.

Soil is firmed about the roots, but not packed, while it is added to fill the hole.

15-6.9.4. Backfilling:

Backfill the space between balled and burlapped plants and side of planting pit with good loam top-soil Work soil under the ball to eliminate air pockets. Place backfill in 6-inch layers, using the salvaged topsoil. Firm each layer until the planting pit is half filled. If the soil is dry, fill the remainder of the pit with water to settle the backfilled soil. Allow the water to penetrate, fill the planting pit with soil, and firm the upper soil lightly.

After placing the backfill under and around a bare-root tree or shrub, add enough topsoil to cover the roots and add water until the soil reaches the consistency of a thick liquid. Gently raise and lower the tree to allow the soil to fill in between the fibrous roots. Continue adding soil and water until the planting pit is filled to grade.

Note: See chapter 8 for "Soil Mixes" and "Topsoil and Soil Mixes".

15-6.9.5. Depth of planting. Plant trees and shrubs so that the ground line is the same as at the nursery. This line is usually well marked by contrasting light- and dark-colored bark. In cool, humid areas, there should be no depression around the plant, especially for soils having slow drainage. In arid zones, a saucer-like depression is necessary to permit irrigation. Where practicable in arid zones, grade to collect storm runoff at planting sites. For spring plantings in humid zones, make an earth ring about three inches high around the plant to hold water. Omit earth rings for late fall plantings, and level existing rings to prevent collection of water that may freeze the plants.

15-6.9.6. Staking. Stake all trees that are subject to damage from wind. Stakes are useful also to protect newly planted material from traffic, mowing equipment, and similar hazards. Except for large trees (20 feet or taller) where rigid supports are required, avoid the use of long guy wires that affect ease of lawn maintenance and endanger personnel safety. Drive stakes within 2 feet of plants. Use stakes long enough so that, after driving, stakes are at least half as high as the plant:

Protect the bark of the plant by placing scrap rubber hose around the tree at the point of contact of supporting wires. If scrap rubber hose is not available, use fairly thick cloth wrappings, or laths cut 6 inches long.

Cut 12-gauge wire in proper lengths and draw it through the rubber hose or around the protective collar until the cut ends meet. Pull the ends of the wire around the stakes near the top until taut. Wrap the cut ends around the stake and twist them together on the inside of the stake. Secure tree to the second stake in the same way. To give added tension, use a rack stick between the doubled wire. Keep tension on all wires equal.

Stake tree-like shrubs and small evergreen trees with single stakes placed on the side toward the prevailing winds. Set the stake about 1 foot from the trunk and about 2 feet deep. When planting bare-root stock, drive the stake before setting the plant to prevent injury to the roots. If 1/2-inch rope is used instead of wire and hose, cross the rope between the stake and tree, wrap loose ends once around the stake, and tie in place

with a square knot.

15-6.9.7. Pruning after transplanting. Prune trees at the time of planting to improve structure and to reduce top growth to compensate for roots lost in moving. Do not prune trees that have been pruned at the nursery. Start at the top of the tree and work down. Remove closely parallel branches, crossed and broken limbs, and superfluous growth at the base of the main branches:

When removing a branch, make the cut flush with the main branch. Do not leave a short stub, because the healing callus cannot close over the stub, which decays and may permanently injure the tree. When cutting back a branch, cut to a bud so as not to leave a stub. Paint all pruning wounds over 1 inch in diameter with a tree-wound compound to retard checking and decay of the exposed wood.

Do not cut back the central leader. When the terminal bud is removed, the one nearest the cut becomes the terminal bud. On trees with opposite buds, each bud produces a shoot that competes with the other, and a structurally weak double-leader tree results. Cutting back the leader of an oak tree flattens the top and stunts the tree.

15-6.9.8. Vines. Plant field-grown vines by digging individual pits at least 16 inches deep and 1 foot greater in diameter than the ball or spread of roots. Place at least 6 inches of topsoil under the plant. Firm the soil around the roots with the hands until the planting pocket is filled. Remove pot grown vines from the containers carefully to avoid breaking the soil around the roots.

15-6.10. Special Windbreak Plantings. Certain soil and climatic conditions require special windbreak design and maintenance. In areas of high winds and low rainfall, such as the western plains, several staggered rows of trees and shrubs may be required for a windbreak. Put the taller, fast-growing trees in the center rows, conifers in intermediate rows, and shrubs at the edges. This design provides early effectiveness, snow accumulation within the wind-break to conserve moisture, and shade to help control weeds. The tall rapid-growing species also give early protection to the slower-growing plants that might be destroyed by high winds.

15-6.10.1. Windbreak plantings are usually developed with nursery stock 6 to 18 inches in height (not including the root). When planting, use a straight spade to force the soil back. Insert the roots to the desired depth, remove the spade, and press the soil into place with the foot. Dry soil must be watered. Where large stock is

use the procedures in paragraph 15-6.9.

15-6.10.2. Under arid conditions, irrigate to keep plants thriving. Choose sites carefully to take advantage, where possible, of sandy loam soils, locations where runoff can be expected, and areas where the water table is within reach of tree roots.

15-6.10.3. Control of wind erosion in the vicinity of the windbreak is essential as windblown dust and sand may destroy an expensive newly planted windbreak within a few hours. Protect plantings exposed to drifting soil and high winds with snow fences until growth is well established. Control exposed soils by using annual or perennial grasses, anchored mulch, or crushed rock or gravel.

15-6.10.4 Control of water erosion may also be necessary where windbreak rows cross steep slopes. Provide terraces and paved flumes where necessary.

15-6.11. *Protection from Equipment.* Young trees are easily damaged by maintenance equipment, especially power mowers. Large mature trees may also be injured. Instruct the operators frequently regarding use of equipment in planted areas. If necessary, place stakes near trees.

15-6.12. *Irrigation.* Tree and shrub plantings usually require watering during the first summer after planting. Weekly irrigation from a garden hose or water truck is adequate. Plantings, made in humid, timbered zones seldom require irrigation after the first summer. In arid zones, do not neglect fall and winter irrigation. Guiding surface drainage into parks or recreation areas by means of terraces reduces or eliminates the need for irrigation. Trees established in irrigated lawns usually get sufficient water.

15-6.13. *Cultivation.* Cultivation controls weed growth and conserves moisture. A mulch is superior to cultivation in humid sections, particularly for shrubs and shrub groups. Some cultivation at the base of trees and shrubs is required where there is little summer rainfall. See tables 7-1 and 7-2 for mulch material.

15-6.14. *Pruning.* Pruning will be supervised to prevent injury to plants. Typical injuries caused by improper pruning are: stubs of tree branches, stripped bark adjacent to pruning wounds, shrub branches cut off at the ends rather than at their origin, and removal of lower limbs of specimen conifers and of shrubs. Most ornamental shrubs and shade trees may be pruned at any time of the year. Exceptions are noted in 15-6.14.2. below. Fertilize after severe pruning to assist the plant in recovery.

15-6.14.1. *Shrubs.* Prune shrubs by removing the older canes at their bases rather than by clipping the ends of

the branches. Remove part of the old growth each year to renew a shrub that consists entirely of old canes. Heavy annual pruning of most shrubs is undesirable since it is expensive and in the case of flowering shrubs may destroy the wood that produces flowers:

Old shrubs sometimes require pruning to force them to renew their growth. Heavy pruning for neglected flowering shrubs may be necessary to encourage continued blooming.

Prune shrubs that produce blooms on new wood (such as *Abelia*) during the winter. Prune shrubs producing blooms on older wood (*Goldenbell* and *Spiraea*) after blooming.

Severe pruning is usually desirable for bare-rooted shrubs at the time of planting to bring root and top growth into better balance.

15-6.14.2. *Shade and Ornamental Trees.* To avoid frequent re pruning, anticipate tree growth for 2 years and prune accordingly:

Prune young shade trees to produce a sturdy framework.

Remove lower branches of shade and deciduous trees gradually as the tree develops to encourage a well developed crown. Remove branches broken by wind or ice.

Do not remove the lower branches of ornamental conifers and broadleaf evergreens.

Prune shade trees to resist damage by wind and ice.

Remove branches that extend over buildings and endanger roofs, eaves, and windows or hang within eight feet of sidewalks and private drives. Prune trees along streets to provide clearance for buses, moving vans, and similar vehicles.

Cut back branches that overhang or grow into power lines. Anticipate the effects of ice and wind on branches which might fall on power lines. Shape the entire tree rather than notch the top.

Remove dead or broken branches and those that turn back toward the center of the tree. Thin out branches that interfere with each other. Plan cuts to leave wide crotches rather than narrow ones. Wide crotches are more resistant to damage from wind and ice.

Paint wounds more than 1 inch in diameter. Obtain tree-wound paint if considerable repair of large trees is anticipated; otherwise an outside lead paint is satisfactory.

If a branch cannot be held up with one hand while

sawing with the other, undercut the branch 1 foot from the trunk and saw off the branch just outside the undercut (fig. 15-4). (This procedure removes most of the weight of heavy limbs and prevents stripping the bark.) Make the final cut flush with the trunk.

Prevent multiple leaders from developing on central stem trees such as conifers and holly.

When severe pruning is necessary to correct extensive damage or neglect, prune during dormant periods or in the early spring to permit recovery while growth is rapid. This is specially important for broadleaf evergreens.

Trees such as maple, birch, and dogwood, which tend to bleed excessively during dormancy, should be pruned during the growing season.

Remove strangling roots.

15-6.14.3. Vines. Prevent the older stems from becoming unsightly by occasional renewal of vine growth. Remove stems that choke each other. Remove and destroy vines that persistently enter or cling to window frames, screens, eaves, and other structural components of a building.

15-6.14.4. Safety precautions. An employee experienced in tree pruning will supervise the pruning of large trees to prevent injuries to members of the crew. Suitable safety precautions include-

Never work alone while pruning large trees.

Use adequate 1/2- or 3/4-inch rope for securing the climber while he is removing the limbs. One end of the rope extends to the ground for use of the ground-man and the climber in the exchange of tools or supplies. Assign a ground man the job of assuring that the rope does not become fouled with cut branches or get in the way of traffic if the tree is near a street or road. Cut large branches by segments, especially in the upper parts of the tree to permit control when severed from the trunk.

15-6.14.5. Repair of Tree Injury. To repair extensive damage caused by wind and ice storms-

Remove broken limbs smoothly to provide satisfactory conditions for the wound to heal.

Remove loose or torn bark cleanly.

Shape the edges carefully to permit drainage of rain water from the wound (fig. 15-5). This helps to prevent rot and permits rapid healing of the injury. Paint the raw edges of the bark with shellac immediately after making a cut, to prevent drying.

15-6.15. Fertilizing. Trees and shrubs need feeding in areas where farm crops require fertilizers. Where the

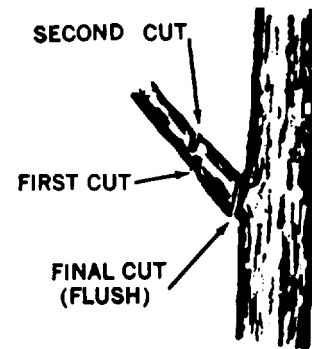

Figure 15-4. Method of removing a large limb. Final cut is made flush to allow wound to heal and avoid rot and insect infestation.

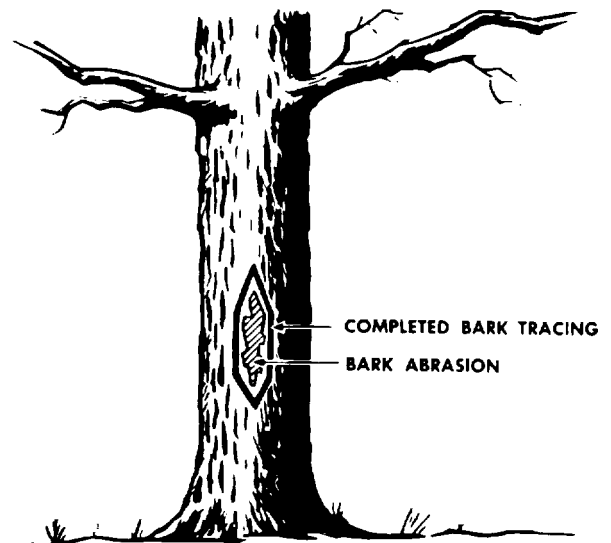

Figure 15-5. Bark tracing of abrasion on trunk of tree.

soils are relatively fertile, trees and shrubs in lawn areas may not need fertilizers since the conditions that produce good turf also produce healthy woody plants. Fertilizer rates vary with conditions, but 1 pound per inch of tree diameter for each tree and 1/4 to 1 pound for each shrub, depending on height, may be applied safely. Repeat the treatment until the desired results are achieved. If tree or shrub does not respond to repeated treatment, determine if its condition can be traced to the

physical characteristics of the soil, such as a clay "hardpan" subsoil or underlying rock layer, rather than its fertility. Apply a complete fertilizer (2-1-1 ratio) occasionally to acid or neutral soils. Use phosphate sparingly in soils having a pH of 6.0 or more since yellowing by chlorosis may result. Fertilizer is best applied in holes spaced throughout the concentrated root zone of the tree. This zone extends from the base of the tree to a few feet beyond the lower branches.

15-6.16. Anti-desiccants. Anti-desiccants are substances which, when sprayed on plant surface tissue, form films that reduce the loss of water from the plant tissue. However, they remain permeable to gas interchange, allowing escape of oxygen and the intake of carbon dioxide from the air.

15-6.16.1. Uses. Uses for these emulsified vinyl resins include:

15-6.16.1.1. Preventing water loss from plants during transplanting, thus increasing the chance of survival.

15-6.16.1.2. Protecting leaves, bark, and fruit from both drying winter winds and summer drought.

15-6.16.1.3. Immobilizing soft-bodied insects such as aphids and preventing reinfestation.

15-6.1.4. Serving as a sticker for pesticides and herbicides, thus increasing residual action. This use is still experimental.

15-6.16.2. Types. Anti-desiccants are manufactured by several companies under trade names such as Wiltpruf NCF, Exhalt 410, Plantgard, Mobileaf, Vapor Gard, and Nu-film. These formulations vary somewhat in the degree of viscosity of the emulsion. The more viscous materials form a thicker film, but they may not spread as easily and effectively.

15-6.16.3. Application. Anti-desiccant material is purchased as a concentrate and diluted at different rates for use as a transplanting aid and winter protectorant, according to the manufacturer's directions on the label. Plants marked for transplanting survive best when sprayed from 1 to 7 days in advance of digging.

15-6.17. Fruit Inhibitors. It may be desirable to prevent certain fruits from developing on trees in order to eliminate messy appearance, rank odors, or cleanup problems. Mulberries, ginkgos, and ailanthus trees are common offenders. The use of chemicals to prevent fruit set is still in the experimental stage and is not generally recommended.

15-6.171. Apples. The concentration of chemicals in a spray solution must be determined for each apple variety. Too small concentrations are ineffective and

cause too great injury to the leaves and growing shoots. However, high concentrations are necessary for complete fruit inhibition, with the greater risk of foliage injury. Materials which have been used to spray apples at or shortly after petal-fall include:

15-6.17.1.1. Naphthalene acetic acid (NAA) at the rate of 10 to 25 p.p.m. plus one pound of carbaryl (50%) in 100 gallons of water.

15-6.17.1.2. Naphthaleneacetamide (NAAD) at the rate of 50 p.p.m. in 100 gallons of water.

15-6.17.1.3. Carbaryl (50%) at the rate of one to two pounds in 100 gallons of water, according to the variety.

15-6.17.2. Other fruits. Other species of trees vary widely as to the concentration of chemicals that is effective without causing undue harm. The rate must be determined experimentally before large-scale application. Otherwise, foliage injury and plant mortality may result. Dinitro compounds are occasionally used as inhibitors. The caustic action destroys the stigmas (pollen-receiving organs) of the blossoms, prevents pollen germination, and inhibits pollen tube growth.

15-6.17.3. Application. The application of any of the above chemicals (paras. 15-6.17.1. and -6.17.2.) must occur during calm periods since wind drift can result in severe damage to other plants in the vicinity. Application should be accomplished only after coordination with the local agricultural extension agent or other specialists familiar with specific chemicals and their effect on tree species and varieties.

15-6.18. Grading. Some trees are sensitive to any important change in the depth of soil over their roots. This characteristic is apparently more serious in high rainfall areas and clay soils. Two or three inches of waste soil spread over a wooded area may destroy the entire planting. Three general methods of protecting trees when ground grades are changed are discussed in paragraph 7-5.2.1.8 and are illustrated by figures 7-2, 7-3, and 7-4.

15-7. Golf Course Maintenance.

15-7.1. Design. Designs for golf courses should be drawn up, or approved, by a golf course architect to assure adequate layout and economical maintenance of greens and fairways. Obtain professional advice on selection of grasses from the turf agronomist at the U.S. Department of Agriculture Extension Services Office for the State in which the installation is located.

15-7.2. Planning. Prepare a plan and report before starting construction or making changes in existing courses. Evaluate the need for the course, on the basis of the number of people expected to use it and the availability of other local courses for use by military personnel. In the report state total costs, including costs of: clearing and grading; greens construction; fairway construction; planting and fertilizing of grasses, trees, and shrubs; irrigation system and connection to existing mains; new wells where water supplies are not adequate; maintenance equipment; and consulting and engineering costs. Estimate maintenance costs, including the number and salaries of laborers required, salary of superintendent, supplies, and utilities.

15-7.3. Maintenance. The care of the greens, tees, and fairways requires the services of a trained golf course greenskeeper. The grounds crew for the golf course should consist of people who can be assigned regularly to this work, so that they may be trained in the specialized duties and proceed with routine maintenance without risk of destroying or damaging the valuable turf.

15-7.3.1. Maintenance of greens. Greens maintenance is the key to the value of the entire course, for usually at least half the strokes in a round of golf are played on the greens.

15-7.3.1.1. Mowing. Mowing must be done with a special putting green mower capable of smooth, clean cutting at a height of 3/16 inch. Greens must be mowed four to six times each week during the growing season to keep them in satisfactory playing condition and prevent the formation of a mat. Brushing, raking, and vertical mowing are also considered good maintenance practices to aid in preventing the development of this mat and the diseases and water problems associated with it. All clippings should be removed.

15-7.3.1.2. Watering. Watering must be frequent enough to keep the grass green and growing slowly but continuously throughout the growing season.

15-7.3.1.3. Fertilization. Fertilization with nitrogen fertilizers will be necessary three to five times during the growth period, the first application made in very early spring and the last one near the end of the season except on regions subject to snow mold. The amounts will vary with conditions and length of the growing season, but a total of 4 to 8 pounds of nitrogen for each 1,000 square feet of green will be required for the entire season. Phosphorous and potash fertilizers should be applied as needed to meet the nutrient requirements of the grass. The fertilizer must be evenly spread over the surface at each application and watered into the soil as soon as applied.

15-7.3.1.4. Top dressing. Top dressing of greens is the means by which the surface is kept true and surface creeping stems are kept covered. Top dressing is done with a compost made by mixing sand, organic matter, and soil in about the same proportions as those recommended for preparing the original green soil. The compost should be treated to eliminate any viable weed seed. Cyanamid has been used for this purpose, 13 pounds of the chemical being mixed with 1 cubic yard of compost. Lime, if needed, should be incorporated in the compost when mixed, and the entire mixture allowed to stand for four to six weeks in a moist condition before being used. Compost must be screened to remove all lumps, stones, and debris before application. The amount of compost applied as top dressing will usually not exceed 1/5 cubic yard per 1,000 square feet of green surface at any one application. Two to four applications may be required per year to maintain the desired surface. Compost is worked into the green surface by dragging with a large flexible door-mat or similar device.

15-7.3.1.5. Aerification. Aerification insures firmness and resilience, and reduces compaction and puddling even under constant traffic. Especially on heavy soils, compaction and subsequent puddling are most prevalent on tees and greens.

15-7.3.1.6. Disease, insect, and rodent control. Disease, insect, and rodent control on greens are highly specialized operations. The types of insects and diseases affecting the greens vary with the region and the type of grass present. Some of the principal destructive insects are cutworms, armyworms, grubs of the May beetle, and Japanese beetles. Primary turf diseases are dollarspot, brown-patch, snowmold, pythium, and copperspot. Control of both insects and diseases are usually accomplished by the skilled use of chemicals. Details of this program must be left in the hands of the greenskeeper. Unless adequately accomplished, disease and insects may nullify all other work and result in greens that are virtually useless. General information on insect and rodent control is found in "Military Entomology Operational Handbook" (app. A, no. 10).

15-7.3.2. Maintenance of tees and fairways. Care of tees and fairways will generally resemble that given lawns,

except that all operations are modified as necessary to permit use of power equipment. Tees will require additional care in the application of top dressing and seed to heal the scars on the used portions of each tee whenever the markers are moved to a new location. Preventive maintenance in the form of fertilization, mowing, watering, and insect control before turf is badly damaged will greatly reduce the cost of turf management. Fairways and tees should receive 100 to 200 pounds of nitrogen per acre each year, depending on soil and climatic conditions as well as length of growing season. Phosphoric acid and potash should be applied as needed, but rarely over 40 pounds of each per acre during the year. Heavy soils under continuous traffic tend to become puddled and compact when the soil moisture content is high, and it may be necessary to aerate some turf areas periodically. Soil aeration is most likely to become inadequate on the areas where foot traffic is concentrated and continuous in all kinds of weather. Tee markers should be moved frequently to allow grass to heal from foot and club damage. Tees on short holes on which "irons" are used should have markers moved more often than those on which "woods" are used. Frequency will depend on amount of traffic and condition of the turf.

15-7.3.3. Maintenance of "rough" areas. "Rough" areas are less likely to retard players if they are mowed two to four times during the growing season. Mowing seedling stands need not begin until grass reaches a height of 6 to 8 inches. Mowing height should never be shorter than 3 inches.

15-7.3.4. Maintenance of traps. The maintenance of traps is important to the effectiveness of a golf course. The quality of their condition is indicative of the maintenance given to the whole course. Traps should be prevented from becoming hard and compact. Sand should be raked smooth in lines parallel to the edges of the green. Grass at edges of traps and water hazards should be mowed by hand machines. If traps cannot be adequately maintained, they should be replaced with grass covered swales.

15-8. Airfield Maintenance.

15-8-1. Vegetated areas must be protected from unauthorized traffic and maintained by fertilizing (see chap. 8) and by proper mowing (see para. 15-13). Bare areas and damage to safety zone turf through accident or unauthorized traffic must be repaired immediately. Where turf cannot be grown, non-crusting oil palliatives (see chap. 7) will be applied as required, usually twice a year.

15-8.2. Traffic control is essential and should be

regulated by directives. Vehicle parking areas, trafficways to strategic sites, and special servicing areas should be clearly designated, thereby providing boundaries for areas requiring grounds maintenance.

15-9. Roadside Vegetation.

15-9.1. Maintenance. Roadside vegetation, both herbaceous and woody, can be managed to enhance base attractiveness and provide scenic values in addition to fulfilling the prime purposes of soil stabilization, wind modification and as sound barriers. The following guidelines should be considered and applied where applicable:

15-9.1.1. Confine close mowing (under 8 inches) to road shoulders.

15-9.1.2. Encourage flowering plants indigenous to the geographic location of the installation.

15-9.1.3. Encourage trees and shrubs to take over backslopes completely or in irregular bed type arrangements where compatible with safety visibility.

15-9.1.4. Trees and shrubs will be preserved unless they present a traffic hazard.

15-9.1.5. Planting of trees and shrubs will be regulated so they will not interfere with reasonable future widening or improvement, maintenance operations, overhead utility lines, or vision. at intersections, railroad crossings, or inside of curves.

15-9.1.6. Overhanging branches will be trimmed to provide a minimum vertical clearance. All unsound and dead limbs overhanging the roadway will be removed. Trees that interfere with vision or side clearance will be trimmed or removed. Dead trees, and trees with weakened roots or top support, which might endanger traffic by falling across roadway, will be removed.

15-9.1.7. Signs, markers, headwalls, guardrails, and bridge approaches will be kept completely visible, both in front and behind.

15-9.1.8. Brush or shrubs will not be permitted to grow under bridges or at inlets or outlets of drainage structures.

15-9.1.9. The ground under and around timber structures will be kept free of dry brush, weeds and other inflammable materials.

15-9.1.10. Fertilize herbaceous type vegetation often enough (annually if necessary) to maintain soil stabilization.

Note: For additional information on roadside vegetation maintenance see "Maintenance and Repair of Surface Areas" (app. A, no. 7).

15-10. Maintenance of Antenna Facilities.

15-10.1. The control of density and height of vegetation are important factors related to the operational efficiency of the facility. The zone of clearing usually includes all the area encompassed by the antenna, supports, guys, and transmission lines. Reasonable care should be taken to maintain the facility sites as originally prepared. Siting criteria and site preparation are specified in applicable technical orders or by specific requirements expressed by communications engineering-installation agencies. Care will be exercised during maintenance to prevent damage to antenna systems by vehicles or other machines.

15-10.2. The clearing standards for antenna areas will normally allow tree stumps and vegetation approximately 2 feet in height. Vines should not be allowed to grow on any building or antenna support. Special criteria are necessary for some areas.

15-10.3. The clearing and standards for maintenance of high frequency type antenna areas are as follows:

15-10.3.1. Doublet antenna:

15-10.3.1.1. Minimum cleared areas at each end of the antenna will be equal to the height of the antenna element.

15-10.3.1.2. The cleared areas broadside to the antenna element will extend outward a minimum distance of six times the height of the antenna element and equal in width to the length of the antenna plus twice the height of the antenna element.

15-10.3.1.3. An obstruction slope clearance at a minimum of six to one will be maintained on the sides and ends of the cleared areas to a distance of six times the height of the antenna.

15-10.3.2. Rhombic antennas:

15-10.3.2.1. The minimum length of the area to be cleared in front of the rhombic antenna is a function of the mean height of the antenna curtain above the terrain which determines the vertical radiation angle of the antenna. The higher the antenna, the lower the radiation angle of the main antenna lobe.

15-10.3.2.2. The width of the cleared area must be equal to the width of the antenna installation plus 10 degrees on each side of the antenna in the direction of radiation. The cleared area will extend in front of the antenna a distance of 10 times the average height of the antenna curtain.

15-10.3.2.3. An obstruction slope clearance at a minimum of 6 to 1 will be maintained on the sides and 10

to 1 on the end of the cleared area, to a distance of 10 times the average height of the antenna curtain.

15-10.3.3. Horizontal log periodic antennas:

15-10.3.3.1. The minimum length and width of the area to be cleared will be equal to the width of the antenna installation, and extend forward from the rear support towers at a minimum of 35 degrees on both sides of the antenna in the direction of radiation for a distance of 10 times the height of the antenna.

15-10.3.3.2. An obstruction slope clearance at a minimum of 6 to 1 will be maintained on the sides of the cleared area and a minimum of 10 to 1 at the end of the cleared area in the direction of radiation to a distance of 10 times the height of the antenna.

15-10.3.4. Horizontal rotatable log periodic antennas:

15-10.3.4.1. An area with a minimum radius 10 times the height of the antenna array, centered on the antenna support tower, will be cleared.

15-10.3.4.2. An obstruction slope clearance at a minimum of 10 to 1 will be maintained from the end of the cleared area to a distance of 10 times the height of the antenna array for the full 360 degree coverage.

15-10.3.5. Vertical log periodic antenna array:

15-10.3.5.1. Minimum length and width of the area to be cleared in front of the antenna (nominal 110 degree beamwidth) will be equal to the width of the antenna installation or ground screen (ground screen always required on quarter-wave vertical monopoles but not always required on half-wave vertical dipole log periodic antennas) and extending forward at a minimum of 60 degrees on both sides of the antenna to a distance of 500 feet beyond the front of the antenna.

15-10.3.5.2. An obstruction slope clearance at a minimum of 6 to 1 will be maintained at the sides of the clearance area and a minimum of 20 to 1 at the end of the clearance area in the direction of radiation out to a minimum distance of 2000 feet.

15-10.3.6. Vertical broadband omni-directional antenna:

15-10.3.6.1. An area with a minimum radius of 500 feet from the center of the antenna will be cleared.

15-10.3.6.2. Beyond the 500 foot radius there will be an obstruction clearance slope at a minimum of 20 to 1 outward to a distance of 2000 feet from the edge of the clearance area.

15-10.4. The clearing and standards for maintenance of low frequency type antennas are as follows:

15-10.4.1. Vertical antenna masts:

15-10.4.1.1. Vegetation removed to permit the installation of a buried ground system, or an above ground counterpoise system, will be completely free of stumps. Vegetation should not be allowed to grow over 1 foot high.

15-10.4.1.2. The area of a copper-mesh ground system (associated with helix buildings) must be free of all vegetation, including low-cut grass. Crushed stone or gravel may be used for dust and erosion control when necessary.

15-10.4.1.3. Beyond the copper-mesh area for a distance of 150 feet radius, vegetation no higher than 1 foot is permissible.

15-10.4.2. Beverage antennas:

15-10.4.2.1. A cleared area 30 feet each side of the antenna system should be maintained.

15-10.4.2.2. Stumps are permissible up to 2 feet in height but with no live growth, such as bushes, branches, or vines.

15-10.4.3. Large loop antennas:

15-10.4.3.1. A clearing area with a radius of 75 feet is required, or to the extent of the length of the radials of the ground system.

15-10.4.3.2. Vegetation within the cleared area will not exceed 2 feet in height.

15-10.4.4. Small loop antennas:

15-10.4.4.1. When pole-mounted 25 feet or higher, a cleared area with a radius of 25 feet is required.

15-10.4.4.2. Vegetation within the cleared area will not exceed 2 feet in height.

15-10.5. Transmission Lines:

15-10.5.1. Low-power open-wire transmission lines require a cleared area 10 feet on each side of the line.

15-10.5.2. High-power open-wire transmission lines are associated with high-power low-frequency radio facilities. These should have a cleared area 50 feet on each side of the line.

15-10.6. Radar and Microwave Facilities:

15-10.6.1. Special criteria are usually not required for radar and microwave installations beyond that established locally as normal maintenance of grounds and conformance with good housekeeping standards.

15-10.6.2. The scope of vista between antennas and service areas must be clear of vegetation at all times.

15-10.7. *Control Tower Facilities.* Shrubbery should be kept below line-of-sight between antennas and service areas and should not physically interfere with feed lines,

guys, or masts.

15-10.8. Navigational Aid Facilities:

15-10.8.1. Instrument landing systems localizer facility:

15-10.8.1.1. Care should be taken to maintain the sites as originally prepared.

15-10.8.1.2. No objects or stumps may be larger than 2 feet in diameter. Such objects must not be symmetrically spaced in a pattern of lines or rows. Nothing may extend above the plane between the antenna base and the end of the runway.

15-10.8.1.3. The area forward of the directional antenna array and within 15 degrees on either side of the extended runway centerline should remain free of large surfaces, such as embankments or boulders, within 2,000 feet. The maximum allowable height of reflecting surfaces more than 2,000 feet away is 1/100, as measured from the localizer site.

15-10.8.1.4. The area inclosing the directional antenna array, the clearance antenna array, equipment trailer, course and clearance monitors must remain free from farm machinery, livestock, people, etc. Farming in this critical zone must be prohibited.

15-10.8.1.5. In the area bounding the critical zone, cultivation of crops may be permitted subject to the following limitations:

15-10.8.1.5.1. The height of crops should not exceed approximately 2 feet. (This is roughly the height of such crops as hay, wheat or oats.)

15-10.8.1.5.2. The boundaries of the critical zone should be clearly marked and pointed out to prospective users of the controlled area. Fencing is not recommended as a method of marking.

15-10.8.1.5.3. Strick adherence to the clearance around the monitors must be observed.

15-10.8.2. *Instrument landing system glide slope facility.* The area forward of the glide slope antenna for at least 1,200 feet or to the runway end if more than 1,200 feet, and bounded on the sides by the ILS runway centerline and line running parallel and at lateral distance of 750 feet thereto should be maintained as initially prepared.

15-10.8.3. Instrument landing system marker beacon facility:

15-10.8.3.1. All trees, stumps, shrubbery, brush, weeds, debris, or other obstructions within the limits of the areas occupied by the structure and its appurtenances and on each side of the site perimeter will be cleared.

15-10.8.3.2 The area surrounding the site should be free of growth which is more than 1 foot in height for each 2 feet of distance from the marker beacon.

15-10.8.4. *TVOR and VOR facilities.* Under ideal site conditions for VOR/TVOR facilities, the area within a radius of 2000 feet from the facility should be cleared to ground level. This is impossible in most cases, and sites not cleared to this degree are acceptable. (For specific details see the general notes on sheet 1 of Standard Air Force Working Drawing AW-86-16-21.) The practical criteria for site selection, land acquisition, and maintenance easements are essentially as set forth below. The sites should be maintained as originally prepared and as they existed at the time of the commissioning flight check. Certain local conditions as to land acquisition and easements may preclude actual grounds maintenance by base personnel in all the areas described below, but in all cases where the Air Force has the responsibility for maintenance, these conditions will apply.

1-10.8.4.1. *TVOR.*

16-10.8.4.1.1. The area within a 15-foot radius from the edge of the TVOR counterpoise will be treated with soil sterilizer and covered with a minimum of 3 inches of gravel crushed stone, or similar locally available material.

15-10.8.4.1.2. The area between the 15-foot radius and a 200-foot radius from the TVOR antenna must remain free from vehicles, farm machinery, and cattle. Crops, vegetation, brush, or weeds in this area may not exceed 18 inches in height.

15-10.8.4.1.3. Within the area between the 200-foot radius and 750-foot radius from the TVOR antenna, normal pasture and crop raising, excluding trees, is permissible.

15-10.8.4.1.4. Within the area between 750- and 2000-foot radius from the TVOR antenna, obstructions must be removed whose height exceeds a positive angle of elevation greater than 1 degree from the center of the site.

15-1.8.4.2. *VOR:*

15-1.8.4.2.1. Area within the fence inclosure (60 feet by 60 feet) will be cleared of all obstructions. To prevent brush fire within this area, the height of grass and weeds will not be permitted to exceed 18 inches.

15-10.8.4.2.2. Area between the fence and 200-foot radius from the VOR antenna should remain free from vehicles, farm machinery, and cattle, insofar as practicable. If farming is practiced within this area, the height of crops should not exceed about 4 feet.

15-10.8.4.2.3. Within the area between the 200-foot

radius and 750-foot radius from the VOR antenna, normal pasture and crop raising is permitted. No obstructions will be permitted in this area and all trees will be removed.

15-10.8.4.2.4. Within the area between the 750-foot radius and the 1500-foot radius from the VOR antenna, no vegetation above the height of 15 feet is permitted. No obstructions or trees will be permitted to extend above a vertical angle of 2 degrees, measured from the ground level at the antenna.

15-10.8.4.2.5. From 1000 to 2000 feet no groups of trees should be permitted whose height exceeds a vertical angle of 2 degrees from the ground level at the antenna.

15-10.8.4.3. *VOR (mountain top site):* Within the limits of the level area around the antenna counterpoise, grub out all stumps and subsurface roots larger than 3 inches in diameter. No grazing or crop raising will be permitted within this cleared area.

15-10.8.5. *TACAN facilities.* The antenna of this facility is mounted at the top of a vertical pole or support, varying in height according to surrounding terrain. Height of vegetation adjacent to the support will not exceed a point 12 feet below the base of the antenna and may increase outwardly on an angle of 3 degrees.

15-10.9. Suitable roads will be maintained to provide access to sites for the performance of clearing and maintenance operations.

15-11. Magazine (Earth Covered) Maintenance.

Earth covered ammunition storage magazines, mostly constructed with 1 1/2 on 1 slopes, are subject to damage from rain, wind and rodents. Failure of original seedings are usually due to lack of a maintenance program, incorrect species, or damage from mowing equipment. Where failures have occurred, find the cause. Where steep slopes prevent maintenance of an acceptable erosion resistant cover, reduce the slope angle by adding fill at the toe. Use new construction procedures to reestablish cover. Select species suitable for embankments in the region involved. (See para. 15-5.8.) Maintain a minimum soil cover of 2 feet over all concrete structures. Where hand mowing is required because of slope steepness, consider planting Crown vetch, vines, or similar plants in adapted regions to reduce maintenance costs. (See para. 15-6.6.) Maintain the earth covered magazines and a 50 foot perimeter

around them as semi-improved grounds. Keep free from flammable debris. Maintain other areas in the ammunition storage area as unimproved grounds. Mow for fire control or out-lease for cattle grazing. Maintenance must be coordinated with respective Service safety manuals. In some arid and semi-arid regions a vegetative cover cannot be maintained. In such instances sterilize the slopes as needed and cover with aggregate. The minimum depth of aggregate cover is 2 inches. Use locally available aggregate which is resistant to weathering and graded as follows:

Passing 1-inch sieve-100%

Passing 3/4-inch sieve-60 to 90%

Passing 2/4-inch sieve-0 to 20%

Also, for these arid areas, an alternate method is the use of a loose covering of gunite, asphalt, or similar material. The important consideration for these materials is that they pulverize in the event of an accidental explosion. A mixture combined with straw, bark, or comparable material would be suitable. For control of unwanted

vegetation, such as woody species, see "Herbicide Manual for Noncropland Weeds" (app. A, no. 11). For rodent control see "Military Entomology Operational Handbook" (app. A, no. 10).

15-12. Reclamation of Drastically Disturbed Areas

15-12.1. Sanitary Landfills.

15-12.1.1. *General.* Sanitary landfills on military installations require a final 2-foot minimum soil cover; a final grade which assures positive drainage and which, insofar as possible, blends with those of adjacent areas; and a vegetative cover, as directed by the grounds maintenance supervisor (AR 420-47/DA PAM 420-47; AFP 91-8; and NAVFAC MO-213/TM 5-634/AFM 91-11/NAVFAC Specifications TS-01501 (app. A, no. 18)). Sanitary landfills recognized herein are those which have been completed (i.e., where final cover of relatively impermeable material, including final grading, and some type of vegetative cover have been established). (See fig. 15-6.)



Figure 15-6. Sanitary landfill with topsoil replaced and revegetated as fill is completed.

15-12. 1.2. *Maintenance.* Properly established grades should be maintained to assure positive drainage. The vegetative cover provided, as sections and trenches of the fill have been completed, should be maintained as necessary to provide a complete soil stabilization cover. The vegetative cover may be altered to meet the designated use criteria.

15-12.1.21. See paragraph 15-12.2.5. for possible methods of improving the soil cover when the designated land use is for improved or semi-improved grounds.

15-12.1.2.2. Consideration should be given to including landfill areas in the installation wildlife requires a more

management or forest management programs. Vegetation (e.g., wildlife food and cover plants and reforestation) suitable to the planned land use should be established and maintained. Experience with wildlife food and cover plantings and reforestation has proven successful. Such planting proposals should be coordinated with local representatives of the State forest and wildlife agencies and the Soil Conservation Service.

15-12.1.2.3. If agricultural crops are to be grown, cultural operations (plowing, planting, cultivating, etc.) should comply with recommendations of the Soil Conservation Service. That agency can advise on the possible need for conducting field operations on the contour or for stripcropping and terracing.

15-12.1.2.4. Drainage control facilities designed and constructed to prevent excess surface water from flowing across the landfill area should be adequately maintained.

15-12.1.2.5. Adequate drainage structures (e.g., diversion terraces or open ditches) should be provided for those landfill areas closed in past years where a drainage problem is creating infiltration into the landfill.

15-12.2. Land Reclamation.

15-12.2.1. *General.* The reclamation of drastically disturbed areas includes all facets of heavy construction which involve cut or fill of original grade (e.g., the building of dams, power structures, roads, transmission lines, industrial and military installations, and airfields; strip mining operations; borrow and spoil areas). In some instances, when land is disturbed and the substrata exposed, the minerals exposed to the air will form highly toxic chemical reactions, polluting the rainwater which flows over them and ultimately the streams, ponds, and rivers. Spoil banks and the steep cuts from which spoils are taken scar the earth's surface and make healing after construction difficult. Soil erosion from cuts and fills contributes large quantities of silt to fields and streams into which storm water drains. Borrow areas become a source of pollution from uncontrolled runoff of surface water. The main objective of any land reclamation is to restore the land to a stable, useful state and prevent environmental damage. An effective reclamation program to accomplish this result should be formulated and completed. Slopes must be stabilized by engineering techniques prior to establishing plant material.

15-12.2.1.1. *Determination of toxic materials.* Before any construction takes place, one of the first steps is to determine the actual makeup of the overburden. Core drilling, which is done for any major construction project,

is the most reliable method for collecting soil samples. The samples should be analyzed not only for the normal purposes of construction, but also for determining the acidity or pH of each stratum of overburden. In this way, very acid soils (5.0 and below) can be located. These soils may then be treated separately.

15-12.2.1.2. *Control of toxic materials.* Various techniques have been developed for the control of toxic materials from disturbed land. Some of these techniques include: contour and terracing operations; diversion of water on the surface around disturbed areas; and revegetation with grasses, legumes, trees, shrubs, and vines. The establishment of a vegetative cover on highly acid soils is difficult and usually results in a low survival rate for planted vegetation. Thus, erosion can begin, and the resulting runoff pollutes the lowlands and adjacent water bodies. The low survival rate of the vegetation is due to the high acidity of the soil and to the low moisture retention rate in most construction areas. The upper layer (root zone) of the overburden can be treated with slag, limestone, or fly ash. The use of fly ash for the control of toxic materials is still relatively new. In order to make it economical, there must be a plentiful supply close to the project area. In addition, the material should have a high neutralization capacity. The above treatments should accomplish the following:

15-12.2.1.2.1. Raise the pH of the soil to a level which will promote the growth of plants and legumes.

15-12.2.1.2.2. Increase the moisture retention of the soil.

15-12.2.1.2.3. Permit the establishment of stable vegetative cover which will reduce the movement of water and oxygen to the pyritic material in the soil, thus reducing production of acid soil material.

15-12.2.1.3. *Depth of cover.* Since most drastically disturbed areas have a compacted soil seriously lacking in nutrients, it is necessary either to improve the soil material or to place new fill of more friable soil on top. The depth of cover should vary with the type of subsurface. If the subsurface is rock, then the overburden fill should be a minimum of 2 feet with a minimum of 6 inches of topsoil. If the subsurface can be loosened to a depth of 6 to 12 inches, then the amount of fill may be reduced to a minimum of 12 inches with 6 inches of topsoil. To improve a subsoil sufficiently to support vegetation requires a more lengthy process, as

described in paragraph 15-12.2.5.

15-12.2.1.4. Control of waterflow. Excessive runoff and erosion are among the most serious adverse effects of drastically disturbed areas, and their control are major reclamation objectives. Sedimentation may contribute to increased flood damage downstream by reducing channel capacities. Erosion in relatively flat areas, where little soil can actually leave the area, is detrimental only when it is severe enough to hinder or prevent revegetation.

15-12.2.1.4.1. Stream siltation is one of the most important off-site factors causing land disruption. Silt basins constructed in the valleys, below and above disturbed areas, offer some control by catching and holding much eroded material before it reaches a project or main bodies of water.

15-12.2.1.4.2. Proper grading and drainage should be an essential part of project control measures. Much erosion and subsequent sedimentation can be eliminated by controlling storm runoff. When storm runoff is held in a pit or pond, most of the sediment will be trapped. Terraces can be used to accomplish the same thing. They can also be important for vegetation establishment and growth. Other mechanical measures for initial erosion control on freshly graded areas are contouring and ditching, performed in conjunction with seedbed preparation.

15-12.2.1.4.3. A chemical binder or tack is a latex emulsion, plastic film, resin-in-water emulsion, or similar product, usually sprayed on bare soils or mulches, to bind soil particles or mulch material and reduce soil moisture loss. A chemical binder or tack may be used on any disturbed area which is being reclaimed. If reclamation is being performed at a time when seeding cannot be done (i.e., summer, late fall, or winter), chemical binders may be used to temporarily stabilize the soil until seeding can be performed. Chemical binders are also used extensively in arid regions and on droughty soils because of their effectiveness in retaining soil moisture. Many products are available for use as temporary soil stabilizers, mulches, or mulch tacks. Selection of any product should be based on the following criteria: intended use, effectiveness, cost (including labor and any special equipment required for application), availability, and a field test when possible. Specific inquiries regarding application rates or product limitations should be addressed to the manufacturers.

15-12.2.1.4.4. Establishment of vegetation on disturbed areas is usually the final step in land reclamation. The place to start control of runoff and erosion is at the source of the problem on the disturbed area. Perennial grasses and legumes have a remarkable ability to

reduce runoff and prevent erosion once they are established. A quick-growing cover of herbaceous species will provide temporary cover essential for initial protection against erosion. More permanent covers should be seeded or planted on those areas where additional protection is needed for long periods. Getting a vegetative cover on spoil areas as soon as possible may also prevent acid production and seepage.

15-12.2.1.4.5. All areas where major construction will take place should, as a first priority, be thoroughly studied to determine whether the construction will affect any streams, ponds, lakes, or rivers within the watershed. Surface drainage from the area to be disturbed must be controlled before construction begins. If the disturbed area is on a slope, diversion ditches and safe outlets should be constructed to keep surface water from the site. Sediment control structures should be installed to form basins above each stream which may be affected by runoff. Water should not be released from these basins until all sediment has settled out, and the amount of suspended matter is minimal. The water must be neither too acidic (under pH 5.0) nor too alkaline (over pH 9.0), nor must it contain more than 7 milligrams of iron per liter. Sediment structures should be maintained for the life of a construction project and until vegetative cover is established.

15-12.2.1.4.6. Construction activities should be kept as far away from streams and other water bodies as possible. Projects which are, of necessity, located on or adjacent to natural water courses must provide and maintain extensive erosion and sediment control structures.

15-12.2.1.4.7. Dumping spoil, refuse, trash, etc., should not be permitted in areas outside the project limits-of-work, except in emergencies and then, only in areas previously designated as dump areas and coordinated, as may be necessary, with local and State authorities. Plans for the reclamation and beautification of offsite dump areas should be prepared and carried out as part of the project work.

15-12.2.1.4.8. Damage by equipment is not necessarily limited to actual construction sites but may occur in areas which were intended to be preserved or protected and in areas which are adjacent to, but not part of, the project. Such damage is often done by bulldozing equipment or trucks seeking the shortest distance to

their destination. Any destruction should be repaired as soon as possible by filling in, seeding, and mulching. Reclamation of heavy construction areas poses the problems of providing adequate drainage and improving the soil for support of vegetation. Steep slopes may require intercepting drainage ditches to slow the movement of surface water until newly planted vegetation has developed sufficiently to control erosion. Methods of improving the soil for vegetation are described in paragraphs 15-12.2.1.3. and 15-12.2.5.

15-12.2.2. Roadways (haul and access roads). All construction projects require both temporary and permanent haul and access roads. Temporary haul and access roads should be obliterated as soon as they are no longer needed, regraded to natural contours with proper drainage, and revegetated. Permanent access and service roads should be carefully designed and constructed for soil erosion control and safe surface water disposal. AU permanent roads should be hard-surfaced. Roadside slopes (cut and fill) should have a maximum 2:1 slope or, preferably, a 3:1 or 4:1 slope with rounded transitional profiles at top and bottom. They should be planted and mulched as soon after grading as possible with native grasses, ground covers, shrubs, and trees as may be appropriate. Roadside ditches on steep areas should be paved with rock, asphalt, or concrete to prevent undercutting of the slope or roadway. Ditches with moderate to shallow grades may be seeded to native grasses. Sod should be used around catch basins as an added protection against siltation until the grass becomes established in the ditches and on the slopes.

15-12.2.3. Surface alteration.

15-12.2.3.1. Borrow areas. Major construction often requires that large areas of land be used for borrow pits and storage yards. These areas may average 50 to 300 acres in size and 10 to 50 feet in depth, depending upon the depth of the subsoil. Usually, the topsoil is stripped from the area as an initial operation and stored for future backfill over the graded areas. However, in many instances, the depth of topsoil is either nonexistent or too shallow to make it economical to stockpile. Under such conditions, the remaining subsoil must be improved to support vegetation. Methods have been developed which, within a few short years, support trees, shrubs, and vegetation for cattle grazing. MCGS 02821, MCGS 02831, TM 5-830-2 and TM 5-830-4, (app. A) provide guidelines for establishment of vegetation.

15-12.2.3.2. Spoil areas. Spoil areas are usually made up of all types of materials: soil, shale, and rock. To reclaim such areas, a process similar to that described for borrow areas may be used. However, if the spoil is

mostly rock, a layer of overburden approximately 18 inches thick should be placed and graded smooth. If the overburden is a combination of topsoil and clay, establishing vegetation becomes simpler; then, the normal procedure of preparing a seedbed, fertilizing, and seeding can be used.

15-12.2.3.3. Abandoned construction sites. All abandoned construction sites should be regarded to correct drainage problems, to provide a smooth and pleasing terrain, and to provide a good planting base. Debris and old, worn-out equipment should be removed from the site. The area, if graded for a lawn, should be topsoiled to a depth of 4 to 6 inches, provided the subsoil is satisfactory, and seeded to grasses suitable to the area and climate. A landscape planting plan for woody plants may be prepared where appropriate. If the subsoil is unsatisfactory, see paragraph 15-12.2.5. for corrective action.

15-12.2.3.4. Building demolition areas. Wherever buildings are torn down, the debris should be hauled away, buried in an approved area, or burned, if legally permissible. All basements and old foundations should be filled in, and the area graded to match the existing land in the vicinity. Drainage problems should be corrected so that the area drains properly and does not create a pollution problem. Finally, the area should be topsoiled with a minimum of 4 inches of soil for grass and a minimum of 12 inches for landscape planting beds/zones. Soil tests should be made, and the area fertilized and limed as appropriate for a grass mixture recommended for the local area. Planting of trees and shrubs should be done in accordance with a landscape planting plan.

15-12.2.3.5. Sand and gravel pits. Sand and gravel pits usually lack the nutrients necessary to support vegetation. To reclaim them to a grass mixture cover, the first step is to regrade the area to eliminate water pockets, smooth out steep slopes, and generally produce a smooth, undulating, but well drained terrain. Secondly, the area should be covered with a minimum of 18 inches of overburden with sufficient humus and water retention capabilities to sustain vegetation. Then, the area should be limed and fertilized according to a soil test, chemicals worked into the top 4 to 6 inches, and an approved grass seed mixture for the particular area

applied. Following the seeding, mulch with 1 1/2 to 2 tons of hay or straw per acre. The mulch should be suitably tacked down. (See para. 15-12.2.1.4.3.) If the area is to be utilized for wildlife food and cover or for reforestation, such plantings can be made without adding overburden material. In such situations, recommendations as to species to plant and the possibility of adding soil amendments (lime, fertilizer, etc.) should be obtained from the Soil Conservation Service.

15-12.2.3.6. Rock quarries. Abandoned rock quarries can pose a difficult problem. If the quarry becomes a deep pit, with no natural outlet, the simplest solution is to let it fill with water. Usually, a rock quarry has one or more springs which have been opened up during the course of the excavation, and these springs should be enough to maintain a clean body of water. In many cases, especially if the quarry has no source of water, the upper rim should be completely fenced in order to keep out people and animals. Quarries with one or more open sides may be screened to some extent by planting native trees and shrubs at the base of the quarry wall. In order to do this, the quarry floor should be graded to drain. Any excess overburden left on the quarry floor should be pushed up against the high walls to form a mound on which trees and shrubs may be planted. A more naturalistic form may be attained by placing additional overburden on the quarry floor in mounds of various shapes and planting native trees and shrubs thereon. Planting the outer edge of the quarry with trees and shrubs can provide a complete screening effect.

15-12.2.4. Diversion terraces. Water is wasted and erosion results when long slopes of bare earth are exposed to the forces of falling rain and subsequent overland flow. Diversion terraces, long an effective means of controlling surface runoff and soil erosion on agricultural land, also are useful in checking runoff and erosion, and conserving moisture on drastically disturbed areas. Design criteria for construction of diversions and terraces can be found in Standards and Specifications for Soil Erosion and Sediment Control (app. E, no. 8).

15-12.2.5. Subsoil improvement. Wherever topsoil is not available, but the subsoil is deep enough to be worked, it is possible to institute an improvement program. With the treatment described below, most subsoils will support a permanent grass cover within 2 or 3 years, provided an annual maintenance program is maintained.

15-12.2.5.1. Scarify as deeply as possible (preferably to a depth of 12 to 18 inches, depending upon the terrain, type of soil, and site location).

15-12.2.5.2. Incorporate a 4-inch depth of hay or straw

throughout the scarified area. Other soil improvement materials, such as sawdust, may be used. If fresh sawdust is used, a form of nitrogen should be added to assist in decomposing the sawdust.

15-12.2.5.3. After the additives have been thoroughly worked into the soil, prepare a smooth seedbed and fertilize and lime, using amounts determined by a soil test.

15-12.2.5.4. Seed a cover crop of legumes and rough grasses, using varieties recommended for the area. Covers such as soybeans, crimson clover, Yucchi clover, Korean lespedeza, and vetch are good soil builders.

15-12.2.5.5. Let the cover crop mature and plow it back into the soil in the fall. Make a soil test, refertilize accordingly, and seed to a winter crop such as winter rye or wheat.

15-12.2.5.6. Plow the winter crop back into the soil in the spring, make a soil test, refertilize accordingly, till and provide finish grade as may be desired for the appropriate planned vegetation.

15-12.2.5.7. Portions of the area may be revegetated with trees and shrubs suitable to the area and without finish grade.

15-12.2.6. For finish grading, topsoiling, soil tests, seedbed preparation, and establishing vegetation (seeding grasses and legumes, sodding, fertilizing, and mulching), see paragraph 15-5.

15-12.2.7. Planting with trees, shrubs, ground covers, and vines. When all construction is completed, and the disturbed areas cleaned up, regraded, properly drained, and revegetated with grasses and legumes, the area may be permanently planted with trees, shrubs, ground covers, and vines in accordance with a landscape planting plan (annex I to app. C). Planting guidelines are provided in paragraph 15.6.

15-12.3. Land Use After Reclamation

15-12.3.1. Water impoundments. Wherever water is available, and topography permits, impoundments should be encouraged. Impoundments make excellent recreational sites as well as water storage sites for industrial and agricultural uses. Ponds and other impoundments can be used for flood control improvement of ground water levels, forest fire control and fish and wildlife. Fingerlings for stocking can be obtained from Federal, State, or private organizations.

15-12.3.2. *Wildlife habitat.* Wildlife will often do better on recently reclaimed land than in mature forests where the overhead canopy retards the growth of wildlife forage. State and private organizations may supply game birds and other wildlife to stock such an area if necessary. (Natural Resources-Fish and Wildlife Management (app. A, no. 4).)

15-12.3.3. *Recreation sites.* Many reclaimed sites can be used for recreation areas for hiking, horse back riding, camping, and fishing, among other activities. Golf courses may also be developed on reclaimed land.

15-12.3.4. *Homesites.* Properly reclaimed land can be used as lots for homes and trailer parks.

15-12.3.5. *Agriculture and pastureland.* Reclaimed land may be used for agricultural crops and as feedlots for cattle. It also can provide good pasture if restoration has been carried out properly.

15-12.3.6. *Commercial forests.* Reclaimed land can grow commercially profitable crops of pine pulpwood and other timber crops.

15-13. Mowing.

15-13.1. Height of Mowing.

15-13.1.1. Lawns, cemeteries, physical training areas (ball diamonds, football fields), parade grounds, and similar areas of turf are mowed at a height of 2 to 3 inches. Kentucky bluegrass should be mowed no lower than 2 inches, with higher levels provided during the summer months. Mixtures of bluegrass and Bermuda, and bluegrass and bent grass, should be mowed to favor the species desired. Close cutting of such mixtures will tend to eliminate bluegrass. Exceptions to the above criterion are 3/4 to 1 inch mowing height for bent grass and some strains of Bermuda grass. Some further information on mowing height is contained in paragraph 15-5.3. Installations should coordinate mowing height for specific grasses, by areas of use, with local agricultural agencies.

15-13.1.2. Golf courses also require special consideration as they must be maintained in accordance with specified rules of play. Dense, matted or thatched turf may require an occasional cleanup by close mowing and scarification to remove excess material before reseeding and fertilization. Such operations must be planned for the proper season, to prevent an invasion by weeds.

15-13.1.3. On airfields, grass height management is a tool in reducing airfield bird population, thus reducing bird/aircraft strike hazards. In general, airfield grass height should be maintained at a height of 6 to 12 inches. Although this recommended height will vary with grasses

involved, geographic location, and location climate, 6 to 12 inches is a good standard to work from for the following reasons:

15-13.1.3.1. This height is tall enough to discourage those birds which prefer short grass areas because of the easily accessible invertebrate food supplies and good visibility.

15-13.1.3.2. It is short enough to discourage the presence of small mammals which are food for hawks and owls. Ground-nesting birds are similarly discouraged. Cutting the grass prior to maturity also reduces the attractiveness by eliminating the seeds, an important food source for many birds. 15-13.1.3.3. It is an ecologically sound practice. Close frequent mowing should not be permitted since it weakens many turf grass species and encourages weeds.

15-13.2. *Policing, Clearing, and Leveling of Mowed Areas.* Efficient operation of mowing equipment depends upon proper maintenance of areas to be mowed. Remove wire, bottles, rocks, and the like on a scheduled basis. Remove brush, stumps, and unnecessary trees and shrubs to permit the use of tractor-operated units. Level and smooth minor ridges and depressions with disk and drag harrows. Blade equipped maintainers are effective for eliminating prominent ridges or knobs. Some rough areas may require plowing, leveling, and replanting.

15-13.3. *Modifying Slopes and Planting.* Where desirable for efficient mowing, existing ground slopes and tree and shrub planting should be modified by regrading and replanting to meet planting design objectives described in paragraph 15-6.2.

15-13.4. *Mowing Frequencies.* Mow improved grounds at intervals sufficient to prevent vegetative growths from exceeding 4 inches. More frequent intervals may need to be adopted for lawns which produce unsightly seed heads, physical training areas, and golf courses. Mow clear zones of airfields and road shoulders at intervals sufficient to prevent vegetative growths from exceeding 8 inches. Unimproved grounds other than road shoulders and airfield clear zones (firebreaks, drainage channels, maneuver areas, open areas where fire protection is required) will be mowed sufficiently often to permit military use and to prevent drainage failures and rapid spread of fires. Local climatic and use requirements of such areas apply. Do not delay mowing of hazardous

areas past the onset of the expected fire season. Use herbicides in connection with mowing to reduce mowing requirements. Broadleaf weeds and brush may be more economically controlled with herbicides than by mowing. (See chap. 11 for herbicide kinds and safety precautions.)

15-13.5. Roadside and airfield mowing. Mowing of roadsides and airfields is performed to preserve erosion-resisting turf; provide marginal strips for emergency use; maintain sight distances for markers, signs, and traffic safety structures; reduce snow accumulations on adjacent pavements; accelerate drainage; reduce fire hazards; and provide an attractive appearance. For

roadways, mow strips 20 feet in width from the pavement edges along the principal traffic arteries and 15 feet along other paved roadways. Where embankments or ditch slopes steeper than 3 to 1 impinge upon these 20- or 15-foot strips, mow a single cutterbar width up or down the embankment where feasible. Requirements for mowing other than paved roadsides will be determined by evaluation of local conditions and road use. Prevention of drainage failures and soil erosion, and use of rights-of-way for firebreaks are of principal interest. For airfields, mow clear and approach zones and other graded and maintained areas.

CHAPTER 16. IRRIGATION

16-1. Introduction.

16-1.1. *Function.* Irrigation is desirable on many installations to supplement natural rainfall in the maintenance of healthy vegetative growth. Before any irrigation project is undertaken, a schedule of priorities should be developed which takes into consideration the possible consequences of no irrigation or, in the case of existing systems, the loss of irrigation capability. Permanent consequences such as loss of turf and landscape plantings should be weighed heavily in formulation of these priority schedules.

16-1.2. *Factors Affecting Irrigation.* Where irrigation is necessary, the following factors are of major importance and should be considered:

16-1.2.1. The availability of existing water supplies and the feasibility of their use.

16-1.2.2. The amount of water required, depending upon the type of plants or turf to be irrigated (either existing or proposed), climate, terrain, and soil conditions.

16-1.2.3. The amount of money allocated to a project

(this determines the extent to which irrigation can be achieved).

16-1.3. *Irrigation Areas.* All equipment and system components should be selected with regard to maximum service and flexibility consistent with cost. Where there is a recognizable need for frequent water application in a fixed location, consideration should be given to permanent systems with automatic control capability. Areas such as athletic fields, parade grounds, and training and administrative areas may require irrigation to maintain vigorous turf growth. Golf courses nearly always require some form of irrigation because of their heavy use and the special turf required for greens, tees, and, in some cases, fairways. Due to the permanent nature of golf courses and their high irrigation frequency, every effort should be made to insure that their irrigation systems are as automatic and maintenance-free as possible (fig. 16-1).



Figure 16-1. A permanent irrigation system in operation.

16-1.4. Design Services. Irrigation is rapidly becoming more sophisticated as the cost of manpower and the availability of reliable irrigation systems increase. Almost all projects require assistance from irrigation experts and associated technologists. A person familiar with the moisture requirements of the plant species to be irrigated and the local rainfall patterns should be consulted to ascertain the optimal amount and frequency of irrigation required. Irrigation experts include agronomists, landscape architects, irrigation specialists, agricultural agents, and members of university agronomy departments. These professionals can evaluate such additional factors as soil types, slopes, and runoff as well as the quality of water proposed for irrigation use. The installation health and environment section is a valuable resource for assistance in determining the characteristics and acceptability of nonpotable sources. Engineers or

irrigation technicians familiar with hydraulic design are normally required for the most effective design of irrigation systems.

16-2. Water Source Alternatives.

16-2.1. Source Considerations. Once it has been determined that irrigation is needed, the sources of irrigation water should be closely examined to insure dependability under adverse conditions when irrigation will be most necessary. Any source, no matter how seemingly practical or inexpensive, does not merit consideration as a sole source of supply if it is not dependable. Where two or more dependable sources of water are available, each of the sources should be cost-estimated on the basis of first cost, maintenance cost, operation cost, and the cost of water, if any, to determine which alternative is most feasible.

16-2.1.1. Potable water systems. Where the use of a potable water source seems most feasible, the designer should research the existing water supply system capabilities. Connecting into existing water mains, even large mains, may not be feasible. The designer must insure that the proposed tie-in point to an existing water system will furnish sufficient flow at adequate pressures to supply both the existing and proposed domestic, industrial, and fire-flow requirements as well as the proposed irrigation requirement. The use of potable water must not interfere with the normal domestic requirements. There are numerous techniques for satisfying these requirements, such as multiple tie-in points to the existing water distribution system or enlargement of water main sizes leading to the tie-in point. Whether the water supply for an installation is from an adjacent utility or totally self-contained, major changes in usage rates should be brought to the attention of the operating agency for approval. Scar-city of water, limitations in treatment capacity, or the high cost of water could make an alternate non-potable source necessary or desirable.

16-2.1.2. Nonpotable water systems. The use of nonpotable water sources for irrigation may be desirable when the water quality meets all applicable health regulations for its intended use. Various sources of nonpotable water include treated effluent, reservoirs, streams, treated industrial-process water, coolant water, and well water. Alternative irrigation water sources must be reliable, especially during the maximum anticipated period of drought. The Geological Survey (app. D, no. 8) is the foremost source of stream-flow and groundwater data in the United States and can usually furnish statistical data for low flows and water quality on the principal streams within each State. The Survey also has subsurface maps and groundwater data which are useful in estimating probable well capacities and depths in most localities.

16-2.1.2.1. Where reservoir water sources are under consideration, all available information should be studied to verify that maximum irrigation demands can be satisfied. The stage storage curve, a plot of pool elevation versus available volume, should be compared to seasonal pool elevation records to determine at what elevation the intake must be located to provide an adequate water supply.

16-2.1.2.2. Where well water sources are indicated for use and available yields are uncertain, a test well and piezometers should be sunk and a pumping test performed to determine the size, depth, and spacing of the well or wells required. Any substantial depression of the water table due to pumping should be investigated to determine the effect on other wells using the same

aquifer.

16-2.1.2.3. In most cases, primary and secondary wastewater treatment produces a disinfected, relatively clear effluent suitable for irrigation. There are several advantages to using the effluent: water is conserved; nutrients are supplied to the soil; the cost of sewage treatment and disposal may be reduced; and the turf provides a form of tertiary treatment as the effluent filters through the soil. There are, however, many instances not suited to effluent use including, certain types of ornamental plants have a low tolerance for salt and boron found in effluent water; certain soils may not allow the effluent to be filtered, thereby polluting surface water and groundwater; and irrigation lines, pumps, and storage facilities may cost more because of the need to filter, chlorinate, and contain a more corrosive substance. If domestic water supplies are expensive, the additional cost may be worthwhile. Before a decision is made to use sewage treatment effluent, a careful study should be made to analyze the effects of its use. See appendix A, No. 19, for guidance regarding the use of effluent for irrigation.

16-2.2. Water Availability. When the installation's potable water system is to be used for irrigation, both its source and distribution system should be investigated to insure that the required quantity of irrigation water is available for the project. Where stream waters are to be used, the flow should be verified for low-flow periods, and intake structure elevations should be determined so that required quantities may be obtained even when the stream-surface elevation is below normal levels. The installation's legal staff should verify that the use of the full design quantity is possible without violating riparian rights of downstream property owners and water rights involving underground supplies. A preliminary estimate of the required water supply for new irrigation projects should be made. Similar projects which are currently in use on the installation may provide helpful guidance on water-use quantities. Where there is no basis for estimation, the recommendations of local consultants should be obtained. The preliminary estimate will aid installation planners in foreseeing most negative effects of a proposed irrigation project or improvement before significant amounts of time and money are expended. Such studies for areas where irrigation is definitely required are helpful in identifying improvements that must be made in existing water systems to serve the proposed irrigation projects. Where sources of irrigation

water other than potable water systems are desirable, the preliminary estimate will assist the designer in determining whether or not alternate sources are capable of supplying the required demand.

16-2.3. Water Conservation. With more and more emphasis being placed on conserving natural resources, intelligent use of water supplies becomes increasingly important. Properly designed sprinkler systems can result in significant water savings, compared to hand watering. Because large quantities of water are used in irrigation, it is necessary that systems be designed to eliminate waste. Pipelines and sprinklers must be sized and located to supply only the amount of water needed to meet the irrigation demand. The system should be operated only when necessary and should not provide more water than the soil can absorb. The use of drought-resistant plantings and turf can also reduce the amount of water necessary for irrigation. In addition, a relatively new design for greens on golf courses is becoming an important method of water conservation. This system consists of placing an impermeable plastic membrane at an appropriate depth below the surface of the greens. The membrane prevents water from filtering through the soil thus creating a constant moisture level in the green. Since the green is constructed of sand, the water is drawn toward the surface by capillary action. The ability to store the water in the soil reduces the demand for irrigation. Although the method can be adapted for use in any location, the availability of sand must be considered. These methods, as well as the reuse of sewage treatment effluent discussed in paragraph 16-2.1.2., will aid in water conservation.

16-3. Determination of Irrigation Requirements.

16-3.1. Vegetation Characteristics. To properly design an irrigation system, the designer should closely examine the water requirements of the existing and proposed vegetation. The plant water requirement includes the amount of water lost to evapotranspiration plus the water required by the plant. The evapotranspiration rate is the combined loss of water from the soil due to evaporation and transpiration from the plant's leaves. The rate is significant during periods of low rainfall in areas where low humidity and windy conditions prevail, and it should be considered in estimating the actual amount of moisture the vegetation is likely to receive due to rainfall. The amount of water to be added to the vegetation consists of the evapotranspiration rate plus the water required to maintain a given level of moisture in the soil. This water requirement should then be compared with the amount of water that can be retained by the soil during the same period of time in order to determine the proper irrigation rate to be used without causing runoff.

16-3.2. Physiography. The nature of the land must also be evaluated to determine its effect on irrigation.

16-3.2.1. Soils. Identification of soil types is important in determining the duration and frequency of watering. It is also important to take into account the wide variation in soil absorption capabilities, both when designing the system and when determining watering schedules. Table 16-1 categorizes different types of soil, intake rates, and retention rates which can be helpful. For information relating to soil Surveys and land use capabilities, see chapter 5.

Table 16-1. Water Holding Capabilities and Infiltration Rates for Various Soil Textures. a

Soil classes	Water retention in/ft	Intake rate in/hr	Application rate ^b		
			0-5% Slope in/hr	5-10% Slope in/hr	Over 10% Slope in/hr
Coarse-texture sands and loamy sands	0.5-1.0	1.00-0.50	0.80-0.40	0.60-0.30	0.40-0.20
Coarse to fine sandy loams	1.0-1.5	0.75-0.35	0.60-0.30	0.45-0.22	0.30-0.15
Very fine sandy loams, loams, sandy clay, and silt loams	1.5-2.5	0.40-0.25	0.35-0.20	0.30-0.15	0.20-0.12
Clay loams and silty clay loams	1.5-2.5	0.30-0.20	0.25-0.20	0.20-0.12	0.15-0.10
Sandy clay, silt clay, and clay	1.5-2.5	0.15-0.05	0.15	0.10	0.10

^a Adapted from Sprinkler Irrigation Manual, Johns-Manville, General Sprinkler Corporation, Fresno, California.

^b Infiltration rates are for bare ground. Rates can be increased with good vegetative cover.

16-3.2.2. Site features. At the time a subsurface soil examination is made, any pertinent characteristics of the site should be noted if they will have a bearing on the irrigation system. Features such as steep slopes, erosion problems, and high water tables are of concern. Unless the soil is extremely porous, water applied to steeply inclined areas will tend to run off if applied at rates that may be acceptable on lesser slopes. To achieve a uniform irrigation application, the system designer must account for these factors.

16-3.3. Climate. Records of local weather patterns are helpful in quantifying irrigation needs. A local climatological data pamphlet is available for nearly every area of the United States from the National Climatic Center (app. D, no. 9). The actual growing-season moisture requirements of planting under consideration for irrigation should be carefully evaluated and compared with minimum anticipated rainfall to insure that irrigation is really necessary. Warm to hot climates require more water for irrigation. Cooler climates require less water and, perhaps, less frequent irrigation. Adverse wind conditions also influence the irrigation requirement. High winds tend to dry out irrigated areas, thus requiring more water to be added.

16-4. Distribution Selection Alternatives.

16-4.1. Irrigation System Alternatives. Where irrigation is necessary, the following methods of application should be investigated to determine which is best for the facility.

16-4.1.1. Permanent sprinkler systems. Permanent sprinkler systems are of two basic types: pop-up and quick-coupling. Pop-up heads are suitable for irrigation of small areas, irregular border areas, and large irrigation areas. Pop-up sprinkler heads are positioned flush with the ground surface and extend above grade when the water is turned on at the controlling valve. They require little attention during the irrigation season except that, in some cases, vegetation around the head must be periodically trimmed to prevent interference with the spray patterns. The quick-coupling systems are generally used where installation funds are limited, or there is a readily available labor force to move the sprinkler heads. Quick-coupling heads are manually placed for each irrigation by connecting them into subsurface socket. Quick-coupling heads do pose a problem for lawn mowers and must be removed before mowing. Another factor to be considered is the intensity of the winds. A single large head may typically provide less uniform coverage than several smaller heads on windy days. See appendix A, No. 19, for guidance on underground systems.

16-4.1.2. Portable sprinkler systems. Where the

frequency of irrigation does not justify the installation of permanently installed irrigation systems, or where irrigation is necessary only during the period of establishing new vegetation, portable systems may provide a suitable alternative. The type of water source needed for these systems varies since they may be used with hydrant connections or with portable pump systems from lakes, streams, or canals. The method of application from the portable supply mains is also flexible since they may be used to saturate a relatively flat area by either open-end discharge or perforated sections, or they may be used in conjunction with attached sprinkler or octopus hose and sprinkler systems. These systems are generally labor-intensive and may not be as closely matched to the irrigation needs of each area as a well designed permanent system. Above-ground pipes are unattractive in landscaped areas and obstruct grounds maintenance operations. System layouts vary depending upon local conditions and available equipment.

16-4.1.3. Subsurface irrigation systems. Drip tube systems may be desirable for trees and shrubs. These systems are generally composed of several very small, weighted waterlines spaced throughout the root zone. They may be used either with manual control or with automatic control by time clocks or moisture sensors.

16-4.2. Selection Considerations. Once irrigation requirements have been quantified, the actual method of distribution and application may be selected and evaluated. Site conditions should be carefully considered to determine the type or types of irrigation best suited to the installation. Local irrigation practice will often provide an indication of which systems are the most feasible in a particular area. It is good practice and beneficial to community relations to provide systems for irrigation which are not considered wasteful in the area in which the installation is located. Once a system is operational its use and management should reflect good husbandry of water resources.

16-4.2.1. Codes and regulations. Any irrigation system installed as an addition to a potable water system must comply with the National Plumbing Code and public health regulations concerning back-flow prevention devices and system materials. See appendix A, no. 21, for guidance.

16-4.2.2. Long-range suitability. Utilization and utility of an irrigation system will vary widely as a direct result of

an irrigation system will vary widely as a direct result of climatological conditions and turf usage. Estimates should be made to compare various systems over the projected life of a system in order to determine which is most desirable. When two or more systems are equally durable and are of approximately equal cost, preference should be given to the system which is the most aesthetically pleasing.

16-5. Distribution Design For Piped Systems.

16-5.1. Selection fo Equipment. One of the important steps in the design of a piped system is the selection of equipment. Items which make up a piped system include controllers, valves, pipe, and sprinkler heads. See appendix A, no. 21, for guidance in plumbing requirements.

16-5.1.1. Controllers. Due to skyrocketing costs of water and labor, nonavailability of reliable personnel for odd hours, and tight maintenance budgets, automatic systems have become increasingly popular. Once the decision has been made to use automatic controls, the first step is to choose a controller to fit the system. Controllers are now available in many sizes and can control any number of circuits. Many different watering schedules can be programmed into controllers including: placing watering stations on different programs on the same or different days; using the controller in conjunction with a rain gauge to determine if irrigation is warranted and then ordering limited or skipped irrigation; and allowing manual operation at any time. A possible disadvantage of automatic controls is the high initial cost. Each situation is different, but in most cases, the cost is quickly amortized due to savings in labor and maintenance.

16-5.1.2. Values. Many different valves are necessary for safe and efficient operation of a system. It is important that the valves and connections be compatible with the pipe material to prevent bi-metal corrosion.

16-5.1.2.1. Drain values. These valves are either manually or automatically operated. They are installed in the low points of pipelines so that a system can be drained during freezing weather or repairs.

16-5.1.2.2. Pressure relief values. These valves are necessary on some systems to protect the piping if large pressures are anticipated.

16-5.1.2.3. Control values. Manually controlled systems require angle-type valves. If the system is operated by an automatic controller, automatic valves must be used. They may be either electrically or hydraulically operated and are connected directly to the controller with electrical

wires or hydraulic tubing.

16-5.1.24. Backflow prevention values. These valves are required at all cross-connections between a sprinkler system and a potable water supply. There are many different types of backflow preventers available, and the selection should be based on the type of water source, code requirements, type of sprinkler system, and type of terrain.

16-5.1.3. Pipe. It is important in terms of cost and reliability to select the proper type of pipe to fit an irrigation system. The following factors must be considered in making the selection: the flow characteristics of the system, the strength and life expectancy of the pipe, the type of soil, the cost of pipe and installation, the type of support, and trenching requirements. There are many types of pipe available for use, and there are advantages and disadvantages for each.

16-5.1.3.1. Asbestos cement pipe. This pipe is a common material for use in larger pipe sizes. It is available in various pressure ratings and has excellent flow characteristics.

16-5.1.3.2. Cast iron pipe. This pipe is very heavy in weight; therefore, it is very difficult to install. It has high strength but is expensive and susceptible to corrosion.

16-5.1.3.3. Galvanized steel pipe. This type was used for many years but because of its cost and corrosiveness, has reduced usage today.

16-5.1.3.4. Copper pipe and tubing. This type overcomes many of the objections to galvanized pipe. It has a high initial cost but a low installation cost.

16-5.1.3.5. Polyethylene plastic pipe. This pipe is made of a flexible material and is relatively inexpensive. It is generally not recommended for use due to frequent failures which may occur under pressure.

16-5.1.3.6. Poly-vinyl-chloride (PVC) pipe. This type of pipe is the most commonly used for irrigation today. It is available in various pressure ratings and in many diameters. It has a high impact strength and is inexpensive to install. PVC pipe is generally found with solvent weld, ring, or threaded joints.

16-5.1.4. Sprinklers. To accomplish the desired result, the proper sprinkler must be selected. The designed must take into account the type of sprinkler desired (either pop-up or stationary), size and shape of the area

to be irrigated, type of vegetation, available water supply, climate, and soil conditions. Basically, there are three types of sprinklers available for use: spray head, impact, and gear-driven sprinklers.

16-5.1.4.1. Spray head sprinklers. This type generally emits water in sheets. They operate well with low pressures within a range of 15 to 30 psi and cover small areas from 20 to 40 feet in diameter. These sprinklers apply water at a relatively high rate, from 1 to 2 inches per hour. They generally are used to water flower and shrub beds and small lawn areas.

16-5.1.4.2. Impact and gear-driven sprinklers. This type of sprinkler is installed either on permanent risers above the ground or on swing-joint risers submerged to ground level. Impact sprinklers are sometimes used with quick-coupling valves. They emit streams of water, rotating over an area 50 to 200 feet in diameter, and they apply water at a rather low rate, typically 1/4 to 1/2 inch per hour. They generally operate at higher pressures (from 30 to 80 psi). They are used mostly for large, open turf areas, such as golf courses, where the number of sprinkler heads and fittings can be reduced. On sites where part-circle sprinkler heads are used, they must be valved and timed separately from full-circle sprinkler heads.

16-5.2. Layout Design. The following information should be helpful in locating mainline and lateral circuits and sprinkler heads.

16-5.2.1. Mainline pipe should be located in areas where installation and maintenance can occur with minimum interruption to the landscape.

16-5.2.2. The lateral circuits should be arranged so that pressure losses are kept to a minimum. It is important to keep in mind the location of mainlines and all necessary valves when routing these circuits.

16-5.2.3. When locating sprinkler heads, it is important that all areas which require sprinkling be covered, and that spray be directed away from buildings and streets. Since all sprinklers are different, it is recommended that the designer consult with sprinkler suppliers to insure that the correct sprinklers are selected, and that they are located properly.

16-6. System Operation.

16-6.1. Installation. Of equal importance with the design of an irrigation system is the accuracy of its installation. Regardless of the quality of a design, a system that is installed with improper construction practices is practically worthless. Care must be taken to insure that the installation is completed according to plans and specifications. After completion, construction and as-built plans of all permanent systems should be kept on file. All pipes carrying nonpotable water should be identified in

the field and on the plans to prevent accidental cross-connections. All valve locations should be shown on the plans and should be referenced to three permanent landmarks wherever possible. If the installation has plumbing shop valve books, this information should be included in them.

16-6.2. Operating Procedures. The responsibility for operation, scheduling, and inspection of the system should be clearly defined. Optimal performance of an irrigation system is attainable usually only by skilled operators due to the widely varying irrigation requirements experienced over a typical irrigation season. The knowledge gained in operating the system should be combined with the instructions of the designer to formulate a set of standard operating procedures for the system. These procedures, together with a copy of the as-built plans, should be made available to the individuals responsible for operations. The criteria for water use during emergency conditions should be predetermined with the installation commander. In some instances, the use of sprinkler systems has been incorporated into installation emergency plans for personnel and equipment decontamination showers. Final coordination should be made with all who assisted in the design to insure that the system is at optimal operation.

16-6.2.1. Field checks. Field checks of ground moisture after the sprinkling cycle are beneficial in adjusting the system. Permanent and portable irrigation testers are available through irrigation supply dealers. Field operation tests can be performed using readily available materials. Hose system output can be measured by recording the time required to fill a garbage can of known capacity. The capacity in gallons is then divided by the minutes required to fill the container in order to determine the rate in gallons per minute. Sprinklers can be measured by placing several cans in the spray pattern for an hour. After one hour, the depth collected in the can is measured, and the output is expressed as inches per hour.

16-6.2.2. Water meters. Whenever economically feasible, an irrigation system should be equipped with a metering device. The meter can be used to provide valuable information that will aid in developing an optimal irrigation schedule. It can also be used to help verify malfunctions in the system and can indicate where maintenance is necessary.

16-6.3. Maintenance. Routine maintenance should be scheduled as needed to prevent major breakdowns. Local conditions and the type of system will determine the frequency of maintenance required. Records should be kept on which components in any irrigation system experience failure. After a period of time, any trouble spots requiring remedial action should become evident to the maintenance staff. Maintenance records will also help the system manager determine how large an inventory of spare parts should be kept on hand for emergency repairs. Installation procurement personnel should be contacted to determine what procedures must be followed to insure the availability of replacement parts for the irrigation system. Items such as sprinkler heads

and valves generally require regular maintenance due to their susceptibility to clogging. For this reason, most modern equipment is designed so that replacement of these parts can be achieved with minimal effect on the operation of the system. Seasonal irrigation needs should be included as a section within the standard operating procedures. Where winter freezing is a possibility, the system should be designed so that it may be winterized to prevent damage from freezing. The operations necessary for winterizing the irrigation system should be incorporated in the standard operating procedures. Self-draining systems are permissible only when the drain sumps will provide positive, clear drainage away from the system.

CHAPTER 17.
OUTLEASES AND SERVICE
CONTRACT AREAS

17-1. Agricultural Leases. AR lands under DOD jurisdiction are not occupied for continuous military use. Lands suitable for production of crops or for livestock grazing can be managed and protected under outlease agreements (AR 405-80, AR 420-74 and DA PAM 420-7; AFR 87-3, AFR 126-1; and NAVFAC P-73). Evaluate the lands not in continuous military use and declare available that acreage which can be managed economically and at a profit to the lessee. Assistance from local, Federal or State agricultural representatives will be helpful in determining economic suitability. Outleases are appropriate provided the agricultural operations will not interfere with the military mission of the installation. Grazing and crop leases result in reduced maintenance costs when properly applied conservation practices are a part of the lease. The conservation plan (land use practices) for outleased land is, in effect, a specification of the lease which controls the lessee in his use and care of the land. Such care results in land enhancement to the military and avoids possible damage to nearby military operations. Items to be included in the plan are as follows:

17-1.1. Agricultural Lands.

17-1.1.1. Land use according to capability. See chapter 5, Soils.

17-1.1.2. Special erosion control requirements including runoff and erosion control structures (e.g., contour strips, rotations, and diversion terraces).

17-1.1.3. Drainage requirements.

17-1.1.4. The crops to be grown. (Restrict crops to those most compatible with soil properties and military land use, and to those not on the Federal Government's surplus supply list.)

17-1.1.5. Fertilizer and lime requirements.

17-1.1.6. Tillage methods.

17-1.1.7. General management practices to be employed, year by year, on each acre operated under the outlease.

17-1.1.8. Provisions for conservation and management of wildlife and protection of threatened and endangered species.

17-1.2. Grazing Lands.

17-1.2.1. Range condition and animal-unit carrying

capacity.

17-1.2.2. Seasons and dates that grazing is permitted.

17-1.2.3. Special runoff and erosion control practices required.

17-1.2.4. Fertilization, seeding, mowing, and use of herbicides if required.

17-1.2.5. Development of water supplies and control of watering practice.

17-1.2.6. Special grazing control plans for best utilization of the range.

17-1.2.7. Fire prevention practices.

17-1.2.8. Fencing requirements.

17-1.2.9. Grazing protection for woodlands.

17-1.2.10. Provisions for conservation and management of wildlife and protection of threatened and endangered species.

17-2. Maintenance Service Contracts. Service contracts are often used to accomplish grounds maintenance work on lands not outleased. Legal aspects, negotiation and administration is the responsibility of the appropriate contracting officer. In order that monetary consideration may be adjusted, contracts should include a clause providing for negotiation of a change in price if the services under consideration are either diminished, increased, or eliminated. Contracts should include appropriate applicable conditions and specifications pertaining to land management and maintenance practices for the protection of the land involved. Several types of contracts are available:

17-2.1. Procurement Contract. A procurement contract involves payment by the Government to the contractor for grounds maintenance, rendered in establishment, control, and/or removal of vegetative cover. This contract may not extend beyond the period for which appropriations are provided for the procurement.

17-2.2. No Fund Contract. The no fund contract involves no exchange of funds for grounds maintenance service

rendered in view of other considerations received in performing this service. This contract is used where a party agrees, as a result of a procurement invitation for bid or request for proposal, to make no charge for establishment, control, and/or removal of vegetative cover or growth and is given the hay, grazing rights, trees or other growth in payment for his services. Termination clause in lieu of the standard clause may be cited as follows: "This contract will remain effective until the date of expiration, provided that it may be earlier terminated at the convenience of the Government upon thirty (30) days' notice in writing, given by the contracting officer to

the contractor." This type of contract will usually be written for a 12-month period, but may be modified when necessary to complete an integrated maintenance service program.

17-2.3. Sales Contract. A sales contract involves payment by the contractor to the Government for crops, crop residue, and grazing privileges incidental to control and/or removal of vegetative growth for grounds maintenance. This type of contract should not extend over a period longer than 3 to 5 years.

**APPENDIX A
REFERENCES**

1. AR 200-1
AFR 19-2
OPNAV INST 6240.3E
MCO P11000.8. Environmental Effects of Army Actions
Environmental Impact Analysis Process
Environmental Protection Manual
Real Property Facilities Manual, Volume V, Environmental Management
2. AR 420-74
AFR 91-26
NAVFAC P-73 Natural Resources-Land, Forest and Wildlife Management
Management and Conservaiton of Land Real Estate Manual
3. TM 5-631
AFM 126-3
NAVFAC MO-100.2. Natural Resources-Forest Management
4. TM 5-633
AFM 126-4
NAVFAC MO-100.3. Natural Resources-Fish and Wildlife Management
5. TM 5-635
AFM 126-5
NAVFAC MO-100.4. Natural Resources-Outdoor Recreation and Cultural Values
7. TM 5-820-4
AFM 88-5, chapter 4
NAVFAC DM-5 Drainage for Areas Other Than Airfields
8. TM 5-624
NAVFAC MO-102
AFR 85-8 Maintenance and Repair of Surface Areas
9. Engineer Manual No.
1110-2-5003 Planting Guidelines for Dune Creation and Stabilization
10. AR 420-76
AFR 91-21
MCO P1 1000.8. Pest Control Services.
Pest Management Program.
Real Property Facilities Manual, Volume V, "Environmental Management"
Chapter 9, Pest Management
11. TM 5-632
AFM 91-16
NAVFAC MO-310TM 5-629
AFM 91-19
NAVFAC MO-314 Military Entomology Operational Handbook
Herbicide Manual for Noncropland Weeds
12. AR 420-90
AFR 92-1
NAVFAC INST. 11320.2C
NAVFAC INST. 11320.3
MCO P11000.11 Fire Prevention and Protection
Fire Protection Program
Navy Fire Protection and Protection Standards
Fire BiA, Fire Alarm, Building Evacuation and Fire Fighting Procedures
Real Property Facilities Manual, Volume 8, "Fire Protection Program"
13. AR 40-5
AFR 127-12
AFR 161-33 Health and Environment
Air Force Occupational Safety and Health Program
The Aerospace Medicine Program
14. DA PAM 385-3
AFOSH Standard 127-31 Protection Clothing and Equipment
Personal Protective Clothing and Equipment

- | | | |
|-----|---|---|
| 15. | TM 5-830-2
AFM 88-17, Chapter 2 | Planting Turf |
| 16. | TM 5-803-5
AFM 88-17
NAVFAC P-960 | Installation Design, Chapter 1 "Planting Design" |
| 17. | TM 5-830-4
AFM 88-17, Chapter 4
NAVFAC P-905 | Planting and Maintenance of Trees, Shrubs, and Vines |
| 18. | AR 420-47
DA PAM 420-47
AFM 91-11
AFP 91-8
NAVFAC MO-213TM 5-634
NAVFAC TS-01501 | Solid Waste Management |
| 19. | TM 5-813-1
AFM 88-10, Chapter 1 | Refuse Collection and Disposal
Environmental Protection
Water Supply-General Considerations |
| 20. | TB MED 229

AFR 161-44 | Sanitary Control and Surveillance of Water Supplies at Fixed and Field Installations.
Management of Drinking Water surveillance Program Plumbing |
| 21. | TM 5-810-5
AFM 88-8, Chapter 4 | |
| 22. | MCGS 02821
MCGS 02831 | Turf
Trees, Shrubs, Ground Covers and Vines |

APPENDIX B
NATURAL RESOURCES MANAGEMENT PLAN
OUTLINE FOR PART I-GENERAL *

B-1. Introductory Material.

B-1.1. Provide a brief history of installation grounds by indicating principal land acquisition dates, military missions, and active or inactive status for the installation. Identify satellite installations and indicate their military mission and distance from the support installation. Utilize looseleaf binders to facilitate page changes involving revisions.

B-1.2. Identify principal highways, railroads, and airports serving the installation.

B-1.3. Name of principal city or town and distance from installation headquarters.

B-2. Inventory of Land Use. Prepare the information at table B-1, as appropriate, for the installation and each satellite installation separately:

* **Note:** This is written as a guide for new plans and for existing plans requiring major revisions. It is not applicable to Air Force installations.

Table B-1. Inventory of Land Use
 Improved Grounds

Improved grounds classification	Total acres	Acres maintained with				Mowing frequency
		Power mowers (5)		Tractor mowers 6)		
		Irrigated (7)	Unirrigated	Irrigated (7)	Unirrigated	Mo. (8) Yr. (9)
Lawns mowed by facilities engineer (1)	_____					
Lawns mowed by others (1)	_____					
Athletic fields (2)	_____					
Golf courses by facilities engineer	_____					
Golf courses by others	_____					
Parades and drill grounds	_____					
Post cemeteries	_____					
Private cemeteries	_____					
Airfield and heliport (landing and parking) (3)	_____					
Other improved grounds (4)	_____					
(Specify kinds and use)	_____					
Total	_____					

- (1) Include areas adjacent to buildings & structures normally described as lawns.
- (2) Include turf area of ball fields and other outdoor recreational facilities (other than golf).
- (3) Grassed landing and parking areas.
- (4) List separately such areas as: ground cover (ivy, iceplant, periwinkle), crushed rock or ravel blanket on improved grounds, other landscape planted areas, and road shoulders in improved ground areas.
- (5) Include acres mowed with hand push and self contained power units.
- (6) Include acres mowed with farm or industrial type tractor mowers.
- (7) Include acres regularly irrigated to prevent loss of turf. Do not include lawn areas in humid climate zones irrigated to preserve green color.
- (8) Use the fig. 4 if mowed once a week or four times a month during mowing season; fig. 8 if twice weekly.
- (9) Use the fig. representing the number of times mowed during the year.

Table B-1. Inventory of Land Use-Continued
 Semi-Improved Grounds

Semi-improved classification	Total acres	Mowed	Weed control	Other maintenance
Airfield and heliports (1)	_____			
Ammunition storage (2)	_____			
Antenna fields.....	_____			
Drop zones.....	_____			
Small arms ranges.....	_____			
Firebreaks (3)	_____			
Road shoulders and railroad beds and appurtenant land areas (4).....	_____			
Picnic area (5)	_____			
Wildlife food plots (6)	_____			
Other grounds (7)	_____			
Totals.....	_____			

- (1) Do not include landing and parking area.
- (2) Do not include unimproved area.
- (3) Do not include firebreaks in forest areas.
- (4) Do not include road shoulders of improved grounds or r d acres of unimproved areas.
- (5) Include picnic grounds and similar recreational areas.
- (6) Include areas planted to annual and perennial plants and browse and seed crop areas provided incidentally by timely mowing or tilling operations
- (7) Include crushed rock or gravel for dust control within semi-improved areas.

Table B-1. Inventory of Land Use-Continued
 Unimproved Grounds

Unimproved classification	Total acres	Mowed	Weed control	Other (7) maintained	Not maintained
Ammunition storage (1)	_____				
Agricultural leases (2)	_____				
Ponds, lakes and streams (3)	_____				
Pavements and railroads (4)	_____				
Buildings and structures (4)	_____				
Non-merchantable forest land (5)	_____				
Other areas (6)	_____				
Totals	_____				

- (1) Do not include semi-improved areas.
- (2) Indicate work performed by lessee and lessor (not to exceed total area leased.)
- (3) Include surface areas in "maintained" and "not maintained" columns as appropriate.
- (4) Include land area occupied and report in "not maintained" column. Do not include railroad acreage reported as maintained in semi-improved areas.
- (5) Those areas composed of tree or brush cover, not economically productive and maintained for one or more uses such as: watershed protection, soil stabilization, military training, and for natural resource values such as wildlife habitat, natural beauty, and to enhance recreation potential
- (6) Include ranges other than small arms, maneuver areas, safety and security zones, areas prescribed burned not otherwise managed, desert and swamp areas, open storage areas other than ammunition storage, and crushed rock or gravel within unimproved areas.
- (7) Specify type of maintenance performed.

COMMERCIAL FOREST LAND. TOTAL ACRES _____
 (Those areas classed as economically productive or economically
 potentially productive of wood products on a sustained yield basis.
 (AMS Code 728012-23000))

INSTALLATION TOTAL ACRES _____
 (Combined acreage of improved, semi-improved and unimproved grounds
 and commercial forest land)

B-3. Description of Items Common to Most of the Plan.

B-3.1. Climate. Longtime average monthly and annual rainfall and temperature, extremes in high and low temperature, and average spring and fall frost dates.

B-3.2. Topography.

B-3.3. Soils.

B-3.3.1. Name, location, and brief description of each principal soil type as described by the U.S. Department of Agriculture in published surveys. Where soil surveys are not available, describe the soils as to depth, texture, and underlying rock or subsoil formation in appropriate detail.

B-3.3.2. Chemical analyses of soils typical of improved grounds and other important areas which require planting. Where alkaline or saline soils occur include toxic salt content. Give name of laboratory which has tested installation soil samples and date of last test.

B-3.3.3. Mechanical analyses of surface soils and subsoils typical of improved grounds (percent of sand, silt, clay, gravel, and organic mater). Where the services of a soil specialist are available, standard soil descriptions of soil texture are satisfactory in lieu of mechanical analyses (e.g., sand, clay, clay loam, silty clay loam).

B-3.4. Natural Vegetation. List all species by common and scientific names.

B-3.4.1. For areas originally in natural woodland prior to extensive clearing and cultivation, list the principal tree and shrub species which occur in undisturbed woodland sites.

B-3.4.2. For areas originally in grassland, list the principal species of native grasses and shrubs which occur in relatively undisturbed areas. If introduced grasses have generally replaced native species, list species of dominant grasses on undisturbed railroad and highway rights-of-way.

B-3.4.3. For desert areas, list separately the tree and shrub species which occur on valley sites and on hills and slopes.

B-3.4.4. Identify native vegetative species which are important as wildlife food and cover.

B-3.4.5. Identify endangered and threatened plant species and define the area(s) in which located.

B-3.4.6. Identify noxious and poisonous plants and define in general areas in which located. Identify those which require control due to regulatory (State, county, local) measures.

B-3.5. Off-road Vehicle Areas.

B-3.5.1. Indicate area(s) designated for use.

B-3.5.2. Specify compliance with AR 210-9.

B-3.6. Drainage System.

B-3.6.1. Storm drainage (runoff control). Provide the following:

B-3.6.1.1. Drainage map will show contour elevations, boundaries of principal watersheds, location and size of principal watersheds, location and size of principal subsurface storm drains and culverts, and watershed vegetation (grassland, desert, marsh, cultivated fields, woodland).

B-3.6.1.2. History of flooding in built-up areas.

B-3.6.1.3. Width, depth, side-slope, grade, and percent fall of principal channel(s) through improved grounds, and type and condition of vegetation in channel.

B-3.6.1.4. Kinds of storm drainage structures used (flumes, spillways, drop inlets).

B-3.6.2. Tile drainage. Identify areas which are drained with field tile. Establish and maintain a site plan to indicate tile line and outlet locations and the kind and size of tile installed.

B-3.6.3. Identify marsh areas. (Note: Wetlands valuable for waterfowl and other wildlife purposes should be preserved and managed wherever possible.) Indicate plans for utilizing or managing marsh areas if determined unsuitable for wildlife management.

B-3.7. Soil Eroded Areas. Describe installation areas, including beaches, having specific soil erosion (wind or water) problems. Describe control or stabilization methods in the maintenance procedures section of the plan (para B-4.2).

B-3.8. Firebreaks. Describe the system of firebreaks used as applicable. Provide an installation map locating the firebreaks and indicating width and the type of surface maintained (tilled, grass cover, etc.). Identify those specifically constructed for forest fire protection. Describe maintenance procedures.

B-4. Management Practices and Maintenance Procedures Common to Most of the Plan.

B-4.1. Chemical Control of Vegetation.

B-4.1.1. Describe methods and herbicides (common name and percent or pounds of active ingredient) used for the vegetation or area desired to be controlled. (Include, as appropriate, all land and water areas requiring such management.)

B-4.1.2. Describe, as appropriate, noxious weeds and poisonous plants and indicate control or eradication measures, including coordination with State or local control requirements.

B-4.1.3. Include plans for periodic training and certifying appropriate personnel required to conduct the vegetation control program.

B-4.2. Soil Erosion Control

B-4.2.1. Describe measures used to control wind and water erosion, including planting, terraces, check dams, riprap, and water diversion facilities; and control of blowing sand and dust by mulching, planting, snowfence, and the like. Describe, as applicable, methods used to maintain and restore areas with rock aggregate, asphalt, or other materials for wind erosion control, including treatment kinds, rates, etc.

B-4.2.2. Describe maintenance requirements, particularly for special plantings.

B-4.3. Drainage Requirements.

B-4.3.1. Describe methods required to maintain, repair or restore existing open drainage channels and conduits.

B-4.3.2. Where flooding is a recurring problem affecting built-up areas and important roadways, or other structures, describe corrective measures and proposals for accomplishment.

B-4.4. Prescribed Burning. Within guidelines contained in chapter 10, describe areas, methods, and schedules for prescribed or controlled burning, including burning in forest areas as a silvicultural treatment. Include, as appropriate, coordination requirements relating to local and State agencies. Specify timing as related to minimum impact on desirable plant and animal life.

B-4.5. Fire Protection. Describe in detail the procedures to be used to prevent and suppress vegetative fires. Include the respective responsibilities of all cooperating agencies in fire prevention and suppression, such as between the installation and city, county, State, or other Government agencies. Define the responsibilities of supervisory personnel. Make clear the respective duties of grounds maintenance and fire control personnel so that the two groups will cooperate fully. Indicate detail of on-the-job training for grounds maintenance personnel. Assure that fire control on unimproved grounds and woodland is integrated into a workable unit including appropriate areas in satellite installations. Where applicable, prepare a fire prevention and suppression plan. Inclose a copy of the plan together with a copy of appropriate detection and suppression agreements

entered into with local and State agencies. See appendix H for the fire protection plan outline and appendix G for the cooperative agreement format.

B-4.6. Resource Requirements.

B-4.6.1. Include requirements for personnel, equipment and material necessary to perform the natural resources management activities. Identify specific requirements (personnel, equipment and material), as applicable, including the outdoor recreation and cultural values, fish and wildlife management and forest management areas of the natural resources management program:

B-4.6.1.1. Provide an organizational chart showing personnel responsible for, and/or performing, the activities within the natural resources management program. Indicate personnel by titles and grade, recognized, authorized, on hand and required. If not full-time, indicate percentage of time devoted to the natural resources management program. Include and identify personnel available from cooperating agencies.

B-4.6.1.2. Include equipment and supplies especially required due to unusual terrain, unusual vegetation, climatic or geographic conditions, etc. Include and identify equipment and supplies available from cooperating agencies. Indicate equipment required by quantity, kinds, makes, and size. Include equipment required but not available, as well as that which is available.

B-4.6.2. Indicate resource support requirements relating to agricultural and grazing outleases.

B-4.6.3. Indicate extent of natural resources maintenance requirements performed by contract. Provide typical copies of contracts.

B-4.6.4. Indicate fund support given from the following sources:

B-4.6.4.1. Appropriated.

B-4.6.4.2. Nonappropriated (private association funds, welfare funds, funds from cooperating governmental agencies, etc.).

B-4.6.4.3. From sale of special permits for hunting and fishing (21X5095). Include details: military and civilian.

B-4.6.4.4. Reimbursable funds (AR 37-100-XX account code 728012.23000).

B-4.7. Revisions. Provide for revisions at intervals sufficient to keep the plan current. A major revision should be made every 3 to 5 years. Page revisions will

be made when major revisions are unnecessary. Well prepared indigenous information within the plan such as that relating to soils, climate, land use history, and

geography, although requiring no revision, should be carried forward to the revised plan.

B-7

APPENDIX C
NATURAL RESOURCES MANAGEMENT PLAN
OUTLINE FOR PART II-LAND MANAGEMENT
AND
GROUNDS MAINTENANCE*

C-1. Description of Items Inherent to Part II of the Plan.

C-1.1. Planted Areas. Describe areas which have been planted, or established naturally, on the installation and on satellite installations.

C-1.1.1. List species of grasses or other ground cover used on

Improved grounds.

Semi-improved grounds.

Unimproved grounds.

C-1.1.2. List species used for landscape plantings:

Shade trees.

Shrubs.

Ground cover plants and vines.

C-1.1.3. Identify those parts of the installation which the landscape plan covers; explain status of implementation of the plan; and give target date for completion if not completed. (See attached annex I, "Outline For The Landscape Planting Plan.")

C-1.2. Areas Leased for Agricultural Purposes. Include the following information as applicable:

C-1.2.1. Brief history of agricultural and grazing lease program.

C-1.2.2. On an installation map, identify the following:

Tract(s) outleased, by number, acres, and use (crops, hay, pasture).

Land areas having a potential for agricultural outleasing; provide for an annual review of such areas to determine availability for outlease.

C-1.2.3. Establish a record system to provide fiscal year input on outleases for Part I of the "Installation Natural Resources Report."

C-1.2.4. Identify maintenance services and benefits

realized from leases; e.g., improved drainageways, soil erosion control, weed control, fence construction, ponds for fire protection, and permanent pasture improvement.

C-1.2.5. A copy of land use regulations required for lessee compliance.

C-1.3. Golf Courses. Provide the following descriptive information:

C-1.3.1. Brief history of course (date(s) of construction and important improvements).

C-1.3.2. Size of greens and tees.

C-1.3.3. Grass kinds on greens, tees and fairways.

C-1.4. Cemeteries.

C-1.4.1. Locate cemeteries (if any) on an installation map and identify as defined by AR 210-190.

C-1.4.2. Briefly describe degree of maintenance of all cemeteries (reference para. 3-3, AR 420-74) and for post cemeteries (reference para. 14, AR 210-190).

C-1.4.3. Indicate on the location map those cemeteries which are fenced.

C-1.5. Ammunition Storage Areas.

C-1.5.1. Number of earth covered magazines by kinds.

C-1.5.2. Condition of soil cover. Give number which require repair to restore soil cover to original grades. If other than grasses or vines are used to control erosion, so indicate.

C-1.6. Irrigation System. Describe irrigation system and give acreage and kind of area such as parade fields, golf course, and athletic fields irrigated. Describe also the type of equipment (e.g. fixed head, pop-up, quick coupling, portable pipe).

*Plant outline is not applicable to Air Force installations.

C-2. Management Practices and Maintenance Procedures Inherent to Part II of the Plan.

C-2.1. Planting. Describe methods, materials and equipment used in establishing vegetation, particularly involving areas having unusual or difficult characteristics or demanding requirements. Include tree (other than reforestation) and shrub planting on improved or semi-improved ground areas. Include tree, shrub and plant species, kind of seed, kind and analysis of fertilizer and soil amendment requirements.

C-2.2. Feeding.

C-2.2.1. Describe feeding practices required to provide the degree of maintenance desired for specific areas. Areas of special consideration are-

Turf subject to intensive foot traffic.

Vegetative cover on slopes subject to soil erosion.

Vegetative cover on soils which are shallow, droughty, inherently infertile, or highly alkaline or acid.

C-2.2.2. Itemize materials required (fertilizer, by analysis, and soil amendments such as lime and gypsum).

C-2.3. Mowing.

C-2.3.1. Prepare and maintain an installation map(s) in sufficient detail to provide the mowing information required by the land use inventory (Reference appendix B). Support the map(s) with responsibility for mowing, including that of occupants of quarters and company detachments.

C-2.3.2. Include instructions provided occupants of quarters (e.g., family housing, barracks, or BOQ's, separate or communal lawns) both Government owned and leased facilities.

C-2.4. Irrigating.

C-2.4.1. Within guidelines contained in appendix A, no. 19, and chapter 16, provide an irrigation plan for (a) all proposed systems and (b) for established systems where no plan had been developed, to include applicable features of the plan essential to efficient operation and maintenance.

C-2.4.2. List recommendations of the State irrigation specialist on the daily water consumption rate for the specific type of turf to be irrigated.

C-2.4.3. Include supervisory responsibility for operation and maintenance of the system.

C-2.4.4. Include instruction furnished occupants of quarters and family housing regarding irrigation schedules and practices.

C-2.5. Tree, Shrub and Special Ground Cover Plants.

C-2.5.1. Describe requirements for feeding, weeding (include chemical control in para. B-4.1), mulching and pruning.

C-2.5.2. Include, as appropriate, maintenance required by unusual climatic, geographic or physical conditions, or by plantings in special site situations (e.g., screening, soil stabilization, wind control, noise abatement).

C-2.5.3. Describe requirements for removal of shade trees and ornamental shrubs due to conditions such as crowding, improper site, over-age and disease.

C-2.5.4. Include, as appropriate, requirements for tree pruning (including cabling, guying and bracing) and removal by contract.

C-2.6. Policing.

C-2.6.1. Include plans for a continuing program of policing grounds areas in the built-up portion of the installation, in areas exposed to public view, in all areas where mowing equipment is used, and where drainage structures and channels are located. Examples of police items and areas are-

Minor repair of vehicular damaged turf.

Minor repair to correct soil eroded areas and restore displaced soil.

Detecting obstructions to the surface water drainage system and performing minor corrective measures.

Removing and disposing of broken branches of woody plants.

Removing obstructions to mowing equipment.

Removing excess leaves or other plant residue from improved grounds turf and landscaped areas.

C-2.6.2. Designate responsibility for accomplishing policing and indicate frequencies and priorities of performance.

C-2. 7. Disease and Insect Control and Sanitation.

C-2.7.1. Describe major diseases of turf, trees and shrubs which require control.

C-2.7.2. Identify those insects which cause major damage to turf, trees and shrubs, and which require routine control measures.

C-2. 7.3 Include comments on sanitation measures taken to help prevent, or to control, vegetative diseases and insect infestations. Typical of such measures are-

Selection of trees and shrubs for new plantings which are least likely to attract disease or insects.

Removal and disposal of plants or parts thereof which are diseased beyond practical chemical control.

Sanitation cuttings to prevent epidemic outbreaks of insects or diseases.

C-2.7.4 In coordination with the installation pest control services, indicate control measures to be taken, including requirements for personnel, material and equipment.

C-2 7.5. Include information, as appropriate, relative to

those insects and diseases affecting vegetation and which require coordination with local, State, or Federal agencies for appropriate control.

C-2.8 Work Programming. Provide for an annual work plan to determine requirements for the land management and grounds maintenance activities of the natural resources management plan. The work plan will be prepared utilizing an appropriate form (reference suggested format as annex II).

**ANNEX I to APPENDIX C
OUTLINE FOR THE LANDSCAPE PLANTING PLAN***

Note: Information and guidance for such areas as location, inventory of land use, climate, soils, drainage, natural vegetation and resource requirements are to be placed in PART I-GENERAL, of the installation natural resources management plan.

I. Introductory Information

a. Purpose of the Plan-A landscape planting plan for military installations provides a workable, long range guide to assure establishment of a pleasant environment conducive to the health, welfare, and morale of Army personnel, and to enhance the overall natural beauty of the community. The plan illustrates the arrangement of plant materials on the site and describes planting methods.

b. Brief description of areas landscaped or to be landscaped. Include acreage of grounds involved, area utilization requirements, kind of building areas to consider, and unusual site conditions requiring special plantings.

c. Native plants available and suitable for use. Identify important species of native plants which may be satisfactorily moved into the landscape environment.

II. Design Considerations-The landscape planting plan will, where required by AR 210-20, be compatible with the installation master plan. The development of a landscape planting plan suitable to the functions and character of a particular Army installation requires the professional training and skill of a landscape architect. If a trained and experienced person is not available at installation level, obtain the services of a specialist to prepare a complete plan.

III. Approved Plant List-List the species and varieties of trees and shrubs, by common and scientific names, approved for planting, indicating by suitable symbol which of them are in current use. After each species, estimate its mature height for the climate and soil conditions existing locally. Plant material listed by planting zones (based on climatic and soil conditions,

humidity, temperature ranges, and need for irrigation) is contained in the above cited technical manuals. U.S. Department of Agriculture specialists at the State and county level of the Agricultural Extension Service, have valuable information available. Installation commanders should avail themselves of this service in determining plant material adapted to their geographic area.

IV. Drawings-Prepare maps, drawings of detailed planting plans, and elevation and perspective drawings as necessary to illustrate planting requirements. The grounds of important buildings, such as headquarters, chapels, theaters, libraries, clubs, post exchanges, and other community buildings should be included.

a. Prepare a key map (scale: 1 inch to 400 feet, or other, as applicable) for installations where more than a single year's funds will be required to prepare and implement the plan. Indicate existing parade grounds, athletic areas, parks, and military areas, and identify building areas for which further landscape planting is not planned. If available, a tree cover map, prepared in accordance with AR 210-20, is suitable as a key map. On this map indicate the limits of the area to be landscaped; divide the area into priority segments and show boundaries of each; designate fiscal year dates for accomplishment of each priority segment. If a tree cover map is not used, show the general location of existing tree masses.

b. Prepare detailed drawings (1 inch to 50 feet, or larger scale) and show by symbols the location of existing plants, shrub groups, shade trees, and wind-breaks, indicating those to be removed and the locations of proposed plantings. Give sizes, quantities, and the common and scientific names of the plant species which are included on each drawing.

***Note: Plan outline is applicable to Army Installations only. See publications at appendix A, nos. 16 and 17, for guidance on design, plant material and planting operations.**

Where there are many buildings of the same kind, as may be the case with barracks and family housing, detailed plans of representative sections may be adequate to show what plantings are required.

(1) For small or relatively new installations where landscape planting may be completed from a single year's funds, prepare a detailed drawing for the entire installation.

(2) For installations where landscape planting will not be completed from a single year's funds, establish the priority of each part of the planting plan, and prepare a detailed drawing for each part, coordinating it with the key map (a above).

c. If essential for clarity, prepare elevation and perspective drawings (1 inch to 20 feet, or other scale as appropriate) for main entrances or other special features to show the proposed treatment and ultimate effect desired. Include requirements for vegetated wind barriers, screens, and noise abatement plantings.

V. Plant Material Specifications-The selection of plants that conform to the planting site requirements is of utmost importance. Adherence to guidelines contained in "American Standard For Nursery Stock," prepared by the

American Association of Nurseryman, Inc., in purchasing planting stock assures the best plants available. (See app E, no. 61.)

VI. Planting Guidelines-Good plants can enhance the planted area only if proper attention is given to planting operations, including care both prior to and following planting. Improper attention to planting objectives and procedures generally results in an unsatisfactory planting job, loss of plants, unsightly conditions and costly plant replacements.

VII. Review and Approval-Submit the landscape planting plan and major revisions to the appropriate command headquarters for approval. Include detailed drawings of the two highest priority parts of planting plans requiring more than a single year's funds with the narrative report when it is first submitted for approval. Once a year submit additional detailed drawings in order of priority, so that they reach the appropriate command headquarters not later than 1 May prior to the fiscal year in which those parts of the landscape plantings are to be completed.

Annex 11 to Appendix C

ANNUAL WORK PLANS-LAND MANAGEMENT AND GROUNDS MAINTENANCE
-MAJOR REQUIREMENTS AND ESTIMATED COSTS-

FOR FISCAL YEAR:

(SUGGESTED FORMAT)

TO:	FROM:										
LINE	JOB DESCRIPTION	JOB		WORK BY INSTALLATION FORCES				WORK BY CONTRACT		EQUIP. ACQUI. COST j	ESTIMATED TOTAL COST k
		UNIT b	AMOUNT c	MAN DAYS d	LABOR COST e	MATERIAL COST f	EQUIPMENT RENTAL COST g	AMOUNT h	COST i		
	a										
1.	Aerification	ac									
2.	Controlled burning	ac									
3.	Drainage (construction)	Lin ft									
4.	Drainage (maintenance)	Lin ft									
5.	Fertilizing (turf)	ac									
6.	Fertilizing (trees, shrubs, etc)	no									
7.	Herbiciding	ac									
8.	Insect & disease control (turf)	ac									
9.	Insect & disease control (trees, shrubs, etc)	no									
10.	Irrigation	ac									
11.	Liming	ac									
12.	Mowing	ac									
13.	Mulching	ac									
14.	Planting trees shrubs, etc)	no									
15.	Pruning	no									
16.	Soil preparation for turf establishment, renovation, etc	ac									
17.	Seeding	ac									
18.	sodding	ac									
19.	Sprigging	ac									
20.	Plugging	ac									
21.	Soil erosion control (wind/water)										
	Miscellaneous:										
22.	Administration/leave	hrs									
23.	Policing	hrs									
24.	Training classes/conferences	No									
25.	Other										
	TOTAL										

(See instructions on reverse side)

Annex II to Appendix C
Instructions For Completing
(Annual Work Plan)

- Note 1** Activities involving fish and wildlife or forest management are reported on the respective annual work plan and are not to be included on this work plan.
- Note 2** Report only those activities accomplished with appropriated funds.
- Note 3** Report costs to the nearest dollar and amounts to the nearest whole number.
- Line 2** Includes burning in critically located open areas to prevent vegetative wildfires.
- Lines 8 and 9** Insect control activities are costed to .M3200 account code.

APPENDIX D

SOURCES OF TECHNICAL ASSISTANCE

1. U.S. Department of Agriculture
Soil Conservation Service
P.O. Box 2890
Washington, DC 20013
2. U.S. Department of Interior
Fish and Wildlife Service
Public Affairs Office
18th and C Streets, N.W.
Washington, DC 20240
3. Forest Service
Office of Information
Room 3238
P.O. Box 2417
Washington, DC 20013
4. American Forest Institute
1619 Massachusetts Ave., N.W.
Washington, DC 20036
(ATTN: Publications)
5. U.S. Department of the Interior
Bureau of Land Management
Office of Public Affairs
Room 5625 Interior Building
Washington, DC 20240
6. Pesticide Hot Line (Autovon 584-3773)
U.S. Army Environmental Hygiene Agency
Pest Management and Pesticide
Monitoring Division
Aberdeen Proving Ground, Maryland 21005
7. American Sod Producers Association, Inc.
9th and Minnesota Streets
Hastings, Nebraska 68901
8. U.S. Department of the Interior
Geological Survey
12201 Sunrise Valley Drive
Reston, Virginia 22092
9. U.S. Department of Commerce
National Climatic Center
Federal Building
Asheville, North Carolina 28801

APPENDIX E
BIBLIOGRAPHY

1. Climate and Weather

Climate and Man, Yearbook of Agriculture, U.S. Department of Agriculture, 1941.

2. Diseases

Plant Diseases, Yearbook of Agriculture, U.S. Department of Agriculture, 1953.

3. Fire Protection (Vegetated Areas) (See also Hazard Reduction)

Agricultural Handbook 360., Fire Weather, Supt. of Documents, Government Printing Office, Washington D.C.

Fischer, William C. and Hardy, Charles E., Fire-Weather Observers' Handbook, U.S. Department of Agriculture, Forest Service, Intermountain Forest and Range Experiment Station, Ogden, Utah, May 1972.

Helfman, Robert S., Deeming, John E., Straub, Robert J. and Furman, R. William., User's Guide to AF-FIRMS: Time-Share Computerized Processing for Fire Danger Rating, U.S. Department of Agriculture, Forest Service, Rocky Mountain Forest and Range Experiment Station, General Technical Report RM-15, Ft. Collins, Colorado, August 1975.

National Fire Protection Association., Chemicals for Forest Fire Fighting, No. FSP-19A, Boston, Massachusetts, 1977.

Russell, John I., National Fire Danger Rating System-1978: Use and Interpretation, U.S. Department of Interior, Bureau of Land Management, Boise Interagency Fire Control Center, Boise, Idaho, 1978.

U.S. Department of Agriculture., Southern Forestry Smoke Management Guidebook, Southeastern Forest Experiment Station Asheville, N.C. and Southern Forest Fire Laboratory, Macon, GA.

4. Grasses

Hitchcock, A. S., Manual of the Grasses of the U.S., Miscellaneous Publication No. 200, U.S. Department of Agriculture, 1935.

Grass Varieties in the United States, Agricultural Handbook No. 170, Agricultural Research Service, U.S. Department of Agriculture, 1972.

5. Hazard Reduction/Fuel (Vegetation) Management (See also Fire Protection)

Bentley, Jay R., Conversion of Chaparral Areas to Grassland, U.S. Department of Agriculture, Forest Service, Pacific Southwest Forest and Range Experiment Station, Agricultural Handbook No. 328, Berkeley, California, 1967.

Blaisdel, J. P., Ecological Effects of Planned Burning of Sagebrush-Grass Range on the Upper Sanke River Plains, U.S. Department of Agriculture, Technical Bulletin 1075, 1953.

Green, Lisle R., An Experimental Prescribed Burn to Reduce Fuel Hazards in Chaparral, U.S. Department of Agriculture, Forest Service, Research Note PSW-216, 1970.

Green, Lisle R. and Schimke, Harry E., Guides for Fuel Breaks in the Sierra Nevada Mixed-Conifer Type, U.S. Department of Agriculture, Forest Service, Pacific Southwest Forest and Range Experiment Station, Berkeley, California, 1971.

5. Hazard Reduction/Fuel (Vegetation) Management (See also Fire Protection) (Continued)

U.S. Department of Agriculture, Fuelbreaks and Other Modification For Wildland Fire Control, Forest Service, Pacific Southwest Forest and Range Experiment Station, Berkeley, CA., Agriculture Handbook No. 499, April 1977.

U.S. Department of Agriculture, Mechanical Methods of Chaparral Modification, Forest Service Pacific Southwest Forest and Range Experiment Station Berkeley, CA., Agricultural Handbook No. 487, April 1976.

U.S. Department of Agriculture, Low-volume and Slow-burning Vegetation for Planting on Clearings in California Chaparral, Forest Service, Pacific Southwest Forest and Range Experiment Station, Berkeley, CA., Research Paper PSW-124/1977.

6. Planting, Design and Materials.

American Standard for Nursery Stock, 1973 Edition, American Association of Nurserymen, 230 Southern Building, Washington, D.C. 20005.

Landscape for Living, Yearbook of Agriculture, U.S. Department of Agriculture, 1972.

Wyman, Donald, Shrubs and Vines for American Gardens, The MacMillan Company, 1949/1969.

Wyman, Donald, Trees for American Gardens, The MacMillan Company, 1951/1965.

7. Soil

Soil Yearbook of Agriculture, U.S. Department of Agriculture, 1957.

Diagnosis and Improvement of Saline and Alkali Soils, Agricultural Handbook No. 60, 1954 (reprint 1969).

8. Soil Conservation

Kay, Burgess L., Hydro-seeding, Straw, and Chemicals for Erosion Control, University of California, Agronomy Progress Report No. 77, Davis, California, 1976.

Kay, Burgess L., Pellet-Inoculated Legume Seeds are OK in Hydro-Mulching, University of California, Agronomy Progress Report No. 44, Davis, California, 1972.

Perry, H. Douglas, Wright, D. L. and Blaser, R. E., Producing Vegetation on Highway Slopes Concurrently with and Subsequent to Highway Construction, Virginia Polytechnic Institute and State University, Department of Agronomy, Research Division, Project Report No. 40, Blacksburg, Virginia, 1975.

Resource Conservation Glossary, Soil Conservation Society of America, Ankeny, Iowa.

U.S. Department of Agriculture, Soil Conservation Service, Standards and Specifications for Soil Erosion and Sediment Control in Developing Areas, College Park, Maryland, 1975.

U.S. Department of Agriculture, Soil Conservation Service, Engineering Field Manual for Conservation Practices, 1969.

U.S. Environmental Protection Agency, Erosion and Sediment Control: Surface Mining in the Eastern

U.S., Office of Research and Development, Book 1 (Planning) and Book 2 (Design), Cincinnati, Ohio, October 1976.

9. Weed Control

Selected Weeds of the United States, Agricultural Handbook No. 366, Agricultural Research Service, U.S. Department of Agriculture, 1970.

10. Professional Organizations

American Forestry Association
1319 18th Street, N.W.
Washington, DC 20036

10. Professional Organizations (Continued)

American Horticultural Society
Mount Vernon, Virginia 22121

American Society for Horticultural Science
Mount Vernon, Virginia 22121

American Society of Agronomy
677 South Segoc Road
Madison, Wisconsin 53711

International Society of Arboriculture
P.O. Box 71
5 Lincoln Square
Urbana, Illinois 61801

National Arborist Association
3537 Stratford Road
Wantagh, New York 11793

National Landscape Association
230 Southern Building
Washington, DC 20005

Professional Grounds Maintenance Society
1750 Old Meadow Road
McLean, Virginia 22101

Society of American Foresters
5400 Grosvenor Lane
Bethesda Maryland 20014

Soil Conservation Society of America
7515 Northeast Ankeny Road
Ankeny, Iowa 50021

U.S. Golf Association Green Section
Golf House
Far Hills, New Jersey 07931

11. Books

Conover, Herbert S., *Grounds Maintenance Handbook*, 4th ed, McGraw-Hill Book Company, New York, New York, 1977.

Hepworth, H. H. and Fine, R. R., *Herbicide Use and Nomenclature Index*, Oregon State University, International Plant Protection Center, Department of Farm Crops, Corvallis, Oregon, 1971. (Note: Request latest revised edition.)

Herbicide Handbook Committee, *Herbicide Handbook of the Weed Science Society of America*, 3d ed., Weed Science Society of America, Champaign, Illinois, 1974.

Musser, Howard B., *Turf Management* 2d ed., McGraw-Hill Book Company, New York, New York, 1962.

Pirone, Pascal P., *Diseases and Pests of Ornamental Plants*, 3d ed., John Wiley and Sons, Inc., New York, New York, 1978.

Pirone, Pascai P., *Tree Maintenance*, Oxford University Press, Inc., Fairlawn, New Jersey, 1978.

Wilson, Lois, *The Complete Gardener*, Hawthorn Books, Inc., New York, New York, 1972.

Wyman, Donald, *Gardening Encyclopedia*, The MacMillan Company, New York, New York, 1077. I12 Journal American Horticulturist, American Horticultural Society, Mount Vernon, Virginia 22121.

12. Journals (Continued)

Flower and Garden Magazine, 4251 Pennsylvania Avenue, Kansas City, Missouri 64111.

Ground Maintenance, Intertec Publishing Corporation, 9221 Quivira Road, P.O. Box 12901, Overland Park, Kansas 66212.

Horticultural Science, American Society for Horticultural Science, Mount Vernon, Virginia 22121.

Journal of the American Society for Horticultural Science, American Society for Horticultural Science, Mount Vernon, Virginia 22121.

Plants and Gardens, Brooklyn Botanic Gardens, Brooklyn, New York 11225.

Weeds, Trees and Turf, The Harvest Publishing Company, 9800 Detroit Avenue, Cleveland, Ohio 44102.

13. Other

Historic Preservation: Administrative Procedures, TM 5-801-1, and Historic Preservation: Maintenance Procedures, TM 5-801-2.

Water, Yearbook of Agriculture, U.S. Department of Agriculture, 1955.

APPENDIX F
SAMPLE AGREEMENT FOR FIRE SUPPRESSION SERVICE
AND EQUIPMENT

THIS AGREEMENT, made and entered into this ____ day of ____ 19__ at (name of installation), by and between the Installation Commander, (name of installation), hereinafter referred to as the Installation Commander, and the Forestry Commission (or Board) of the State of _____, hereinafter referred to as the Commission, witnesseth:

WHEREAS, the Installation Commander is responsible for the suppression of forest fires on ____ acres of Federally owned lands within the boundaries of (name of installation); and

WHEREAS, the Commission is responsible for the suppression of forest fires on privately owned lands located within the counties surrounding (name of installation); and

WHEREAS, in view of the live and moving characteristics of forest fires, it is the desire of the Installation Commander and of the Commission to create more effective protection for both Federally owned and privately owned lands within the areas of mutual interest adjacent to the boundaries of (name of installation).

NOW, THEREFORE, in consideration of the mutual promises hereinafter made, the Installation Commander and the Commission agree as follows:

1. The Installation Commander shall have the right to take necessary action to suppress any fire which shall be deemed by him or his authorized representative to be immediately endangering the installation of (name of installation), or any part thereof, and which shall exist within an area designated as follows:

That portion of land adjacent to (name of installation), and bounded on the west side by ____ Highway ____ from _____, to State Road ____ on the south side by State Roads ____ and ____ to the Railroad and thence along said railroad to the ____ River; on the east side by the ____ River to the ____ Railroad; and on the north side by the ____ Railroad to ____.

2. The Commission shall have the right to take any action necessary to suppress any fire which shall be deemed by the duly authorized officials of the Commission to be immediately endangering any lands beyond the boundaries of (name of installation), and which shall exist within an area designated as follows:

"That portion of land within (name of installation), which is immediately adjacent and contiguous to the outer boundary of the installation and which extends at a width of one quarter of a mile around the entire installation. " The inner boundary of such area shall not be marked or otherwise indicated on the ground, but shall consist of an imaginary line existing only in the contemplation of the parties hereto.

3. The Installation Commander shall render assistance to the Commission whenever such assistance is requested, in the suppression of any fire which in the judgement of the Installation Commander or of his duly authorized representative is potentially dangerous to the installation of (name of installation) or any part thereof, provided that personnel and equipment of (name of installation), are reasonably available for such service.

4. The Commission shall render assistance to the Installation Commander whenever such assistance is requested, in the suppression of any fire which in the judgement of the duly authorized officials of the Commission is potentially dangerous to any private land of the State of _____, provided that personnel and equipment employed by or for the Commission can be spared for such service.

5. Whenever any personnel or equipment of (name of installation), are engaged in the suppression of fire outside of the installation boundary, such personnel and equipment shall remain under the direction and supervision of the Installation Commander or his duly authorized representatives. However, the Installation Commander or his duly authorized representatives shall employ such personnel and equipment as to render full cooperation with duly authorized representatives of the Commission. Whatever rights and authority the Commission shall at the time possess for entry into private lands in the pursuance and suppression of fire shall be and the same are hereby delegated to the Installation Commander and his duly authorized representatives.

6. Whenever any personnel or equipment employed by or for the Commission are engaged in the suppression of fire inside the installation of (name of installation) , they shall act under the direction and supervision of the Installation Commander and such of his authorized representatives as shall be present.

7. A report shall be made of any fire suppressed by either of the parties hereto in the area of land for which the other party is responsible.

8. No liability or responsibility is assumed by either of the parties hereto for any damage to property, or for any damage to equipment used by the other party, or for any personal injury to personnel employed by the other party which may result from fire suppression activities conducted by one party at the request of the other party as provided in paragraphs 3 and 4 above. Each party to this agreement waives all claims against every other party for compensation for any loss, damage, personal injury, or death occurring in consequence of the performance of this agreement.

9. No warranty is made by either of the parties hereto as to the quality or continuity of services which may be furnished under this agreement. Each of the parties reserves the right to withdraw its personnel and equipment from the scene of a fire whenever circumstances may require that such personnel or equipment be employed elsewhere, and such withdrawal is not to be considered a breach of this agreement.

10. Each of the parties hereto shall prepare a written plan for coordinating in detail the operations under this agreement and shall submit a copy of such plan to the other party.

11. The services provided in this agreement shall be furnished by both parties without monetary charge.

12. This agreement shall remain in full force and effect until it is terminated. Either party may terminate this agreement at any time, with or without cause, provided that the party so desiring to terminate the same shall give unto the other, at least 30 days prior to the proposed date of termination, a written notice of such intention.

IN WITNESS WHEREOF, we have hereunto set our hands the place, day, and year first above written.

(Name and rank)
(Name of installation)

Installation Commander
FORESTRY COMMISSION OF THE STATE OF

By (Name and title)

APPENDIX G
EXAMPLE OF COOPERATIVE AGREEMENT

COOPERATIVE AGREEMENT

Between

The United States of America, Department of the _____

(installation name)

And

The (state) Department of Conservaiton, Division of Forestry,

Effective this _____ day of _____ 19____, for the purpose of providing mutual assistance in forest-fire detection and suppression when forest fires are burning on, or adjacent to and threatening, the lands of the (installation name) located in County, (state), approximately _____ miles west of (town or city), (state), and hereinafter referred to as the Installation.

WHEREAS the Commander of the Installation has jurisdiction over, and is responsible for the security, proper maintenance, and protection of the forested and other lands of the Installation, and

WHEREAS the (state) Department of Conservation, Division of Forestry, hereinafter referred to as the Division of Forestry, is the official agency of the sovereign state of (State) for the protection from and suppression of forest fires on State and private lands within said State, and is authorized by law to provide assistance to, and cooperate with, Federal and other public and private organizations and agencies owning or operating forest lands within said State,

NOW, THEREFORE, it is mutually agreed as follows, subject to cancellation or modification by either party hereto on 60 days' written notice to the other:

1. The Division of Forestry will use facilities at its command to locate and report to the Installation any and all fires on and in the vicinity of the Installation, and will provide any available manpower and equipment to suppress, or aid in suppressing, such fires as may be on or endangering the Installation.

2. The Installation Commander will provide such personnel and equipment as he may deem available and necessary to assist the Division of Forestry in suppressing fires off the Installation that are threatening or endangering the security of the Installation.

3. Technical direction of suppression efforts on off-post fires will be the responsibility of the designated Division of Forestry officer; technical direction of suppression efforts of fires burning on the Installation will be the responsibility of the official designated by the Installation Commander.

4. When Division of Forestry personnel are not available to take suppression action on fires threatening or endangering the Installation, the Installation Commander will take prompt action as becomes necessary.

5. In the event that a fire on the Installation reaches disaster proportions beyond the experience and ability of the Installation Fire Boss to control, the Division of Forestry will, on request, provide a man of the necessary qualifications to take full charge of the suppression activities.

6. Each party to this agreement waives all claims against every other party for compensation for any loss, damage, personal injury, or death occurring in consequence of the performance of this agreement.

7. Representatives of the Division of Forestry and of the Installation Commander will meet at the call of either party hereto to discuss and recommend amendments, changes, and additions to this agreement that are determined to be essential to keep the agreement current and effective.

APPROVED AND ACCEPTED as of this _____ day of _____ 19____.

For the State of _____

Division of Forestry.

For the Department of the _____

(installation name)

(Name)

(Name)

(Title)

(Title)

APPENDIX H.
NATURAL RESOURCES FIRE PROTECTION PLAN

1. General. Describe the overall approach to fire protection. Include a summary of fire protection activities and definite assignments of responsibility for each phase of an activity.

2. Categories. Fire Protection is divided into three categories:

a. Prevention.

(1) *Annual Analysis.* Include a schedule of annual inspection and analysis of fire reports for each fire season with names of board members making the analysis. State how forest, range, brush, and grass fire protection is to be improved.

(2) *Education.* Describe how posted signs, in stallation newspaper, daily orders, movies, and other devices are used to keep personnel fire prevention- and protection-conscious. Include a copy of the National Fire Danger Rating System (NFDRS) in the appendix of the plan.

(3) *Fuel Reduction Program.* Include firebreak construction and maintenance schedule, slash treatment requirements, and vegetation conversion and prescribed burning plans. Prescribed burning plans should provide burning schedules by location, time of year, wind direction and velocity, humidity, soil moisture conditions, and temperature ranges. Describe methods and equipment to be used and indicate relationship of prescribed burning to silvicultural treatments where (when) applicable. Describe procedure for obtaining approval for prescribed burning. Prior to burning an area, appropriate local and state air pollution agencies will be contacted for their recommendations and concurrence. Military regulations on environmental impact assessments will be complied with as appropriate.

b. Preparedness.

(1) *Organization.*

(a) List personnel by responsibilities, assigned fire duties, and name, with telephone number or other means of reaching them in an emergency. This may be in narrative form or on an organization chart. Include the names of leaders (and alternates) and all experienced personnel considered

qualified to serve as line and sector bosses and an organization chart for multiple-sector fire.

(b) Place in the appendix a copy of each current cooperative agreement and instructions for requesting, through higher authority, additional aid as necessary. Arrange for daily communication of fire danger rating from cooperating local forest/range fire-fighting agencies.

(2) *Training.* Outline training plans for both civilian and military fire fighters and prepare a training exercise SOP for field commanders.

(3) *Detection System.*

(a) Describe procedure for accurately locating fires.

(b) List available and required detection facilities including-

1 Lookout stations by designation, location, ownership, height, area of usefulness, equipment, and available communications system. When located on military lands, list available facilities for tools and equipment.

2 Helicopters and light planes by types, numbers, and ownership. Indicate whether radio-equipped and explain procedure to follow when service is required.

3 Ground patrols by type of organization (military police, etc.), transportation, and devices for locating fires. Describe how to use.

(4) *Communications System.*

(a) Describe the existing system and list additional proposed facilities.

(b) Name office to first receive reports of fires (i.e., fire department, natural resources office, or military police).

(c) Include a map of the communications systems, present and proposed, in the appendix.

- (d) Describe procedures for contacting cooperating agencies for fire-fighting assistance.
 - (e) Describe procedures to advise adjacent landowners of installation forest, range, brush, and grass fires.
- (5) *Transportation System.*
- (a) Firebreak, Road, and Trail System. List separately mileage of firebreaks, roads, and trails. Classify them on the basis of types of equipment for which each is passable. Justify, where necessary, additional firebreak requirements. Specify maintenance schedule of firebreaks. Specify use of chemical retardants where appropriate. Locate both existing and proposed roads, trails, and firebreaks on a map in the appendix.
 - (b) Transportation Equipment. List kinds and numbers of motor vehicles available, personnel capacity of each, and fire-fighting equipment each one carries. Where necessary, describe additional requirements and estimate cost.
- (6) *Water Supplies.* Identify sources of available water for fire camps, backpack pumps, and pumpers and include a location map in the appendix. List needed additional facilities and estimated cost.
- (7) *Tools, Supplies, and Equipment.* List items not included in b(3) through b(6) above, both existing and required. Give estimated cost for items to be

purchased. Indicate location of all-fighting equipment on the Fire Protection Map in the appendix. Also identify auxiliary equipment which can be called upon in case of emergency.

c. *Suppression.*

- (1) *Action Following Report of Fire.* Explain the procedure to be followed after the report is received (para 2b(4) (b)). Describe procedure to be followed for fires originating off the installation. The nearest state or Federal forestry office will be notified and kept in communication as to the progress of a fire. This will be spelled out in the cooperative fire-fighting agreement.
 - (2) *Methods of Attack.* Describe methods of attack and kinds of equipment to be used for fires in the one or several topographic- and vegetative-type area(s). Define safety requirements for personnel and equipment. Prescribe crew and equipment requirements for fires in each problem area.
 - (3) *Mop-up.* Describe mopping-up procedures for fires of various types.
- d. *Fire Reports.* Describe procedures used by the nearest state or U.S. Forest Service office or in Alaska, by the Bureau of Land Management for estimating damage; use these procedures for statistical reporting unless accurate factual data are available. In the appendix, include a model for the report and appropriate instructions.

APPENDIX I

WOODLAND AND GRASS		FIRE REPORT			For use of this form, see AR 385-12; the proponent agency is the Office of the Chief of Engineers.		REPORTS CONTROL SYMBOL ENO-7(R3)			
1. STATION Fort Greentree, GA.		2. DATE OF FIRE 3 Mar 79		3. TIME 1100 A. M. P. M.		4. EXACT LOCATION OF FIRE 873 - 940				
5. DISCOVERED BY Troops Using Range			6. METHOD OF NOTIFICATION Tele. to Fire Dept			7. DATE AND TIME FIRE OUT 3 Mar 79, 1700 hrs.				
8. BUILDING NO. NA	9. KIND OF BUILDING NA	10. NUMBER OF STORIES NA	11. DIMENSIONS (Feet) NA WIDTH NA LENGTH		12. CONSTRUCTION (Type of materials) (a) WALLS NA		(b) FLOOR NA	(c) ROOF NA	(d) INTERIOR FINISH NA	
13. OCCUPANCY NA		14. DESCRIPTION OF DAMAGE TO— (a) BUILDING NA							(b) CONTENTS NA	
15. OTHER PROPERTY DAMAGED 27 acres longleaf pine 4.1"-10"DBH, satisfactorily stocked, natural origin							16. CASUALTIES (Number) (a) INJURIES 0		(b) DEATHS 0	
17. MAKE OF HEAD AUTOMATIC SPRINKLERS NA		18. SYSTEM (Check) WET NA		19. NUMBER OF HEADS OPENED NA	20. OPERATION (Check one) <input type="checkbox"/> SATISFACTORY <input type="checkbox"/> UNSATISFACTORY NA		21. PROTECTION RESTORED DATE NA TIME			
22. NAME AND TYPE OF SYSTEM AUTOMATIC FIRE ALARM NA		23. ALARM (Check) (a) CONNECTED TO FIRE DEPARTMENT NA		(b) LOCAL NA		24. OPERATION (Check one) <input type="checkbox"/> SATISFACTORY <input type="checkbox"/> UNSATISFACTORY NA				
25. HOSE STREAMS (Number, size, length of hose lines, and diameter of nozzle) NA		26. FIRE EXTINGUISHERS (Number, type, and size) NA								
27. MOTORIZED FIRE APPARATUS RESPONDING (a) NUMBER 2				(b) CLASS 5 - Ton	(c) USA REGISTRATION NO. 1J3940		1J3941			
28. FIRE DEPT. PERSONNEL RESPONDING (a) NUMBER CIVILIAN 4				(b) NUMBER MILITARY 20						
29. CAUSE 50 Cal. Tracers ignited pine needles and grass		30. FACTORS CONTRIBUTING TO EXTENT OF DAMAGE Firing into unprepared area during high danger period					31. PREVIOUS INSPECTION (a) DATE NA			(b) BY NA
32. DESCRIBE OCCURRENCE (Use additional sheets, if necessary) a. Fire was reported by troop unit (Designation i.e. 549th Combat Battalion) who took initial control action. This resulted in slowing down spread of fire. One plow unit arrived at 1145 hours 3 Mar 1979, second plow unit arrived at 1430 hours 3 Mar 1979. b. Fire was controlled at 1700 hours, 3 Mar by completion of plowed lines and back firing. c. Arrival of second plow unit was delayed for the following reasons: (1) lack of an operator being readily available since the fire occurred on a weekend and (2) the plow unit was deadlined for minor repairs and was not available until deficiencies were corrected on an emergency basis. d. Lessons learned: (1) No firing will be done into such areas before preparation by burning and completion of firebreaks. (2) The minimum number of trained operators of fire fighting equipment will be readily available. <p style="text-align: right;">(continued)</p>										
AMOUNT OF LOSS		33. ARMY (a) BUILDING \$ 0		(b) CONTENTS \$ 0	(c) OTHER \$ 324.00	(d) TOTAL \$ 324.00	34. NON-ARMY \$ 0			
35. REVIEWED BY J.R. DOE, COL, CE FACILITY ENGINEER (Signature)				5 Mar 1979 (Date)		36. APPROVED BY I.C. FLAME, MG, USA Commanding (Signature)		9 Mar 1979 (Date)		

DA FORM 3985
1 DEC 72

REPLACES DA FORM 5-2, 1 OCT 64, WHICH WILL BE USED.

32. DESCRIBE OCCURRENCE (Cont)

(3) The assigned fire fighting equipment will be promptly repaired in the future and returned to the Forestry unit for use in combating fires.

(4) Some delay was experienced in reaching forest fire fighting crews due to the fire having occurred on a weekend. In the future a proper size crew will be kept on duty when predicted burning conditions show bad fires can occur. Overtime procedures will be utilized when economic considerations justify it, i.e. less costs by this system than maintaining additional personnel on the job full time.

e. Burning conditions, Class 3, Burning Index 10, wind in gusts of 15 to 20 miles per hour.

SAMPLE

APPENDIX J HYDRO-MULCHING

J-1. Definition. Hydro-seeding is a method of planting seed by spraying a slurry of seed and water onto the soil with a hydro-seeding machine. When fertilizer and wood cellulose fiber mulch are added to the slurry, the planting process is referred to as hydro-mulching. This one step method of planting seed or sprigs has been made possible by extensive research in the use of wood cellulose fiber as a mulch. Mulches conserve soil moisture, moderate soil temperature, reduce soil erosion, improve soil properties, and protect young seedlings from hot, drying sun; and, in areas subject to freezing, mulched soils have less heaving and thawing action. Typical areas which may be hydro-mulched include lawns, parks, playgrounds, golf courses, housing developments, highways, and reservoir dams.

J-2. Site Preparation. Hydraulic seeding and/or mulching, as used for turf establishment and control of soil erosion, are not substitutes for sound engineering and agronomic practices. The engineer must design the necessary structures (e.g., diversion terraces and outlets) to control surface water. All drainage and diversion structures, temporary and permanent, should be in place before final grading is completed. In seeding or sprigging, the plant species should be the best for the local, planting should be done during the proper season, and the fertilizer should have the appropriate ingredients. Lime, as may be required, should be applied immediately before or during the initial phase of the seedbed preparation for hydro-mulching.

J-3. Fertilization. In hydro-mulching, the fertilizer (pellet or liquid), seed, and wood fiber are mixed uniformly with water to form a slurry. In hydro-mulching, as in conventional seeding, too much fertilizer or the wrong kind can burn young, tender plants and result in seeding failure. In studies of the growth and development of grass-legume mixtures, research has proven that nitrogen favors grass more than legumes. High rates of nitrogen fertilization will reduce the legume population and increase the grass. For this reason, if a grass-legume mixture is desired, nitrogen fertilizer (not phosphate and potassium) should be limited. After initial establishment of a grass-legume seeding with a complete fertilizer (NPK), a maintenance fertilizer should be applied at the ratio of 0-1-1, or a similar ratio.

Fertilizer kind and rate should be as prescribed by laboratory soil test.

J-4. Seeding Grasses and Legumes.

J-4.1. Optimum Planting Seasons. Hydro-mulched plantings have been more successful when applied during the optimum planting seasons when temperature and moisture conditions are more conducive to successful seed germination and establishment. See paragraph 15-5.14, Seasons for planting.

J-4.2. Stress (Non-optimum) Seasons. Experience, as a whole, has shown that during the stress seasons, straw or hay is more effective than wood cellulose fiber as a mulch for establishing and protecting a young, developing vegetative cover. Straw or hay mulching is a slightly different process from hydro-mulching and requires a power mulcher (straw-blowing machine). A three step method which has proven effective for vegetative establishment during the stress seasons is: hydro-seeding, applying straw mulch (1 to 2 tons per acre), and hydro-mulching with wood cellulose fiber (750 to 1,500 pounds per acre) on top of the straw. The hydro-mulch acts as a tackifier, holding the straw in place to protect young seedlings from heat and cold, conserve moisture, and reduce soil erosion and water runoff.

J-4.3. Legume Inoculation. Pellet inoculation of legume seed, as developed by the University of California at Davis, is one of the more effective, current methods of inoculation, especially for use in the hydro-seeding and hydro-mulching processes. The pellet method is described in "Pellet-Inoculated Legume Seeds are OK in Hydro-Mulching" (app E, no 8). See paragraph 15-5.15.1 for additional information on legume inoculation.

J-4.4. Hydro-seeding. Hydro-seeding, or hydraulic seeding, is the spraying of a slurry of seed and water on soil after the seedbed has been properly prepared. A piece of equipment designed for hydro-mulching is also capable of hydro-seeding. Research has demonstrated that hydraulic seeding equipment fitted with a gear-type pump does less damage to seed germination than a

centrifugal pump during the agitating and pumping process.

J-4.5. Hydro-mulching. Hydro-mulching is the spraying of a mixed slurry of turf-establishment materials such as water, seed or springs, fertilizer, and wood cellulose fiber on a prepared seedbed. Hydro-mulching is used throughout the United States on many different types of land areas including roadsides, strip mine reclamation, fueling station berms, earth covered storage areas, lawns, and athletic fields. Appendix K contains specification guidelines for hydro-mulching.

J-4.6. Hydro-sprigging. On small turf areas, such as golf putting greens and high-visibility lawns, where a quick and uniform grass propagation must be accomplished vegetatively by using the stolons (runners) or rhizomes (roots) of grasses such as Bermuda, St. Augustine, creeping bentgrass, and Zoysia, the hydro-sprigging method may be used. The living sprigs can be spread uniformly on the ground and hydro-mulched to form a protective blanket over the sprigs, or the sprigs can be nixed in a slurry with fertilizer, wood cellulose fiber, and water in the hydro-mulcher and applied to a prepared seedbed. Too many sprigs in the slurry can cause significant clogging in the machine. Both hydro-sprigging and hydro-mulching can speed up turf establishment at a considerable savings in hand labor, cost, and time. However, hydro-sprigging is not normally recommended for large, semi-improved or unimproved land areas.

J-5. Wood Cellulose Fiber as Mulch. Wood cellulose fiber should be used at the rate of 1,500 to 3,000 pounds per acre with the seed and fertilizer in a water slurry. The mulch is manufactured with a green dye which helps monitor its application and gives a pleasing appearance. Wood cellulose fiber is packaged in 50-pound bags for easy handling. For additional information on wood cellulose fiber as a mulch, see table 7-1.

J-6. Straw or Hay as Mulch. Straw is an excellent natural mulch for stabilizing soil, encouraging seed germination, and speeding plant growth. Research has shown, in many instances, that straw excels in turf establishment when compared to other mulches. However, straw does have the following disadvantages: it may be weedy; it is difficult to apply uniformly on a windy day; it is flammable; and it must be partially incorporated into the soil by disking, preferably with a notched coulter, or held in place with a sprayed tackifier such as asphalt emulsion. The use of asphalt emulsion is objectionable in some situations because it is "messy" and can cause real problems if it drifts onto cars,

houses, or other objects. Asphalt emulsion, SS-1, may be applied as a tackifier at the rate of 400 to 600 gallons per acre. The Asphalt Institute recommends 484 gallons per acre. Six hundred gallons per acre is the suggested rate when applied on steep slopes, in areas of high wind, and during the winter months. Terra Tack II, a clear, viscous chemical extracted from seaweed, is also used as a tackifier. It is sold as two parts: the alginase and a gelling agent. When properly nixed with water and applied at the rate of 750 to 1,500 gallons per acre, an insoluble network or binding membranes is formed. The finished product is nonstaining and easy to clean up. Proper mixing is essential and requires agitation with a centrifugal pump; it will not mix adequately in a gear-pump hydro-seeder. The 1,500 gallons-per-acre rate should be used on steep slopes and in areas of high wind. Hydro-mulching with 750 to 1,500 pounds of wood cellulose fiber per acre applied as an overlay or tackifier is very effective for holding straw in place. Straw, when properly anchored and applied at the rate of 2,000 to 4,000 pounds per acre, provides a good and long-lasting mulch. For additional information on straw or hay as a mulch, see table 7-1.

J-7. Equipment and Operation. Hydraulic seeding and mulching equipment is manufactured in a number of sizes. Basically, the sizes are designated by water-holding capacity of the water tank. A unit is comprised of a water tank with an agitation system for mixing and holding the slurry, a pump with a gun for application, and an engine to power the agitator and the pump. The job can be done by two or three people, including a driver. To start the hydro-mulching process, the tank is loaded about half full with water. Depending on the size of the unit, the tank will hold from 350 to 3,000 gallons. The water enters either through the loading hatch in the top of the tank or through a special coupling built into the machine. The water source can be a hydrant or a river, stream, or lake. Water trucks are sometimes used for fast and efficient on-site loading. The seed, fertilizer, and mulch are added through the loading hatch while the tank continues filling with water. Agitation within the tank mixes the materials into a homogeneous slurry. When the load is fully mixed, the operator can begin spraying. Horizontal and vertical movements of the gun give complete, even ground coverage. Depending on the equipment and nozzle used, the spraying range will be from 10 to 200 feet or more. Hoses up to 300 feet long

and auxiliary pumps can be used to increase the range and reach less accessible areas.

J-8. Production Time. A two-man hydro-mulching crew can apply the mulch slurry effectively and efficiently with only a few hours of on-the-job training. The time required to do a job depends on the size of the area, the amount of mulch required per acre, the type of plant material (seed or sprigs) used, the source and location of water for filling the machine, and the size of the machine. In an 8-hour day, an efficient two-man crew with an 800-gallon hydro-mulcher can do approximately five normal-sized home lawns, or an apartment complex containing 40,000 to 60,000 square feet, or a football field or similar open area containing up to 100,000 square feet. These production times are based on actual experience and reflect the use of seed, fertilizer, water, and mulch.

J-9. Hydro-mulching Costs. The following breakdown indicates estimated (1978) in-house costs per acre for hydro-mulching a 30-acre project with a large machine (1,500 to 3,000 gallons):

2,000 pounds wood cellulose fiber (premixed with tackifier)	\$300.00
22 pounds Bermuda grass seed at \$2.25 per pound	49.50
500 pounds 12-12-12 fertilizer	30.00
Labor: 1/3 day for two men at \$4.50 per hour	24.00
Other gas, oil water, miscellaneous	5.00
Machine amortization and maintenance	7.50
Truck amortization and maintenance	2.50
	\$418.50

Cost per acre
\$418.50 divided by 43,560 equals
approximately one cent per square foot.

The above typical multi-acre job represents average application and quantity purchase of materials on a large job site with water readily available. The above projected costs do not include site preparation, liming, and seedbed preparation.

J-10. Mowing. See paragraph 15-5.19.1 for initial mowing.

J-11. Recommendation. Consideration should be given to studying the reports, "Producing Vegetation on Highway Slopes Concurrently with and Subsequent to

Highway Construction" and "Hydro-seeding, Straw, and Chemicals for Erosion Control" (app. E, no. 8). After these reports have been studied, it is recommended that land management personnel spend a day with an experienced, competent hydro-mulching crew while they are actively hydro-mulching. Then objective consideration can be given to the practical need for acquisition of a hydro-mulcher for one installation or for joint use on several installations within an area.

J-12. Specifications for Wood Cellulose Fiber Mulch.

J-12.1. Mulch with Tackifier.

J-12.1.1. The fiber will be processed from whole wood chips manufactured specifically for standard hydraulic mulching equipment. Fiber shall not be produced from recycled material such as sawdust, paper, or cardboard.

J-12.1.2. The fiber will include a colloidal, polysaccharide tackifier which will be adhered to the fiber to prevent separation during shipment and to avoid chemical agglomeration during mixing within hydraulic mulching equipment. The tackifier will represent 3 percent (plus or minus 0.05 percent) of the total air-dry weight of the unit package at the time of manufacture. The material will be homogeneous within the unit package. It will have no toxic effect when combined with seed or fertilizer.

J-12.1.3. The moisture content of the fiber will not exceed 12 percent (plus or minus 3 percent) as defined by the pulp and paper industry standards. The fiber will have a water-holding capacity of not less than 900 grams of water per 100 grams of fiber.

J-12.1.4. The material will be of such character that the fiber will be dispersed into a uniform slurry when mixed with water. It will be nontoxic to plant or animal life.

J-12.1.5. The material will contain a green dye, noninjurious to plant growth, in order to permit easy visual monitoring during application.

J-12.2. Mulch without Tackifier. Specifications are the same as for paragraph J-12.1., above except that J-12.1.2. should be omitted.

APPENDIX K
 SPECIFICATION GUIDELINES FOR HYDRO-MULCHING

K-1. General. Hydro-mulching work shall be accomplished (only) in the (spring) () planting season from () to (), when satisfactory results can be expected. All seeding operations must be completed by the last day of the planting season. When conditions such as drought, excessive moisture, high winds, or other factors prevail to such an extent that satisfactory results are not likely to be obtained. The Contracting Officer may, at his own discretion, stop any phase of the work. The work shall be resumed only when, in the opinion of the Contracting Officer, the desired results are likely to be obtained. AU hydro-mulching operations shall be accomplished on areas indicated on the drawings and as specified herein.

K-2. Materials.

K-2.1. Seed. All seed used shall be labeled in accordance with U.S. Department of Agriculture Rules and Regulations under the Federal Seed Act in effect on the date of invitation for bids. All seed shall be furnished in sealed standard containers unless exception is granted in writing by the Contracting Officer. Seed which has become wet, moldy, or otherwise damaged in transit or in storage shall not be acceptable. The minimum percentage by weight of pure live seed in each lot of seed shall be as follows under "Minimum % pure live seed required," and seed shall be planted at the rate per acre indicated under "Pounds pure live seed required per acre."

Kind of seed	Minimum % pure live seed required	Pounds pure live seed required per acre
--------------	-----------------------------------	---

Total pounds pure live seed per acre

Note: Pure live seed = % Germination X % Purity.

The seed or seed mixture shall contain not more than 2.00% weed seed of which no noxious weed seed shall be allowed.

K-2.2. Fertilizer for Initial Fertilizing. Fertilizer for initial fertilizing shall be (note: use nitrogen-phosphorus-potassium ratio based upon a laboratory soil test) pelleted, uniform in composition, free-flowing, and suitable for application with approved equipment. The fertilizer shall be delivered to the site in bags or other

convenient containers, each fully labeled, conforming to the applicable state fertilizer laws, and bearing the name, trade name or trademark, and warranty of the producer.

K-2.3. Fertilizer for Refertilizing. Fertilizer for refertilizing shall be (note: use nitrogen-phosphorus-potassium ratio of 0-1-1 for grass and legume mixtures and ratio of 1-0-0 for grass mixtures based upon a laboratory soil test) uniform in composition, freeflowing, and suitable for application with approved equipment. The fertilizer shall be delivered to the site in bags or other convenient containers, each fully labeled, conforming to the applicable state fertilizer laws, and bearing the name, trade name or trademark, and warranty of the producer.

K-2.4. Wood Cellulose Fiber Mulch. Wood cellulose fiber supplied shall qualify for satisfactory use with the hydraulic application of grass seed and fertilizer. It shall be processed in such a manner that it shall not contain germination or growth inhibiting factors. It shall be dyed an appropriate color to allow visual monitoring of its application. The wood cellulose fibers shall have the property of becoming evenly dispersed and suspended when agitated in water. When sprayed uniformly on the surface of the soil, the fibers shall form a blotter-like ground cover, which readily absorbs water and allows infiltration to the underlying soil. Weight specifications from suppliers, and for all applications, shall refer only to air dry weight of the fiber, a standard equivalent to 10 percent moisture. The mulch material shall be supplied in package having a gross weight not in excess of 100 pounds and shall be marked by the manufacturer to show the air dry weight content. Suppliers shall be prepared to certify that laboratory and field testing of their product has been accomplished, and that it meets all of the foregoing requirements.

K-2.5. Water. Water shall be free from oil, acid, alkali, salt, and other substances harmful to growth of grass. The water source shall be subject to approval prior to use.

K-3. Hydraulic Mulching Equipment and Procedures.

Hydraulic equipment used for the application of fertilizer, seed, and slurry of prepared organic mulch shall have a built-in agitation system with an operating capacity sufficient to agitate, suspend, and homogeneously mix a slurry containing up to 40 pounds of fiber plus 70 pounds of fertilizer solids for each 100 gallons of water. The slurry distribution lines shall be large enough to prevent stoppage. The discharge line shall be equipped with a set of hydraulic spray nozzles which provide even distribution of the slurry on the areas to be seeded. The slurry tank shall have a minimum capacity of 1,000 gallons and shall be mounted on a traveling unit which may be either self-propelled or drawn with a separate unit which shall place the slurry tank and spray nozzles within sufficient proximity to the areas to be seeded so as to provide uniform distribution without waste. The Contracting Officer may authorize equipment with smaller tank capacity provided that the equipment has the necessary agitation system and sufficient pump capacity to spray the slurry in a uniform coat.

K-4. Inspection and Test.

K-4.1. Seed. The Contracting Officer shall be furnished two signed copies of a statement from the vendor certifying that each container of seed delivered is labeled in accordance with the Federal Seed Act and is at least equal to requirements previously specified. This certification and copies of the official seed analysis or official seed tags shall be obtained from the vendor and shall be furnished on or with all copies of seed invoices. Invoices, certifications, and seed analysis shall be furnished prior to commencement of planting operations. Each lot of seed may be resampled and retested, in accordance with latest Rules and Regulations under the Federal Seed Act, at the discretion of the Contracting Officer. Such resampling and retesting shall be made by or under the supervision of the Contracting Officer. If these tests reveal the seed to be below the specified pure live seed content, the contractor shall be required to plant additional seed to compensate for the deficiency at no additional cost to the Government. The seed retests shall be conducted by the State Seed Laboratory. Allowance shall be made for the actual pure live seed content of the specified grasses in determining the actual planting rate. Seed shall have been tested for germination not more than 6 months prior to delivery to the site.

K-4.2. Fertilizers. Two signed copies of invoices shall be furnished. Invoices shall show quantities and grade of each fertilizer furnished. Samples of each lot of fertilizer shall be tested upon request of the Contracting Officer. Sampling and testing shall be in accordance with Official Methods Analysis of the Association of Official Analytical Chemists, at the discretion of the Contracting Officer.

The empty fertilizer bags shall be retained, and upon completion of the project, a final check of total quantities of fertilizer used shall be made against the total area treated. If minimum rates of application have not been met, additional quantities of these materials to make up minimum application specified shall be distributed as directed.

K-4.3. Mulch. At least five days prior to commencement of hydro-mulching operations the contractor shall notify the Contracting Officer of the sources from which the mulch materials are available and the quantities thereof, and representative samples of the materials proposed to be used shall be furnished for approval. Six signed copies of invoices showing quantities of bags and total weight shall be furnished the Contracting Officer at delivery of each load of mulch.

K-4.4. Water. In the event there is any question about the suitability of the water for use in the hydraulic application of mulch, grass seed, and fertilizer, the Contractor, at his own expense, shall have an analysis made by an approved laboratory to determine the nature and concentration of impurities present.

K-5. Seedbed preparation.

K-5.1. General. Equipment necessary for the proper preparation of the ground surface and for handling and placing all required materials shall be on hand and in good condition and shall be approved before the work is started. The contractor shall demonstrate to the Contracting Officer before starting work that the application of the materials required shall be made at the specified rates.

K-5.2. Grading. Grades on the areas to be seeded shall be maintained in a true and even condition. Maintenance shall include any necessary repairs to previously graded areas.

K-5.3. Tilling. Tillage shall be accomplished in such manner as to prepare an acceptable seed bed. The contractor shall utilize tractors with adequate horsepower and heavy-duty tillage equipment in accomplishing the specified tillage operations. All areas shall be tilled with a heavy-duty disk harrow, followed by tilling and smoothing with equipment

such as spring or spike-tooth harrow, meeker harrow, and cultipacker. All areas shall be left smooth for ease of mowing. Depth of tillage shall be (4) () inches. All seed bed preparation on sloping land shall be performed on the contour to reduce soil loss.

K-5.4. Cleanup. Prior to hydro-mulching, the surface shall be cleared of All stones, stumps, or other objects larger than 1 to 1 1/2 inches in thickness or diameter and of All roots, brush, wire, grade stakes, and other objects that might be a hindrance to maintenance operations.

K-6. Application of Fertilizer. Fertilizer of the type specified in paragraph K-2.2 shall be distributed uniformly over the areas indicated to be seeded at a rate based on a laboratory soil test. Fertilizer shall be applied simultaneously with seed and mulch in the hydro-mulching equipment using the specified rate of application. Additional fertilizer shall be applied in accordance with paragraph K-9.

K-7. Hydro-mulching.

K-7.1. General The contractor shall conduct hydro-mulching equipment calibration tests in the presence of the Contracting Officer as a means of determining the coverage per load to plant the seed at the specified rates. If unplanted skips and areas are noted after germination and growth of the grass, the contractor shall be required to hydro-mulch the unplanted areas with the grasses that were to have been planted at no additional cost to the Government.

K-7.2. Seeding. The equipment to be used and the methods of planting shall be subject to the inspection and approval of the Contracting Officer prior to commencement of planting operations. The seed shall be sprayed on with the mulching equipment specified in paragraph K-3, in combination with fertilizer and mulch.

K-8. Application of Mulch. The application of the wood cellulose fiber mulch slurry shall be made with the mulching equipment specified in paragraph K-3, and shall be accomplished immediately upon completion of the final tillage (para. K-5.3), the last phase of which shall be with a cultipacker. The wood cellulose fiber mulch shall be applied at the rate of (1,500 to 3,000) () pounds per acre in combination with water, fertilizer, and the seed and shall be sprayed over the soil in a uniform coat.

K-9. Refertilizing. The planted areas shall be refertilized 30 days after commencement of maintenance operations using fertilizer specified in paragraph K-2.3. Fertilizer shall be applied at the rate of (note: coordinate with paragraph K-6 in determining application rate) pounds

per acre using a fertilizer distributor when the vegetation is dry.

K-10. Maintenance of Turfing Work.

K-10.1 General. It shall be the responsibility of the contractor to maintain all hydro-mulched areas during the planting period and for an additional period of not less than 60 calendar days after All hydro-mulching is complete. Maintenance shall consist of protection, replanting, refertilizing, mowing, maintaining existing grades, and repairing erosion damage. Areas on which an acceptable stand of grass is not present at the end of the 60-day period shall be maintained by the contractor until an acceptable stand of grass is present at no additional cost to the Government.

K-10.2 Protection. The hydro-mulched areas shall be protected against traffic or other use immediately after hydro-mulching is completed. Protection of these areas shall be maintained until completion of All work under this contract.

K-10.3 Replanting. A stand of grass shall be defined as live (Bermuda grass) () plants from seed occurring at the rate of not less than (rate to be determined by an agronomist in project area) () growing plants per square foot. Areas on which this requirement is not met within 60 days after the original planting shall be reseeded, refertilized, and remulched as specified in paragraphs K-5 through K-7, at the applicable contract price and shall continue to be replanted until a stand is obtained.

K-10.4 Mowing. Vegetation shall be kept under control by mowing. Any time the weed or grass growth reaches a height of 3 to 4 inches on improved grounds and 4 to 6 inches on unimproved grounds, hydro-mulched areas shall be mowed. Using approved mowing equipment with sharp blades at all times, the mowing height shall be set so that not more than one-third of the leaf is removed at any one clipping. Proper height for the grass type, as determined by (the Contracting Officer) () shall be maintained.

K-10.5. Maintaining Grades and Repairing Erosion Damage. It shall be the responsibility of the contractor to maintain the original grades of the slopes after commencement of planting operations and during the specified maintenance period. Any damage to the finished surface from the contractor's operations shall be

promptly repaired. In the event erosion occurs from rainfall or other causes, such damage shall be promptly required. Ruts, ridges, tracks, and other surface irregularities shall be corrected and areas replanted, where required, prior to acceptance.

K-11. Measurement. The unit of measurement of hydro-mulching shall be the acre. The area to be paid for shall be the acreage actually prepared, fertilized, hydro-mulched, refertilized, and maintained as specified, computed to the nearest tenth of an acre.

K-12. Payment. Hydro-mulching shall be paid for at the applicable contract unit price per acre for "Hydro-mulching", which payment shall be full compensation for all cost of hydro-mulching as specified herein.

K-13. Contractor Quality Control.

K-13.1. The Contractor shall inspect for compliance with contract requirements and record the inspection of all operations including, but not limited to, the following-

K-13.1.1. Seedbed preparation and fertilizer application-rate and uniformity.

K-13.1.2. Hydro-mulch application-rate, uniformity; cultipacking.

K-13.1.3. Refertilization-rate and uniformity.

K-13.2. A copy of the records of inspections and tests, as well as the records of corrective action taken, shall be furnished to the Government representative at the job site on the following work day or less frequently, as approved by the Contracting Officer.

Index

	<i>Paragraph</i>
Acidity tests	5-4.2.5.
Agricultural leases	17-1
Airfield Maintenance:	
Traffic control	15-8.2
Vegetation control	15-8.1
Alkalinity tests	5-4.2.5
Amendments, soil	
Gypsum	8-3.2
Limestone	8-3.1
Peat	8-3.4
Soil mix	8-3.5
Sulphur	8-3.3
Topsoil and oil x	8-3.6
Antenna facilities maintenance	15-10
Anti-desiccants	15-6.16
Classification of Grounds	2-6
Climatic factors:	
Light	4-1.3
Precipitation	4-3
Regions	4-2
Temperatures	4-1.1
.....	4-4
Water	4-1.2
Wind	4-1.4
Contracts, Service	17-2
Diseases	9-3
Drainage:	
Design	6-4
Construction	6-4
Maintenance	6-5
Systems	6-3
Watershed	6-2
Environmental Considerations:	
Construction actions	7-5.1
Pre-construction actions	7-5.2
Equipment:	
Kinds	12-1.2
Maintenance	12-2.1
.....	12-2.2
.....	12-2.3
Erosion:	
Control	7-2
Dust	7-2
Sand dune control	7-4
Shoreline stabilization	7-3
Water	7-1
Wind	7-2
Fertilizers:	
Kinds	8-2.3
Plant food element	8-1
Precautions in use	48-2.3
Slow release	8-2.3.7
Types	8-2.2
Where used	8-2.1
Fertilizing	
General	8-2.1
Grass	15-5.12
Trees and shrubs	15-6.15

Paragraph

Fire (vegetated areas):	
Presuppression-	
Cooperative agreements	10-2.11
Detection	10-2.1
Equipment	10-2.7
Firebreaks	10-2.4
Hazard reduction	10-2.3
Manpower.....	10-2.8
Protection plan	10.2.10
Training	10-2.2
Prevention.....	10-1
Reports	10-4
Suppression-	
Aerial attack	1-3.2
Mop-up.....	10-3.3
Tactics.....	10-3.1.3
Fruit inhibitors.....	15-6.17
Fungicides.....	9-3.1
Golf Course:	
Design	15-7.1
Maintenance.....	15-7.3
Planning	15-7.2
Grasses:	
Airfields	15-5.7
Ammunition magazines, antenna facilities, embankments, training areas	15-5.8
Drought resistant perennials.....	15-5.3.3
Lawn-type by zones.....	15-5.5
Miscellaneous	15-5.3.5
Northern perennials.....	15-5.3.2
Planting zones.....	15-5.4
Recreation areas and parade grounds.....	15-5.6
Southern perennials	15-5.3.1
Species to use.....	15-5.3
Temporary or annual	15-5.3.4
Unimproved grounds	15-5.9
Grounds, classification	2-6
Gypsum.....	8-3.2
Herbicides (see Vegetation control)	
Insects	9-2
Irrigation:	
Design.....	16-1.4
.....	16-5
Maintenance.....	16-6.3
New turf.....	15-5.18
Operating procedures.....	16-6.2
Requirements.....	16-3
System selection	16-4
Water Conservation.....	16-2.3
Water sources	16-2
Land reclamation.....	15-12.2
.....	15-12.3
Landscape plantings:	
Design.....	15-6.2
Ground elevations	15-6.18
Maintaining plantings.....	11 through
.....	15-6.14
Plant lists-	
Ground covers.....	15-6.6
Trees and shrub	15-6.5
Plant material standards.....	15-6.7
Planting procedures	15-6.9

	<i>Paragraph</i>
Planting seasons	8
Windbreak plantings	15-6.10
Zones	15-6.4
Land use capabilities	5-3
Legumes:	
Inoculation	15-5.15.1
Miscellaneous	15-5.3.6
Planting zones	15-5.4
Lime	8-3.1
Magazine (earth covered) maintenance	15-11
Mowing:	
General guidelines	15-13.2
Height	15-13.5
Preliminary	15-13.1
Preliminary	15-5.19.1
Mulches:	
Inorganic	15-5.16.1.2
Organic	15-5.16.1.1
Multiple use	2-7
Natural resources management plan:	
Annual increments	3-2
Long range parts	3-2
Peat	8-3.4
Pesticides (see Safety)	
Pests, animal	9-4
Planting procedures:	
Fertilizing	15-5.12
Grading	15-5.10
Hydro-mulching	15-5.16
Liming	15-5.11
Mulch classification	15-5.12
Mulching	15-5.16.1
Mulching	15-5.16
Seasons for planting	15-5.14
Seed	15-5.13
Seedbed preparation	15-5.11
Seeding	15-5.15.1
Sodding	15-5.17
Sprigging	15-5.15.2
Tilling	15-5.10
Poisonous plants (see Safety)	
Pollutants:	
Air	13-3
Soil water and foliar	13-2
Preventive maintenance	15-4
Roadside vegetation maintenance	15-9.1
Safety:	
Health and environment	14-2
Pesticides	14-4
Poisonous plants	14-5
Protective clothing and equipment	14-3
Sanitary landfills (completed)	15-12.1
Service contracts	17-2
Soil:	
Amendments	8-3
Analysis	5-1.2
Capabilities, land use	5-5.3
Depth	5-2
Fertility	5-4
Surveys	5-5

	<i>Paragraph</i>
Tests	5-4.2
Texture	5-3
Specialists, land management	2-5
Sulphur.....	8-3.3
Tests, acidity	5-4.2.5
Tests, alkalinity	5-4.2.5
Vegetation control:	
Cultural practices.....	11-2
Growth retardants.....	11-4
Herbicides	11-3
Weed, types	11-1
Weed control (see Vegetation control)	

INDEX 4

By Order of the Secretaries of the Army, the Navy, and the Air Force:

Official:

ROBERT M. JOYCE
*Brigadier General United States Army
The Adjutant General*

E. C. MEYER
*General United States Army
Chief of Staff*

Official:

JAMES L. WYATT, JR., *Colonel USAF*
Director of Administration

W. M. ZOBEL
*Rear Admiral CEC, US Navy Commander
Naval Facilities Engineering Command*

LEW ALLEN, JR., *General USAF*
Chief of Staff

DISTRIBUTION:

Army: To be distributed in accordance with DA Form 12-34B, requirements for TM 5-600 Series: Facilities Engineering. Maintenance and Operation of Facilities.

Navy: (1 copy each except as noted)

SNL:	A1 (SO-4)	ASN (S&L)
	S3	CNO (OP-45)
	A4A	CHNAVMATIO44)
	FKA1G	COMNAVSEASYSYSCOM
	FKA1F	COMNAVSUPSYSCOM
	FKA1B	COMNAVELEXSYSCOM
	FKA1A	COMNAVAIRSYSCOM
	FKA1C	COMNAVFACENGC (FAC-204) 20 copies each
	A6	CMC (LFF-2) 45 copies each
	FKN5	PWCs (less Yokosuka) 5 copies each
	FKN1	CHESNAVFACENGC (243) 6 copies each, SOUTHNAVFACENGC (243) 5 copies each, NORTHNAVFACENGC (243) 20 copies each, WESTNAVFACENGC (243) 25 copies each, PACNAVFACENGC (243) 5 copies each, LANTNAVFACENGC (243) 35 copies each

Additional copies may be obtained from: US Naval Publications and Forms Center
5801 Tabor Avenue
Philadelphia. PA 19120

Air Force: F

RECOMMENDED CHANGES TO EQUIPMENT TECHNICAL PUBLICATIONS



THEN... JOT DOWN THE DOPE ABOUT IT ON THIS FORM, CAREFULLY TEAR IT OUT, FOLD IT AND DROP IT IN THE MAIL!

SOMETHING WRONG WITH THIS PUBLICATION?

FROM: (PRINT YOUR UNIT'S COMPLETE ADDRESS)

DATE SENT

PUBLICATION NUMBER

PUBLICATION DATE

PUBLICATION TITLE

BE EXACT... PIN-POINT WHERE IT IS

PAGE NO.

PARA-GRAPH

FIGURE NO.

TABLE NO.

IN THIS SPACE TELL WHAT IS WRONG AND WHAT SHOULD BE DONE ABOUT IT:

TEAR ALONG PERFORATED LINE

PRINTED NAME, GRADE OR TITLE, AND TELEPHONE NUMBER

SIGN HERE:

DA FORM 2028-2
1 JUL 79

PREVIOUS EDITIONS ARE OBSOLETE.

P.S.—IF YOUR OUTFIT WANTS TO KNOW ABOUT YOUR RECOMMENDATION MAKE A CARBON COPY OF THIS AND GIVE IT TO YOUR HEADQUARTERS.

PIN: 005250-000